

IE2-180L-B3  
Mounting diagram

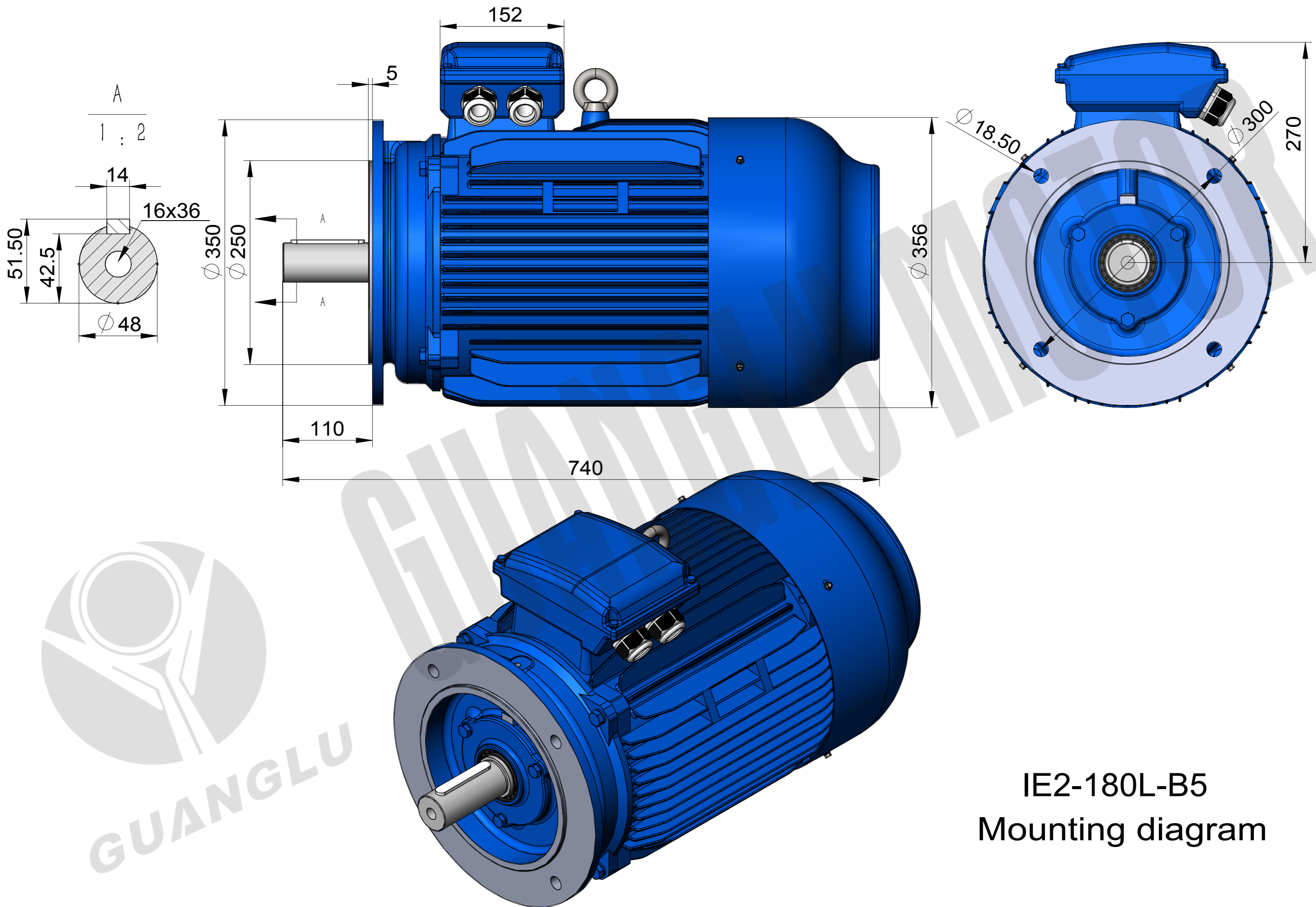

IE2-180L-B5  
Mounting diagram

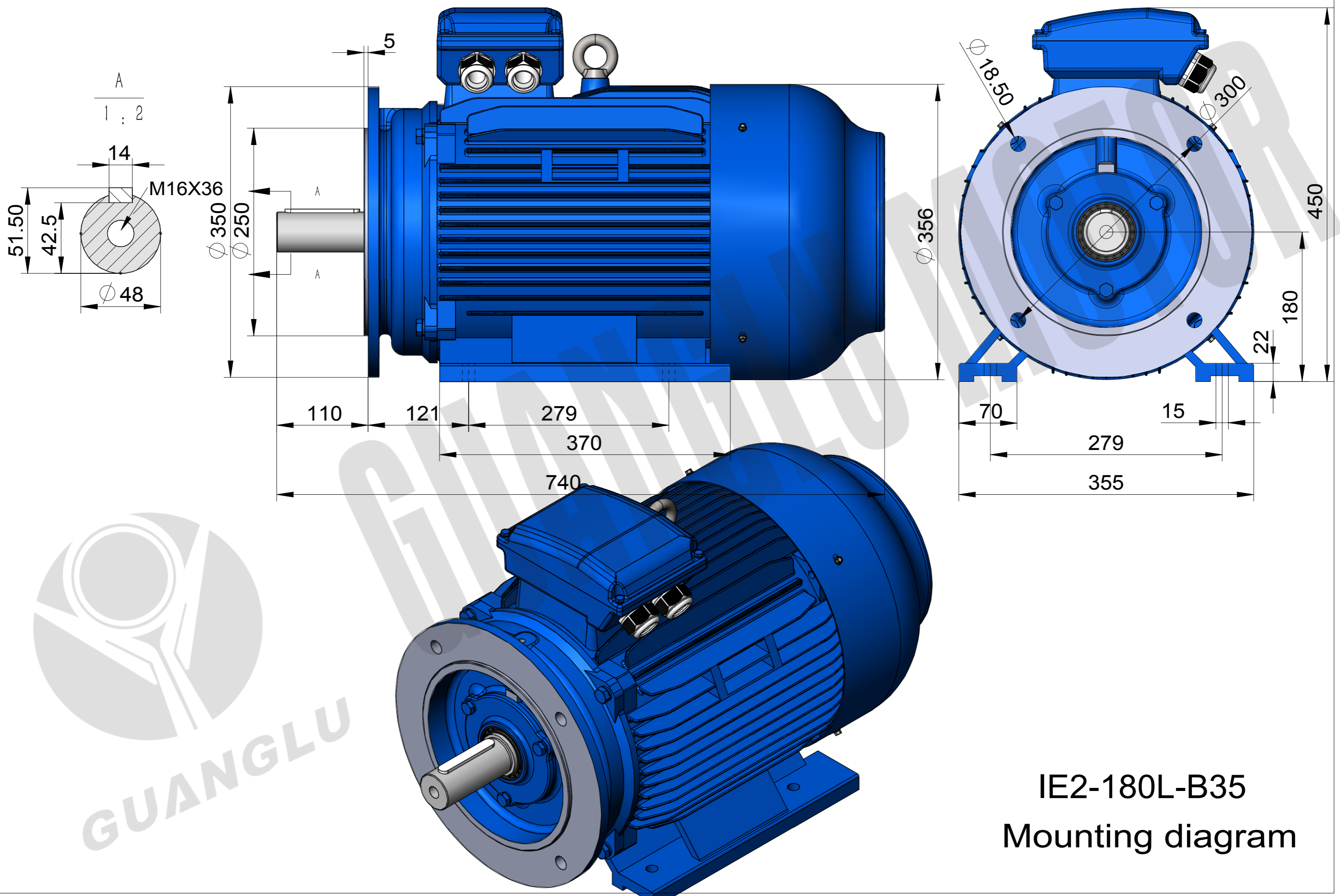

IE2-180L-B35  
Mounting diagram