

Control Circuit Devices, Signal Towers

Product Range Catalog

Command and Indication

Build it in.

WWW.TM2A.PT info@tm2a.pt



WWW.TM2A.PT info@tm2a.pt

EATON
Powering Business Worldwide



TM2A Soluções e Componentes Industriais
Rua Cidade de Viena 2, Parque Ind. Arneiro
2660-456 São Julião do Tojal
PORTUGAL
T: +351 219737330 F: +351 219737339
www.tm2a.pt info@tm2a.pt



Energizing a world that demands more.

We deliver:

- **Electrical solutions** that use less energy, improve power reliability and make the places we live and work safer and more comfortable
- **Hydraulic and electrical solutions** that enable machines to deliver more productivity without wasting power
- **Aerospace solutions** that make aircraft lighter, safer and less costly to operate, and help airports operate more efficiently
- **Vehicle drivetrain and powertrain solutions** that deliver more power to cars, trucks and buses, while reducing fuel consumption and emissions

Discover today's Eaton.

Powering business worldwide

As a global power management company, we help customers worldwide manage the power needed for buildings, aircraft, trucks, cars, machinery and businesses.

Eaton's innovative technologies help customers manage electrical, hydraulic and mechanical power more reliably, efficiently, safely and sustainably.

We provide integrated solutions that help make energy, in all its forms, more practical and accessible.

With 2015 sales of \$20.9 billion, Eaton has approximately 100,000 employees around the world and sells products in more than 175 countries.

Eaton.com

EATON

Powering Business Worldwide

Contents

Moeller™ series

	Page
CAD data	2
Pushbutton-Configurator	3
Modular pilot devices RMQ-Titan (22 mm, 30 mm)	4
M22/M30 system overview	8
Controlled stop/emergency switching off	10
M22 front elements	20
M30 front elements, flat front	38
Contact elements, LED elements	48
Accessories	57
Engineering	73
Technical data	76
Dimensions	84
Compact pilot devices RMQ compact solution (22 mm, 30 mm)	94
C22 complete devices	96
C30 complete devices, flat front	110
Modular pilot devices RMQ16 (18 mm, 25 mm)	122
Q18/Q25 system overview	124
Foot and palm switch FAK	144
FAK system overview	145
Signal towers SL (40 mm, 70 mm)	148
SL4-signal towers – system overview	150
SL7-signal towers – system overview	158
RMQ C22 compact series	180
XV HMI/PLC touch panels	181
Explosion-protected pilot devices (Crouse-Hinds series)	182
Value Added Services	184

WWW.TM2A.PT info@tm2a.pt

WWW.TM2A.PT info@tm2a.pt

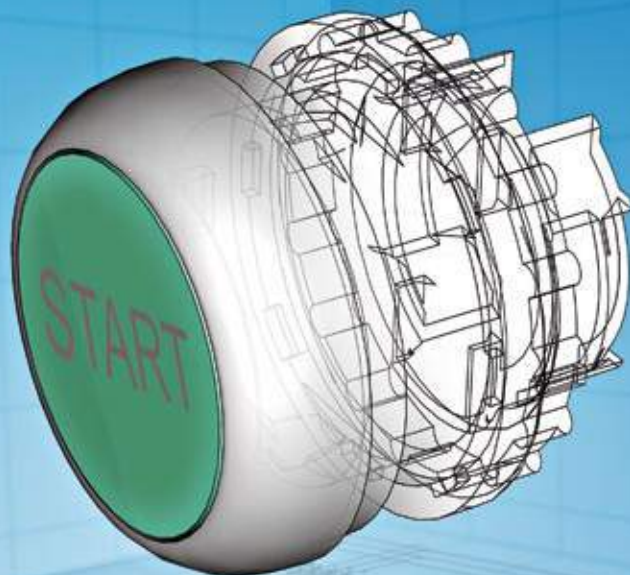

Planning safety and process optimization: CAD data at the click of a mouse!



- 12,900 article data items and macros
- Convenient selection tool
- Version P8



- Models for approx. 15,000 products
- 80 different neutral & native formats

Eaton is providing its customers with CAD data to offer optimum support during planning. Both electrical and mechanical design data can be called up quickly and conveniently from the Internet at any time. This reduces processing times, minimizes errors and thus reduces costs already in the engineering phase of control panels, systems and machinery.

eCAD: Eaton has product data and macros available for EPLAN Electric P8. After downloading the small EPLANSelection program, you will not only be able to select the items you need from a database containing more than 12,900 products, but will also be able to export them and import them into your own EPLAN item database.

mCAD: Eaton makes 2D and 3D data available for more than 15,000 products. Over 80 different neutral and native formats guarantee compatibility with the project engineering systems of the customer. The models can either be integrated directly into the planning software from the Partcommunity Portal on the Internet or via the CADENAS Partsolution software.

www.eaton.eu/cad

The Pushbutton-Configurator – Select Your Products Quickly and Easily!



info@tm2a.pt

WWW.TM2A.PT

info@tm2a.pt

WWW.TM2A.PT

The Pushbutton-Configurator is available online and is designed to help you select and combine a variety of pilot devices, such as those found in the RMQ-Titan series. The configurator is user-friendly and neatly laid out, provides a quick overview of the various ranges of products, and uses intuitive user guidance to show solutions that match your needs. In addition, once all individual components have been selected, the configurator will show the assembled final product. Moreover, the setup pane shows selected products directly, making it much easier for you to configure the right components for your application.

The integrated Label Editor function can be used to create custom labels for pilot devices, enabling you to customize your applications as necessary. Moreover, the configurator also makes it possible to easily configure complete devices that are put together in a custom-tailored manner. Once you configure your pilot devices, you will be shown a convenient parts list that you can then use to easily order all the components you need. Combined with the various images and integrated links to data sheets, these parts lists ensure that you can easily put together the required documentation for your projects.

To use the Pushbutton-Configurator, visit:

www.eaton.eu/config/rmq

Build it in.



RMQ-Titan Pilot Devices Proven and Versatile



Catalog download:
www.eaton.eu/catalog

www.eaton.eu/rmq

The pilot devices in the RMQ-Titan M22 and M30 series are characterized by enormous versatility, making them the perfect solution for a wide variety of applications and processes. In fact, the range of potential applications for which they can be used is further broadened by their high degree of protection. In addition, their ergonomic operators combine stylish design with optimum functionality, and using their new slim contact elements makes it possible to combine RMQ-Titan devices with minimal mounting depths. Finally, their shape and design makes RMQ-Titan pilot devices comfortable and intuitive to use.

The tried and tested M22 product series is now complemented by M30 elements with a slim design. Contact and LED elements are available in two mounting depths for the flush mounting plates for both series. Moreover, the fact that the pilot devices can be connected to the SmartWire-DT communication system makes them ingeniously simple to wire.

Emergency stop buttons in a wide variety of designs are an important element in ensuring that dangers can be safely averted, and accordingly play a key role in protecting personnel and property. Accordingly, the emergency-stop buttons in the RMQ-Titan series are tamper-proof.

Numerous type approvals and classification society approvals ensure that RMQ-Titan devices can be used worldwide.

In short, this comprehensive range of pilot devices is engineered to ensure that your machines, systems, and processes keep running smoothly.

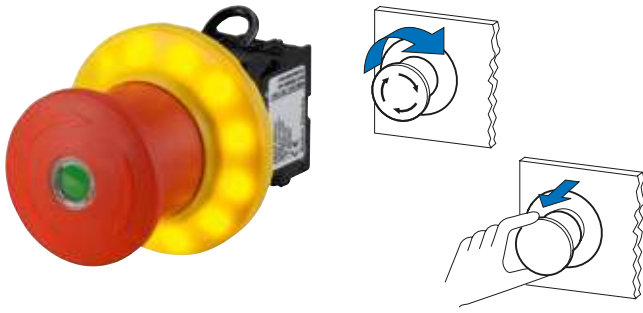

Safe shutdown with RMQ-Titan

The EMERGENCY-STOP or EMERGENCY-OFF buttons are available with and without a key, turn-release, non-illuminated, illuminated with standard LED or with mechanical switch position display (green/red) in the centre of the actuation element. Self-monitoring contact blocks guarantee comprehensive operational safety: even with incorrect installation or after unduly powerful actuation.



Flush RMQ-Titan buttons

RMQ-Titan units with a flush design are the perfect complement to the industry's move towards stylish front panels for machines. These flush pushbuttons feature a modular design and are the perfect match for the RMQ-Titan series, flush contacts, and LED elements. Moreover, the flush transition between their operator and bezel make these units ideal when it comes to sleek looks and cutting-edge applications.



Easy and flexible assembly

RMQ flat front devices are not only characterized by an attractive and sleek design, but also feature the sophisticated mounting system known as RMQ-AFX. When the knurled nut is tightened, a spring element simultaneously ensures that the assembly will automatically adjust to the thickness of the mounting plate being used. RMQ flat front devices are designed for 30.5 mm mounting holes.

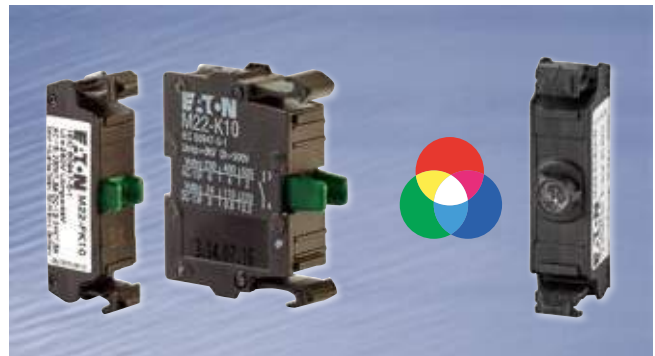

Flush and modular: flat rear elements

These flush contact and LED elements, which have a mounting depth of only 30 mm, are perfect for control panels in which every bit of space counts. They feature a one-of-a-kind modular design when it comes to operators, contacts, LED colors, and accessories, with the flush multi-color LED elements opening a whole new world of possibilities when it comes to intelligent control designs for machines.



Fast, flexible labelling – The Label Editor

The Label Editor is available as one of the functions in the Pushbutton-Configurator. Once you put together your pilot device combinations, you can use this function to make a customized laser inscription on your button plates using your own company or project-specific label, logo, or image – easily, conveniently, and custom-tailored to your needs! www.eaton.eu/config/rmq



High-precision settings made easy

The M22-SWD encoder makes it possible to set extremely precise settings on machines by simply turning it and confirming. Moreover, its modular design, combined with a direct SmartWire-DT connection, allows for maximum installation flexibility and ease of diagnostics. The M22-SWD encoder also completely eliminates any potential extra costs that would normally be associated with the use of an encoder.

M22



1.0 RMQ-Titan pilot devices

1.1 System overview

M22/M30 – System overview	8
M22 – Controlled stop/emergency stop system overview.	10

1.2 Product selection

M22 – Controlled stop/emergency stop complete devices for flush mounting	12
M22 – Controlled stop/emergency stop buttons	13
C22 – Controlled stop/emergency stop complete devices.	15
Controlled stop/emergency stop accessories	16
M22 – Controlled stop/emergency stop legend plates	17
M22 – Stop pushbuttons	19

1.3 System overview

M22 – System overview.	20
--------------------------------	----

1.4 Product selection

M22 – Complete devices	22
M22 – Double actuator pushbuttons	24
M22 – Pushbuttons	25
M22 – Mushroom pushbuttons	27
M22 – Selector switches	28
M22 – Key-operated buttons	29
M22 – Key-operated buttons, configuration kit	30
M22 – Joysticks	31
M22 – 4-way pushbuttons, legend plates	32
M22 – Indicator lights.	33
M22 – Potentiometers, acoustic devices.	34
M22 – Illuminated pushbutton actuators	35
M22 – Illuminated selector switches	37

M30



1.5 System overview	
M30 – Flat Front – System overview	38
1.6 Product selection	
M30 – Pushbuttons (Flat Front)	40
M30 – Selector switches (Flat Front)	41
M30 – Key-operated buttons (Flat Front)	42
M30 – Joysticks, indicator lights (Flat Front)	44
M30 – Illuminated pushbutton actuators (Flat Front)	45
M30 – Illuminated selector switches (Flat Front)	46
M30 – Potentiometers (Flat Front)	47
Mounting adapters, contact elements	48
Contact elements, signal contact actuators	49
Complete modules	50
LED elements	51
Contact elements, LED elements (Flat Rear)	53
SmartWire-DT function elements	54
SmartWire-DT accessories	56
Legend holders, insert labels	57
Button plates for pushbuttons	58
Button plates for mushroom pushbuttons	60
Lenses for indicator lights	62
Button lenses for illuminated pushbutton actuators	64
Flush mounting plates, shrouds	66
Surface mounting enclosures	67
AS-Interface	68
Accessories	69
1.7 Engineering	
Self-monitoring contacts	73
Momentary/maintained configuration, plunger bridges, Label Editor, Pushbutton Configurator	74
LED elements	75
1.8 Technical data	
Contact/LED elements, M22..., M30... pilot devices	76
AS-Interface	78
SmartWire-DT function elements	80
SmartWire-DT accessories	82
1.9 Dimensions	
M22 – Dimensions	84
M22-SWD – Dimensions	90
M30 – Dimensions	91

1.1

RMQ-Titan pilot devices

M22/M30 – System overview

Moeller series

1

System overview

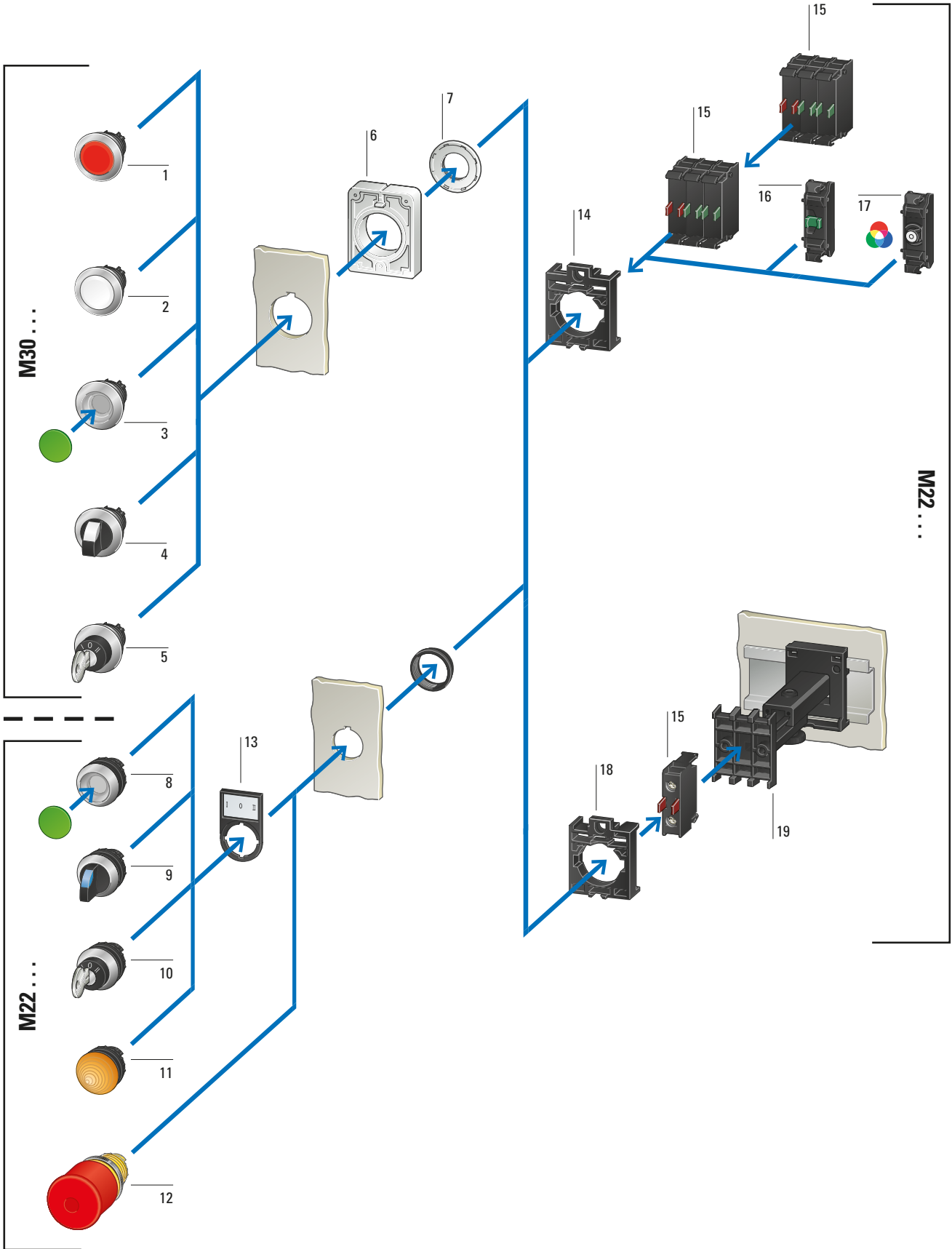

WWW.TM2A.PT info@tm2a.pt

WWW.TM2A.PT info@tm2a.pt

M30 indicator lights	1
Style: flush	
Colors: white, green, red, yellow, blue, orange	
→ Page 44	
M30 pushbuttons	2
Momentary and maintained	
Flush	
Colors: white, green, red, yellow, blue, black, grey	
→ Page 40	
M30 illuminated pushbutton actuators	3
Illuminated pushbutton actuators	
Colors: white, green, red, yellow, blue, orange	
→ Page 45	
M30 selector switches	4
2 and 3 positions	
With rotary head, thumb-grip	
Programmable maintained/momentary action	
Illuminated selector switches with transparent thumb-grip	
Colors: white, green, red, yellow, blue	
→ Page 41	
M30 key-operated buttons	5
For individual lock mechanisms	
2 or 3 positions	
→ Page 42	
RMQ-AFX	6
Anti-rotation tab	
Included with the equipment supplied with M30 front elements	
Threaded rings	7
→ Page 70	
M22 pushbuttons	8
Momentary and maintained	
Flush	
Colors: white, green, red, yellow, blue, black	
Illuminated pushbutton actuators	
Colors: white, green, red, yellow, blue, orange	
→ Page 25	

M22 selector switches	9
2 and 3 positions	
With rotary head, thumb-grip	
Programmable maintained/momentary action	
Illuminated selector switches with transparent thumb-grip	
Colors: white, green, red, yellow, blue	
→ Page 28	
M22 key-operated buttons	10
For individual lock mechanisms	
2 or 3 positions	
→ Page 29	
M22 indicator lights	11
Style: flush, conical	
Colors: white, green, red, yellow, blue, orange	
→ Page 33	
Controlled stop/emergency stop buttons	12
Tamper-proof as defined in ISO 13850/EN 418	
Can be secured with a sealable shroud	
Additional labels, with inscription or blank	
→ Page 14	
Label mounts	13
For insert labels	
Color: black	
Insert labels: aluminum color, with inscription or blank, can be engraved	
→ Page 57	
Mounting adapters	14
For flush mounting	
For contact and LED elements	
→ Page 48	
Contact elements	15
N/C and N/O	
Universal contacts suitable for use with electronic devices	
Safety function implemented with positive opening as defined in IEC/EN 60947-5-1	
Max. 2 levels, each with 3 contact elements	
→ Page 48	

Flat Rear contact elements	16
Cage Clamp with push-in terminals	
→ Page 53	
Flat Rear LED elements	17
Cage Clamp with push-in terminals	
→ Page 53	
Centering adapter	18
For centering pilot device elements when using a telescopic clip	
→ Page 69	
Telescopic clip	19
For adjusting the depth of rear mounting devices in CI and CI-K enclosures and cabinets	
→ Page 69	

1.1

RMQ-Titan pilot devices

M22 – Controlled stop/emergency stop system overview

Moeller series

1

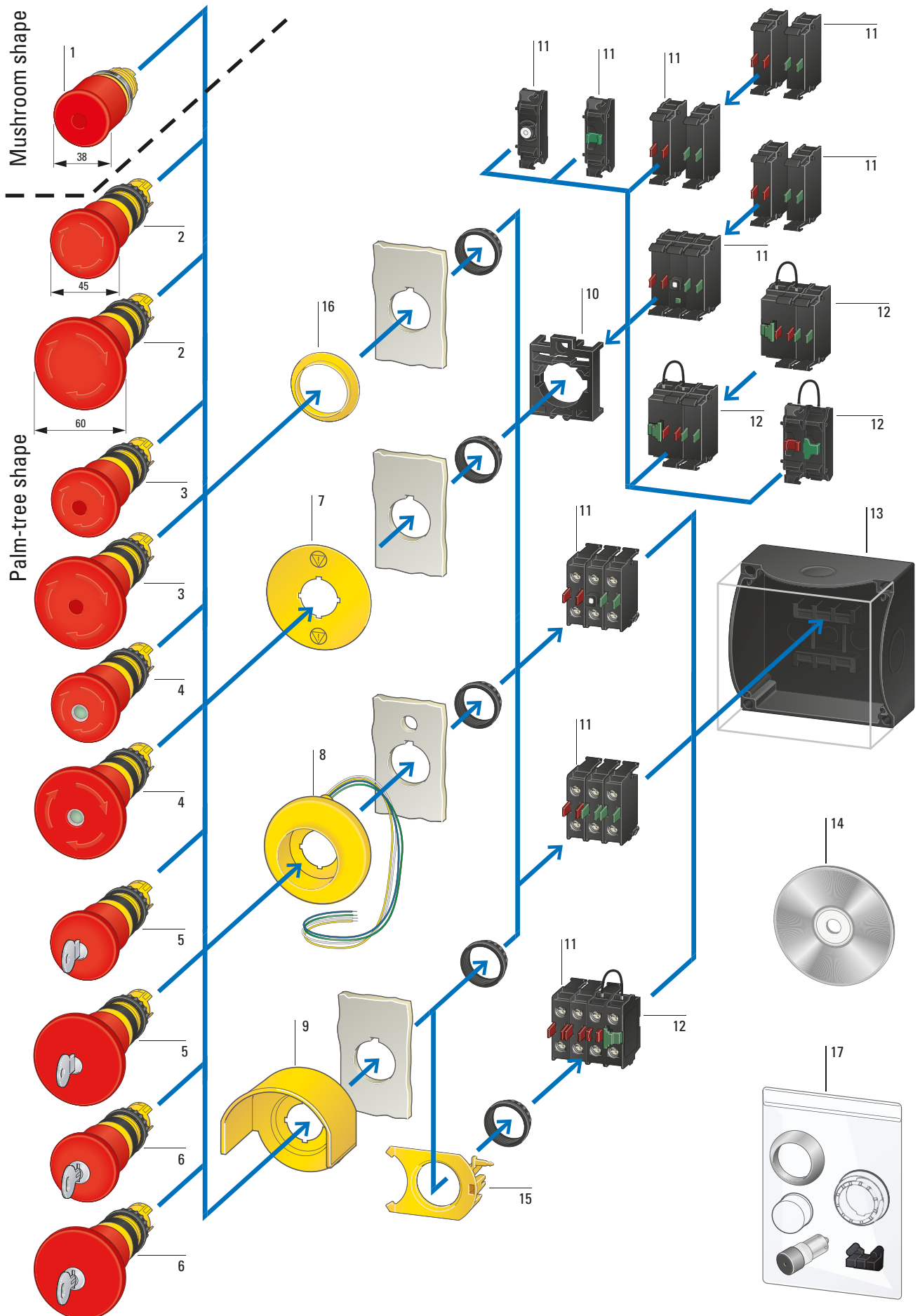

WWW.TM2A.PT info@tm2a.pt

WWW.TM2A.PT info@tm2a.pt

Controlled stop buttons Emergency stop buttons Mushroom-shaped	1
Non-illuminated	
Can be illuminated with LED	
With MS1 - MS20 lock mechanism	
With lock mechanism for master key system	
Tamper-proof as defined in ISO 13850/EN 418	
European Machinery Safety Directive 2006/42/EC	
Can be secured with a sealable shroud	
Additional labels, with inscription or blank	
Twist release	
→ Page 13	
Controlled stop buttons Emergency stop buttons Palm shaped	2
Non-illuminated	
45 mm and 60 mm diameter	
Tamper-proof as defined in ISO 13850/EN 418	
European Machinery Safety Directive 2006/42/EC	
Additional labels, with inscription or blank	
Twist release	
→ Page 14	
Controlled stop buttons Emergency stop buttons Palm shaped	3
Can be illuminated with LED	
45 mm and 60 mm diameter	
Tamper-proof as defined in ISO 13850/EN 418	
European Machinery Safety Directive 2006/42/EC	
Additional labels, with inscription or blank	
Twist release	
→ Page 14	
Controlled stop buttons Emergency stop buttons Palm shaped	4
With mechanical position indicator	
45 mm and 60 mm diameter	
Tamper-proof as defined in ISO 13850/EN 418	
European Machinery Safety Directive 2006/42/EC	
Additional labels, with inscription or blank	
Twist release	
→ Page 14	

Controlled stop buttons Emergency stop buttons Palm shaped	5
With MS1 - MS20 lock mechanism	
45 mm and 60 mm diameter	
Tamper-proof as defined in ISO 13850/EN 418	
European Machinery Safety Directive 2006/42/EC	
Additional labels, with inscription or blank	
Twist release	
→ Page 14	
Controlled stop buttons Emergency stop buttons Palm shaped	6
With Ronis 455 lock mechanism	
45 mm and 60 mm diameter	
Tamper-proof according to ISO 13850/EN 418	
European Machinery Safety Directive 2006/42/EC	
Can be secured with a sealable shroud	
Additional labels, with inscription or blank	
Twist or pull release	
→ Page 14	
Controlled stop legend plates Emergency stop legend plates	7
Round, square, and rectangular types	
Single-language, multi-language, custom inscription possible	
→ Page 17	
Illuminated rings	8
Versions:	
24 V AC/DC, 120 V AC, 230 V AC	
Solid light	
Flashing light with separate driver	
Chaser light with separate driver, 24 V AC/DC	
With three LED rows that can be driven separately	
→ Page 16	
Guard rings	9
For preventing unintended actuation	
For 38 mm and 45 mm designs	
→ Page 16	

Mounting adapters	10
For flush mounting	
For contact and LED elements when using M22-A...	
For contact elements when using M22-A4	
→ Page 48	
Contact elements, indicator lights	11
N/C and N/O	
Universal contacts suitable for use with electronic devices	
Safety function implemented with positive opening as defined in IEC/EN 60947-5-1	
Max. 2 levels, each with 3 contact elements	
→ Page 48	
Self-monitoring contacts	12
Front mounting or base mounting	
1 N/C and 1 N/O in series	
Versions: 2 N/C 1 N/O; 1 N/C 1 N/O	
For safety standards of up to SIL 3 as defined in EN 62061 or performance level e as defined in ISO 13849-1	
→ Page 49	
Enclosures	13
IP67 surface mounting enclosures with up to 6 mounting locations	
IP55 surface mounting enclosures with up to 12 mounting locations	
IP54 flush mounting plates with up to 6 mounting locations	
IP40 shrouds for flush mounting plates	
→ Page 67	
Convenient labeling	14
A laser inscription with any text and/or symbol can be added to all button plates, indicator lights, and add-on legend plates from the RMQ-Silver range of products.	
Download:	
www.eaton.eu/config/rmq	
Keyword: "Pushbutton Configurator	
→ Label Editor function"	
Signal contact actuators for SMC	15
→ Page 49	
Controlled stop/emergency stop legend plates	16
Requiring little space	
→ Page 18	
Accessories	17
→ Page 69	

1

Product selection

Contact configuration: ☹ = Safety function implemented with positive opening as defined in IEC/EN 60947-5-1
 N/O = Normally open contact N/C = Normally closed contact

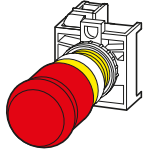

Emergency stop buttons

Tamper-proof as defined in ISO 13850/EN 418
 Pull release
 Max. number of contacts: 4 x M22-(C)K...
 Red mushroom head, yellow base

Qty.	Contact configuration	Contact sequence	Degree of protection	Part no. Article no.	Std. pack	Notes
–	1 N/C ☹		IP66, IP69K	M22-PV/K01 216515	5 units	 BAUART GEPRÜFT TYPE APPROVED
1 N/O	1 N/C ☹		IP66, IP69K	M22-PV/K11 216516	5 units	

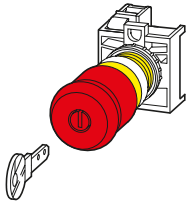

Emergency stop key-release mushroom button

Tamper-proof as defined in ISO 13850/EN 418
 With 1 key, MS1 individual lock mechanism, not suitable for master key systems
 Key release
 Red mushroom head, yellow base

Qty.	Contact configuration	Contact sequence	Degree of protection	Part no. Article no.	Std. pack	Notes
–	1 N/C ☹		IP67, IP69K	M22-PVS/K01 216514	5 units	 BAUART GEPRÜFT TYPE APPROVED

Number of operators Contact configuration: ☹ = Safety function implemented with positive opening as defined in IEC/EN 60947-5-1
 Qty. N/O = Normally open contact N/C = Normally closed contact



Emergency stop buttons

Tamper-proof as defined in ISO 13850/EN 418
 Pull release

Qty.	Contact configuration	Contact sequence	Degree of protection	Part no. Article no.	Std. pack
–	–	2 N/C	IP66, IP69K	M22-PV/KC02/IY 216524	1 unit
–	1 N/O	1 N/C ☹	IP66, IP69K	M22-PV/KC11/IY 216525	

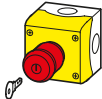

Emergency stop key-release mushroom button









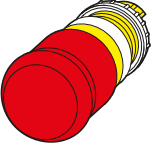

With 1 key
 MS1 lock mechanism



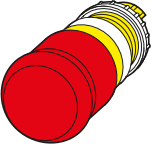

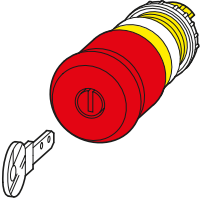





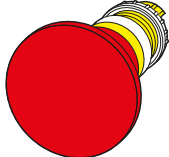



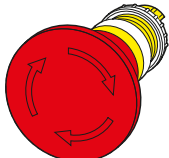

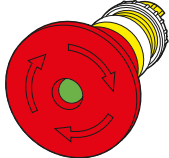

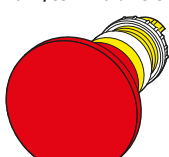

Qty.	Contact configuration	Contact sequence	Degree of protection	Part no. Article no.	Std. pack
1	1 N/O	1 N/C ☹	IP67, IP69K	M22-PVS/KC11/IY 216523	1 unit

Customized complete devices

To order, use form F0315
 → Data sheet in online catalog

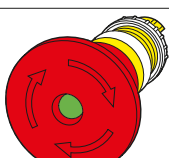

M22-COMBINATION 2010741	1 unit
-----------------------------------	--------

Illumination		Color, mushroom head symbol	Degree of protection	Part no. Article no.	Std. pack
Controlled stop/emergency stop buttons					
Pull release 38 mm button diameter 	Without illumination	Pull release		IP66, IP69K M22-PV 216876	5 units
	Without illumination	Pull release		IP66, IP69K M22-PV-GVP 216877	50 units
	Without illumination	Pull release		IP66, IP69K M22-PV-ESS 178983	5 units
	Can be illuminated with LED element	Pull release		IP66, IP69K M22-PVL 216878	
Twist release 38 mm button diameter 	Without illumination	Twist release		IP67, IP69K M22-PVT 263467	5 units
	Can be illuminated with LED element	Twist release		IP67, IP69K M22-PVLT 263469	
Key release 38 mm button diameter with 1 key 	Without illumination	MS1 individual lock mechanism Not suitable for master key systems		IP67, IP69K M22-PVS 216879	5 units
	Without illumination	MS2 - MS20 individual lock mechanism Not suitable for master key systems * → 2, ..., 20 (i.e.: M22-PVS-MS2, ..., M22-PVS-M20)		IP67, IP69K M22-PVS-MS* 216880	1 unit
	Without illumination	Suitable for master key systems To order, use form MZ047002ZU (formerly F0276) → Data sheet in online catalog Delivery will take approx. 4 to 6 weeks For master key systems, please refer to → Page 30		IP67, IP69K M22-PVS-SA(*)-* 104826	

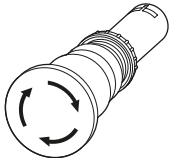
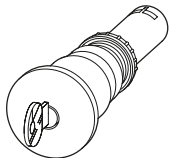
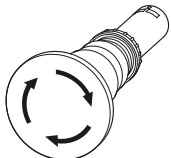
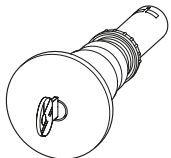
	Illumination		Mushroom head color	Part no. Article no.	Std. pack
Controlled stop/emergency stop buttons, IP67, IP69K					
Pull release Palm, 45 mm diameter 	Without illumination			M22-PV45P 152862	1 unit
	Without illumination	With mechanical position indicator Green position indicator → Button not activated Red position indicator → Button activated		M22-PV45P-MPI 152863	
	Can be illuminated with LED element			M22-PVL45P 152860	
Twist release Palm, 45 mm diameter 	Without illumination	–		M22-PVT45P 121462	1 unit
	Can be illuminated with LED element	–		M22-PVLT45P 121460	
Key release Palm, 45 mm diameter with 1 key 	Without illumination	With mechanical position indicator Green position indicator → Button not activated Red position indicator → Button activated		M22-PVT45P-MPI 121463	
	Without illumination	MS1 individual lock mechanism Not suitable for master key systems		M22-PVS45P-MS1 121468	1 unit
	Without illumination	MS2 - MS20 individual lock mechanisms Not suitable for master key systems * → 2, ..., 20 (i.e.: M22-PVS45P-MS2, ..., M22-PVS45P-MS20)		M22-PVS45P-MS* 121470	
	Without illumination	Ronis 455 individual lock mechanism Not suitable for master key systems		M22-PVS45P-RS 121466	
Controlled stop/emergency stop buttons, IP67, IP69K					
Pull release Palm, 60 mm diameter 	Without illumination			M22-PV60P 152864	1 unit
	Without illumination	With mechanical position indicator Green position indicator → Button not activated Red position indicator → Button activated		M22-PV60P-MPI 152865	
	Can be illuminated with LED element			M22-PVL60P 152861	
Twist release Palm, 60 mm diameter 	Without illumination	–		M22-PVT60P 121464	
	Can be illuminated with LED element	–		M22-PVLT60P 121461	
Key release Palm, 60 mm diameter with 1 key 	Without illumination	With mechanical position indicator Green position indicator → Button not activated Red position indicator → Button activated		M22-PVT60P-MPI 121465	
	Without illumination	MS1 individual lock mechanism Not suitable for master key systems		M22-PVS60P-MS1 121469	
	Without illumination	MS2 - MS20 individual lock mechanisms Not suitable for master key systems * → 2, ..., 20 (i.e.: M22-PVS60P-MS2, ..., M22-PVS60P-MS20)		M22-PVS60P-MS* 121471	
	Without illumination	Ronis 455 individual lock mechanism Not suitable for master key systems		M22-PVS60P-RS 121467	

	Mushroom head color	Contact configuration		Part no. Article no.	Std. pack
		N/O = Normally open contact	N/C = Normally closed contact		
Controlled stop/emergency stop buttons, IP67, IP69K					
Twist release Palm, 45 mm diameter 	Without illumination		2 N/C ⊕	C22-PVT45P-K02 121611	1 unit
	Without illumination		1 N/O	1 N/C ⊕	
Key release, MS1 Palm, 45 mm diameter 	Without illumination		2 N/C ⊕	C22-PVS45P-MS1-K02 121619	
	Without illumination		1 N/O	1 N/C ⊕	
Twist release Palm, 60 mm diameter 	Without illumination		2 N/C ⊕	C22-PVT60P-K02 121621	
	Without illumination		1 N/O	1 N/C ⊕	
Key release, MS1 Palm, 60 mm diameter 	Without illumination		2 N/C ⊕	C22-PVS60P-MS1-K02 121613	
	Without illumination		1 N/O	1 N/C ⊕	

Notes ⊕ Safety function implemented with positive opening as defined in IEC/EN 60947-5-1





	RAL number	Degree of protection	Part no. Article no.	Std. pack
Guard rings				
Makes accidental actuation more difficult				
	RAL 1004	IP65	M22-XGPV 231273	1 unit
	RAL 1004	IP65	M22-XGPV3 177047	
Sealable shroud				
For devices with a 38 mm button diameter Transparent with detachment position; can be reused after controlled stop/emergency stop/stop Adjacent holes must be sealed with M22(S)-B blanking plugs in a 30 x 50 grid				
	–	IP65	M22-PL-PV 216397	2 units
LED-luminous rings				
Yellow with yellow LEDs → Engineering, Page 75 (circuit diagrams)				
60 mm diameter 24 V AC/DC Three groups, with 4 LEDs each (connected in series), that can be driven separately (e.g., for a chaser light sequence)			M22-XPV60-Y-24 121477	1 unit
60 mm diameter 120 V AC One group of 8 LEDs (connected in series)			M22-XPV60-Y-120 121476	1 unit
60 mm diameter 230 V AC One group of 8 LEDs (connected in series)			M22-XPV60-Y-230 138280	1 unit
Customized complete devices				
To order, use form F0315 → Data sheet in online catalog				
			M22-COMBINATION 2010741	1 unit

Note: Contact elements → Page 48

Inscription Language Color Part no. Article no. Std. pack

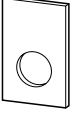
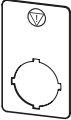
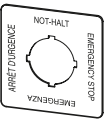
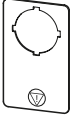

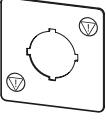

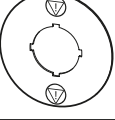
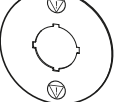
Controller stop legend plates, IP66





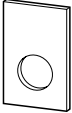
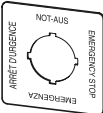

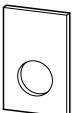
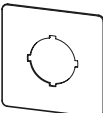
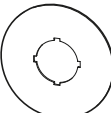

Black lettering

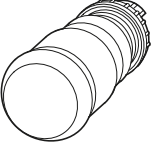
33 x 50 mm 	NOT-HALT	de	●	M22-XZK1-D99 121089	10 units
	Arresto di emergenza	it	●	M22-XZK1-I99 121370	
	HÄTÄPYSÄYTYS	fi	●	M22-XZK1-SF99 121371	
33 x 50 mm 	Symbol (5638) for controlled stop	–	●	M22-XZK-ESS 180470	
50 x 50 mm 	Four languages	de, en, fr, it	●	M22-XYK11 121373	
33 x 50 mm 	Symbol (5638) for controlled stop	–	●	M22-XZK-ESS2 180474	
90 mm diameter 	Four languages	de, en, fr, it	●	M22-XAK11 121085	
	Four languages	de, en, es, pt	●	M22-XAK12 121086	
	Four languages	de, en, nl, fr	●	M22-XAK13 121087	
	Four languages	en, sv, fi, da	●	M22-XAK14 121088	
50 x 50 mm 	Symbol (5638) for NOT-HALT	–	●	M22-XYK-ESS 180471	
60 mm diameter 	Four languages	de, en, fr, it	●	M22-XBK11 121372	
90 mm diameter 	Symbol (5638) for controlled stop	–	●	M22-XAK-ESS 180469	
60 mm diameter 	Symbol (5638) for controlled stop	–	●	M22-XBK-ESS 180472	

M22 – Controlled stop/emergency stop legend plates

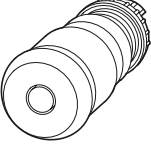
1

Inscription	Language	Color	Part no. Article no.	Std. pack
Emergency stop legend plates, IP66				
Black lettering				
33 x 50 mm 	NOT-AUS	de	● M22-XZK-D99 216471	10 units
	Emergency Stop	en	● M22-XZK-GB99 216472	
	Arrêt d'urgence	fr	● M22-XZK-F99 216473	
	EMERGENZA	it	● M22-XZK-I99 216474	
	NOODSTOP	nl	● M22-XZK-NL99 216475	
	NÖDSTOPP	sv	● M22-XZK-S99 216476	
	HÄTÄ-SEIS	fi	● M22-XZK-SF99 216477	
	NØDSTOP	da	● M22-XZK-DK99 216478	
50 x 50 mm 	–	de, en, fr, it	● M22-XYK1 216484	
90 mm diameter 	–	de, en, fr, it	● M22-XAK1 216465	
	–	de, en, es, pt	● M22-XAK2 216466	
	–	de, en, nl, fr	● M22-XAK3 216467	
	–	en, sv, fi, da	● M22-XAK4 216468	
60 mm diameter 	Four languages	de, en, fr, it	● M22-XBK1 216483	
Controlled stop/emergency stop legend plates				
33 x 50 mm 	With customized Label Editor inscription – → Engineering, Page 74	–	● M22-XZK-* 216479	10 pieces
	Blank	–	● M22-XZK 216470	
50 x 50 mm 	With customized Label Editor inscription – → Engineering, Page 74	–	● M22-XYK-* 231181	
	Blank	–	● M22-XAK 216464	
90 mm diameter 	With customized Label Editor inscription – → Engineering, Page 74	–	● M22-XAK-* 216469	
	Blank	–	● M22-XBK 216464	
60 mm diameter 	With customized Label Editor inscription – → Engineering, Page 74	–	● M22-XBK-* 231762	
	Blank	–	● M22-XBK 269580	
40 mm diameter 	Blank, for small installation spaces	–	● M22-XAK40 177703	

	Mushroom head color	Degree of protection	Part no. Article no.	Std. pack
Stop pushbuttons				
	Non-illuminated, pull release	 IP66, IP69K	M22S-PV 225528	5 units
	Non-illuminated, twist release	 IP67, IP69K	M22S-PVT 271499	
	Non-illuminated, twist release	 IP67, IP69K	M22Y-PVT 147403	
	Illuminated, pull release	 IP66, IP69K	M22S-PVL 230962	
	Illuminated, twist release	 IP67, IP69K	M22S-PVLT 271540	
Guard ring for stop pushbutton				
	-	 IP65	M22G-XGPV 271610	1 unit

1.3

RMQ-Titan pilot devices

M22 – System overview

Moeller series

1

System overview

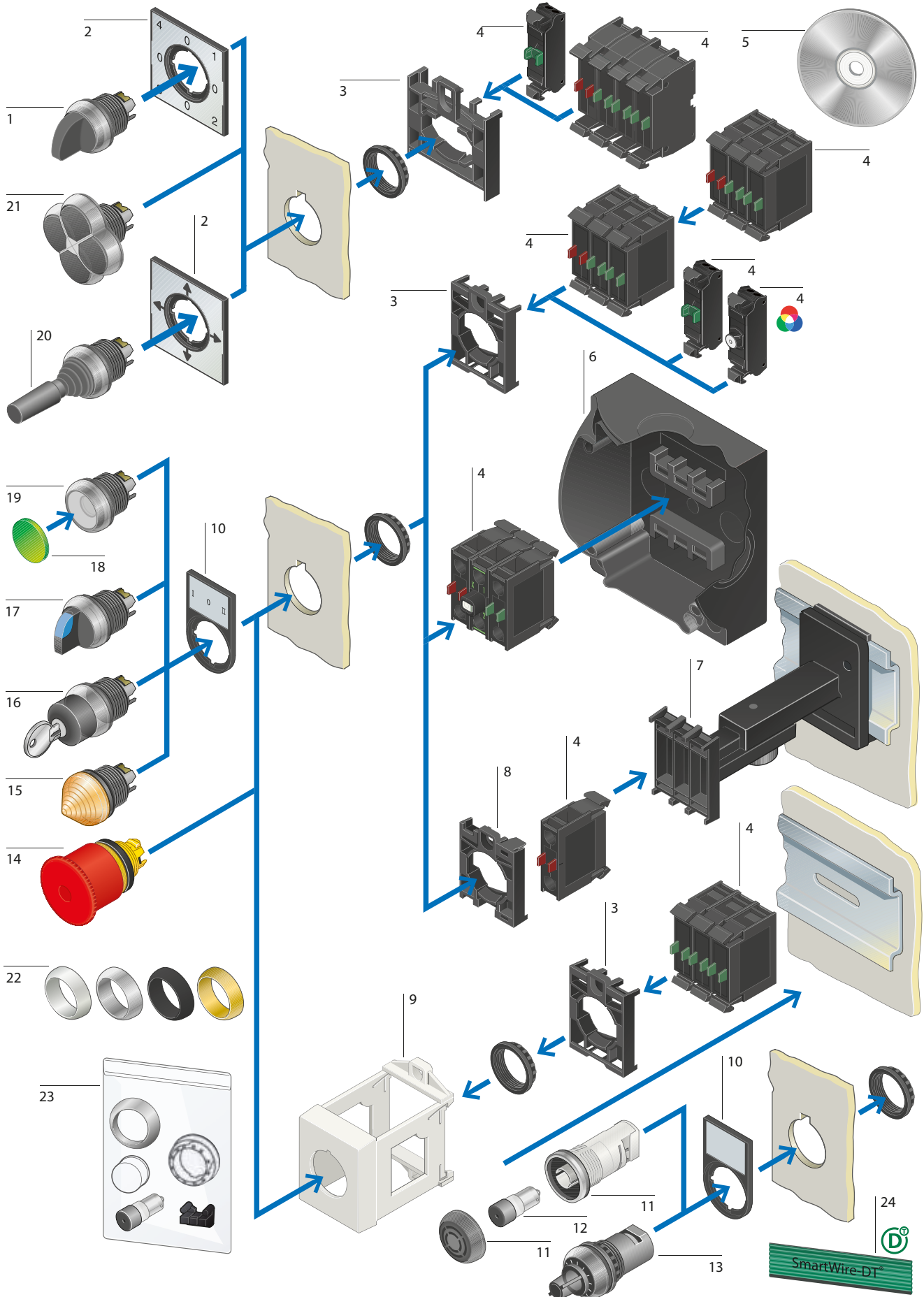









WWW.TM2A.PT info@tm2a.pt



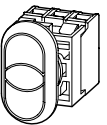

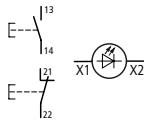

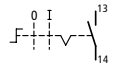
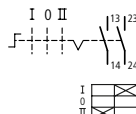
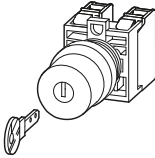
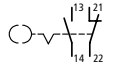







WWW.TM2A.PT info@tm2a.pt

<p>M22 4-way selector switches 1</p> <p>4 positions With rotary head or thumb-grip 0-1-0-2-0-3-0-4 maintained action → Page 28</p> <hr/> <p>Labels with label mounts 2</p> <p>Color: aluminum Labels: with inscription, with custom inscription, blank → Page 32</p> <hr/> <p>Mounting adapters 3</p> <p>For flush mounting For contact and LED elements when using M22-A... For contact elements when using M22-A4 → Page 48</p> <hr/> <p>(Double) contact elements 4</p> <p>N/C and N/O Universal contacts suitable for use with electronic devices Safety function implemented with positive opening as defined in IEC/EN 60947-5-1 Max. 2 levels, each with 3 contact elements → Page 49</p> <hr/> <p>LED elements 4</p> <p>Voltage range: 12 - 30 V AC/DC 85 - 264 V AC → Page 51</p> <hr/> <p>Convenient labeling 5</p> <p>A laser inscription with any text and/ or symbol can be added to all button plates, indicator lights, and add-on legend plates from the RMQ-Silver range of products. Download: www.eaton.eu/config/rmq Keyword: "Pushbutton Configurator → Label Editor function"</p> <hr/> <p>Enclosures 6</p> <p>IP67 surface mounting enclosures with up to 6 mounting locations IP55 surface mounting enclosures with up to 12 mounting locations IP54 flush mounting plates with up to 6 mounting locations IP40 and IP55 shrouds for flush mounting plates → Page 67</p> <hr/> <p>Telescopic clip 7</p> <p>4 positions For adjusting the depth of rear mounting devices in CI and CI-K enclosures and cabinets → Page 69</p>	<p>Centering adapter 8</p> <p>For centering pilot device elements when using a telescopic clip → Page 69</p> <hr/> <p>IVS top-hat rail adapter 9</p> <p>For direct mounting on IEC/EN 60175 DIN-rail → Page 70</p> <hr/> <p>Label mounts 10</p> <p>For insert labels Color: black Insert labels: aluminum color, with inscription or blank, can be engraved → Page 57</p> <hr/> <p>Acoustic device 11</p> <p>IP40 degree of protection without buzzer → Page 34</p> <hr/> <p>Buzzer for acoustic device 12</p> <p>Continuous tone, pulse tone 18 - 30 V DC → Page 34</p> <hr/> <p>Potentiometers 13</p> <p>Resistances of 1 kΩ - 1 MΩ 3 individual connections With screw terminals → Page 34</p> <hr/> <p>Controlled stop/emergency stop buttons 14</p> <p>Tamper-proof as defined in ISO 13850/EN 418 Can be secured with a sealable shroud Additional labels, with inscription or blank → Page 14</p> <hr/> <p>Indicator lights 15</p> <p>Style: flush, conical Colors: white, green, red, yellow, blue → Page 33</p> <hr/> <p>Key-operated buttons 16</p> <p>2 and 3 positions Programmable momentary/ maintained action and key withdraw Suitable for master key systems → Page 29</p> <hr/> <p>Selector switches 17</p> <p>2 and 3 positions With rotary head, thumb-grip Programmable maintained/ momentary action Illuminated selector switches with transparent thumb-grip Colors: white, green, red, yellow, blue → Page 28</p>	<p>Button plates/button lenses 18</p> <p>Laser inscription for pushbuttons and mushroom pushbuttons Button lenses for illuminated pushbutton actuators and indicator lights, flush With standard texts and symbols or with customized inscriptions → Page 60</p> <hr/> <p>Pushbuttons 19</p> <p>Momentary and maintained Flush and extended With and without guard ring Mushroom pushbuttons, double actuator pushbuttons Colors: white, green, red, yellow, blue, black Illuminated pushbutton actuators Colors: white, green, red, yellow, blue → Page 25</p> <hr/> <p>Joysticks 20</p> <p>4 positions → Page 31</p> <hr/> <p>4-way pushbuttons 21</p> <p>4 positions Pushbuttons, momentary → Page 32</p> <hr/> <p>Bezels 22</p> <ul style="list-style-type: none"> • Silver • Black • 24 carat gold can only be ordered with M22-COMBINATION <p>→ Page 69</p> <hr/> <p>Accessories 23</p> <p>→ Page 69</p> <hr/> <p>SmartWire-DT 24</p> <hr/> <p>Product characteristics</p> <ul style="list-style-type: none"> • Clip-fit assembly modular system • Silver, black, or gold bezel • Mounting hole diameter: 22.3 mm • Minimum grid dimension: 30 x 40 mm • Min. degree of protection: IP66 • Up to 6 contacts per mounting location • For switching differing potentials • Approved throughout the world
--	---	---

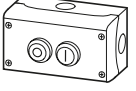
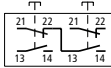
Product selection

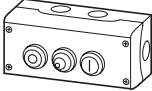
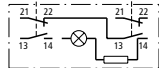
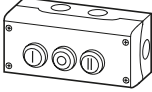



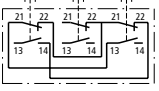









	Button plate	Contact configuration: ⊖ = Safety function implemented with positive opening as defined in IEC/EN 60947-5-1 N/O = Normally open contact N/C = Normally closed contact	Contact sequence	Degree of protection	Silver bezel Part no. Article no.	Std. pack		
Pushbuttons								
	Flush							
		–	1 N/C ⊖		IP67, IP69K	M22-D-R-X0/K01 216510	5 units	
		1 N/O	–		IP67, IP69K	M22-D-G-X1/K10 216512	5 units	
Double actuator pushbutton with LED element, white lens								
	85 - 264 V AC							
	 	1 N/O	1 N/C ⊖		IP66	M22-DDL-GR-X1/X0/K11/230-W 216509	5 units	
Selector switches								
	Black thumb-grip Maintained/momentary action, can be changed with M22-XC-Y configuration adapters → Page 74 Switch positions 0, I, II correspond to the operator's position when viewed from the front. Gold-plated bezel → Page 69							
	2 positions Maintained	–	1 N/O	–		IP66	M22-WRK/K10 216518	5 units
	3 positions Maintained	–	2 N/O	–		IP66	M22-WRK3/K20 216520	5 units
Key-operated button								
	Maintained/momentary action and key withdraw can be changed with M22-XC-... configuration adapters → Page 74 2 positions maintained MS1 lock mechanism, with 1 key							
	–	–	1 N/O	1 N/C ⊖		IP66	M22-WRS/K11 216517	5 units























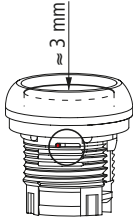
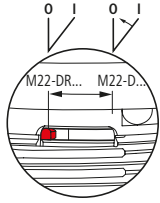

Silver bezel

Number of operators	Contact configuration: ⊖ = Safety function implemented with positive opening as defined in IEC/EN 60947-5-1		Contact sequence	Color of enclosure top	Degree of protection	Part no. Article no.	Std. pack	
Qty.	N/O = Normally open contact	N/C = Normally closed contact		RAL number				
Pushbuttons								
Flush								
	1	1 N/O	1 N/C ⊖		●	RAL 7035 IP67, IP69K M22-D-G-X1/KC11/I 216522	1 unit	
								
	1	1 N/O	1 N/C ⊖		●	RAL 7035 IP67, IP69K M22-D-R-X0/KC11/I 216521		
								
Key-operated button								
	Maintained/momentary action and key withdraw can be changed with M22-XC-... configuration adapters → Page 74							
	With 1 key 2 positions, maintained MS1 lock mechanism							
	1	1 N/O	1 N/C ⊖	●	RAL 7035 IP66 M22-WRS/KC11/I 216526	1 unit		
								
Assembled control station								
Without indicator lights	2	2 N/O	2 N/C ⊖	 	●	RAL 7035 IP67, IP69K M22-I2-M1 216529	1 unit	
								
With white indicator light, LED element 85 - 264 V AC	2	2 N/O	2 N/C ⊖	 	●	RAL 7035 IP67, IP69K M22-I3-M2 216533	1 unit	
								
Assembled control station								
	3	3 N/O	3 N/C ⊖	  	●	RAL 7035 IP67, IP69K M22-I3-M1 216532	1 unit	
								
Customized complete devices								
	To order, use form FO315 → Data sheet in online catalog					M22-COMBINATION 2010741	1 unit	

WWW.TM2A.PT info@tm2a.pt

WWW.TM2A.PT info@tm2a.pt

Style	Button plate	Silver bezel	Black bezel	Std. pack
		Part no. Article no.	Part no. Article no.	
 <p>Double actuator pushbuttons with indicator light, IP66</p> <p>White lens Momentary Gold-plated bezel → Page 69</p>				
Extended pushbuttons and indicator light		M22-DDL-GR 216698	M22S-DDL-GR 216699	5 units
		M22-DDL-GR-X1/X0 216700	M22S-DDL-GR-X1/X0 216701	
		M22-DDL-GR-GB1/GB0 216702	M22S-DDL-GR-GB1/GB0 216703	
		M22-DDL-WS 216704	M22S-DDL-WS 216705	
		M22-DDL-WS-X1/X0 216706	M22S-DDL-WS-X1/X0 216707	
		M22-DDL-WS-GB1/GB0 216708	M22S-DDL-WS-GB1/GB0 216709	
		M22-DDL-S-X7/X7 216710	M22S-DDL-S-X7/X7 216711	
		M22-DDL-S-X226/X26 105227	–	
		M22-DDL-S-X4/X5 218145	M22S-DDL-S-X4/X5 218146	
	With customized Label Editor inscription → Notes	M22-DDL-*.~.* 226770	M22S-DDL-*.~.* 230350	
Flush pushbuttons and indicator light		M22-DDLF-GR-X1/X0 284814	M22S-DDLF-GR-X1/X0 284815	5 units
		M22-DDLF-WS-X1/X0 284816	M22S-DDLF-WS-X1/X0 284817	
	With customized Label Editor inscription → Notes	M22-DDLF-*.~.* 284818	M22S-DDLF-*.~.* 284819	
Pushbutton I and indicator light flush, pushbutton O extended		M22-DDLM-GR-X1/X0 284830	M22S-DDLM-GR-X1/X0 284831	5 units
		M22-DDLM-WS-X1/X0 284832	M22S-DDLM-WS-X1/X0 284833	
	With customized Label Editor inscription → Notes	M22-DDLM-*.~.* 107062		
Notes		1st wildcard (*)	= Button plate color:	B = Blue, G = Green, R = Red, S = Black B/S = Blue top/black base G/R = Green top/red base G/S = Green top/black base W/S = White top/black base
		2nd and 3rd wildcards (*)	= Filename assigned by Label Editor (enter twice) Additional color combinations available upon request → Engineering, Page 74	

Button plate	Silver bezel		Std. pack	Black bezel		Notes	
	Part no. Article no.			Part no. Article no.	Std. pack		
IP67, IP69K pushbuttons							
Gold-plated bezel → Page 69							
Flush, momentary 		M22-D-S 216590	10 units	M22S-D-S 216591	10 units	–	
		M22-D-W 216592		M22S-D-W 216593			
		M22-D-R 216594		M22S-D-R 216595			
		M22-D-G 216596		M22S-D-G 216597			
		M22-D-Y 216598		M22S-D-Y 216599			
		M22-D-B 216600		M22S-D-B 216601			
		M22-D-GR 132671		M22S-D-GR 132672			
	–	M22-D-X 216602		M22S-D-X 216604			
	–	M22-D-X-GVP 216603	50 units				
		M22-D-R-X0 216605	10 units	M22S-D-R-X0 216606	10 units		
		M22-D-G-X1 216607		M22S-D-G-X1 216608			
		M22-D-S-X0 216609		M22S-D-S-X0 216610			
		M22-D-W-X1 216611		M22S-D-W-X1 216612			
	Flush, maintained 		M22-DR-S 216613	5 units	M22S-DR-S 216614	5 units	Programmable maintained/ momentary pushbutton action  
			M22-DR-W 216615		M22S-DR-W 216616		
		M22-DR-R 216617		M22S-DR-R 216618			
		M22-DR-G 216619		M22S-DR-G 216620			
		M22-DR-Y 216621		M22S-DR-Y 216622			
		M22-DR-B 216623		M22S-DR-B 216624			
–		M22-DR-X 216625		M22S-DR-X 216627			
–		M22-DR-X-GVP 216626	50 units				
		M22-DR-R-X0 216628	5 units	M22S-DR-R-X0 216629	5 units		
		M22-DR-G-X1 216630		M22S-DR-G-X1 216631			
		M22-DR-S-X0 216632		M22S-DR-S-X0 216633			
		M22-DR-W-X1 216634		M22S-DR-W-X1 216635			

Button plate	Silver bezel		Black bezel		Notes
	Part no. Article no.	Std. pack	Part no. Article no.	Std. pack	

IP67, IP69K pushbuttons

Gold-plated bezel → Page 69

Extended, momentary



	M22-DH-S 216636	5 units	M22S-DH-S 216637	5 units	–
	M22-DH-W 216638		M22S-DH-W 216639		
	M22-DH-G 216643		M22S-DH-G 216645		
	M22-DH-R 216641		M22S-DH-R 216642		
	M22-DH-Y 216646		M22S-DH-Y 216647		
	M22-DH-B 216649		M22S-DH-B 216650		
	M22-DH-R-X0 216655		M22S-DH-R-X0 216656		
	M22-DH-G-X1 216657		M22S-DH-G-X1 216658		
	M22-DH-S-X0 216659		M22S-DH-S-X0 216660		
	M22-DH-W-X1 216661		M22S-DH-W-X1 216662		

Extended, maintained



	M22-DRH-S 216663	5 units	M22S-DRH-S 216664	5 units	Programmable maintained/ momentary pushbutton action
	M22-DRH-W 216665		M22S-DRH-W 216666		
	M22-DRH-R 216667		M22S-DRH-R 216668		
	M22-DRH-G 216669		M22S-DRH-G 216670		
	M22-DRH-Y 216671		M22S-DRH-Y 216672		
	M22-DRH-B 216673		M22S-DRH-B 216674		
	M22-DRH-R-X0 216675		M22S-DRH-R-X0 216676		
	M22-DRH-G-X1 216677		M22S-DRH-G-X1 216678		
	M22-DRH-S-X0 216679		M22S-DRH-S-X0 216680		
	M22-DRH-W-X1 216681		M22S-DRH-W-X1 216682		

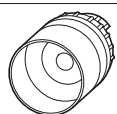
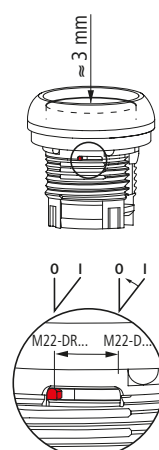

Pushbuttons with guard ring, momentary, IP66, IP69K

Gold-plated bezel → Page 69

–	M22-DG-X 220921	5 units	–	–
---	---------------------------	---------	---	---

Button plate	Button color	Silver bezel Part no. Article no.	Std. pack	Black bezel Part no. Article no.	Std. pack	Notes
--------------	--------------	---	-----------	--	-----------	-------

Mushroom pushbuttons, IP67, IP69K

Gold-plated bezel → Page 69

Momentary

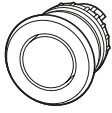

●	●	M22-DP-S 216712	5 units	M22S-DP-S 216713	5 units	–
●	●	M22-DP-R 216714		M22S-DP-R 216715		
●	●	M22-DP-G 216716		M22S-DP-G 216717		
●	●	M22-DP-Y 216718		M22S-DP-Y 216719		
⊙	●	M22-DP-R-X0 216720		M22S-DP-R-X0 216721		
⊖	●	M22-DP-G-X1 216722		M22S-DP-G-X1 216723		
⊙	●	M22-DP-S-X0 216724		M22S-DP-S-X0 216725		
⊖	●	M22-DP-W-X1 216726		M22S-DP-W-X1 216727		
–	●	M22-DP-S-X 216728		M22S-DP-S-X 216730		
–	●	M22-DP-R-X 216731		M22S-DP-R-X 216733		
–	●	M22-DP-G-X 216734		M22S-DP-G-X 216736		
–	●	M22-DP-Y-X 216737		M22S-DP-Y-X 216739		

Maintained



●	●	M22-DRP-S 216743	5 units	M22S-DRP-S 216744	5 units	Programmable maintained/ momentary pushbutton action
●	●	M22-DRP-R 216745		M22S-DRP-R 216746		
●	●	M22-DRP-G 216747		M22S-DRP-G 216748		
●	●	M22-DRP-Y 216749		M22S-DRP-Y 216750		
⊙	●	M22-DRP-R-X0 216751		M22S-DRP-R-X0 216752		
⊖	●	M22-DRP-G-X1 216753		M22S-DRP-G-X1 216754		
⊙	●	M22-DRP-S-X0 216755		M22S-DRP-S-X0 216756		
⊖	●	M22-DRP-W-X1 216757		M22S-DRP-W-X1 216758		
–	●	M22-DRP-S-X 216759		M22S-DRP-S-X 216761		
–	●	M22-DRP-R-X 216762		M22S-DRP-R-X 216764		
–	●	M22-DRP-G-X 216765		M22S-DRP-G-X 216767		
–	●	M22-DRP-Y-X 216768		M22S-DRP-Y-X 216770		

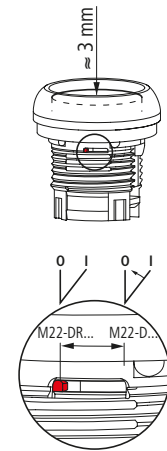

Action:	Button plate	Inscription	Function	Silver bezel Part no. Article no.	Std. pack	Black bezel Part no. Article no.	Std. pack
▷ = Momentary (MO)							
┘ = Maintained (MA)							

Selector switches, IP66

Gold-plated bezel → Page 69

Maintained/momentary action can be changed with configuration kit → Page 30

2 positions

With rotary head



▷ 40°		–	–	M22-W 216853	5 units	M22S-W 216854	5 units
┘ 60°		–	–	M22-WR 216855		M22S-WR 216856	
┘ 60°		–	–	M22-WR-X92 216857		M22S-WR-X92 216858	
┘ 60°		AUTO MANUAL	–	M22-WR-X91 216859		M22S-WR-X91 216860	
┘ 60°		* = With customized Label Editor inscription → Page 74	–	M22-WR-* 226836		M22S-WR-* 226837	

With thumb-grip



▷ 40°	–	–	–	M22-WK 216865	5 units	M22S-WK 216866	5 units
┘ 60°	–	–	–	M22-WRK 216867	10 units	M22S-WRK 216869	10 units
┘ 60°	–	–	–	M22-WRK-GVP 216868	50 units		50 units

With thumb-grip, V configuration



┘ 60°	–	–	–	M22-WKV 216874	5 units	M22S-WKV 216875	5 units
-------	---	---	---	--------------------------	---------	---------------------------	---------

3 positions

With plunger bridge → Page 74

With rotary head



40° ↙ 40°		–	–	M22-W3 216861	5 units	M22S-W3 216862	5 units
60° ↙ 60°		–	–	M22-WR3 216863		M22S-WR3 216864	
60° ↙ 60°		AUTO 0 MAN.	–	M22-WR3-X94 226838		M22S-WR3-X94 226839	
60° ↙ 60°		* = With customized Label Editor inscription → Page 74	–	M22-WR3-* 226840		M22S-WR3-* 226841	

With thumb-grip



40° ↙ 40°	–	–	–	M22-WK3 216870	5 units	M22S-WK3 216871	5 units
60° ↙ 60°	–	–	–	M22-WRK3 216872		M22S-WRK3 216873	
–	–	–	–	M22-WRK3-^{*1} 217436		M22S-WRK3-^{*1} 217437	

4 positions

Not compatible with configuration adapters

Use mounting adapter M22-A4 → Page 48, Legend plates → Page 32

With rotary head



45°		–		M22-WR4 279419	5 units	M22S-WR4 279430	5 units
-----	--	---	--	--------------------------	---------	---------------------------	---------

With thumb-grip



45°		–		M22-WRK4 279431	5 units	M22S-WRK4 279432	5 units
-----	--	---	--	---------------------------	---------	----------------------------	---------

Notes

¹⁾ * can be replaced with a 1 or 2:

* = 1: for 60° ↙ 40°

* = 2: for 40° ↙ 60°

Action:	Key withdrawable at position	Part no. Article no.	Std. pack	Silver bezel Part no. Article no.	Std. pack	Black bezel Part no. Article no.	Std. pack
↳ = Momentary (MO)							
└ = Maintained (MA)							



Key-operated buttons for individual lock mechanisms, IP66

Gold-plated bezel → Page 69
 Not suitable for master key systems
 With 1 key
 Maintained/momentary action and key withdraw can be changed with configuration adapters → Page 30

2 positions

MS1 lock mechanism	↳ 40°	–	0	–	M22-WS 216881	1 unit	M22S-WS 216882	1 unit
	└ 60°	–	0	I	M22-WRS 216887	5 units	M22S-WRS 216889	5 units
	↳ 60°	–	0	I	M22-WRS-GVP 216888	25 units		
	└ 60°	–	0	–	M22-WRS-A1 229092	5 units	M22S-WRS-A1 229093	5 units
MS2 – MS20 lock mechanisms (enter lock mechanism number in the part no.)	↳ 40°	–	0	–	M22-WS-MS*¹⁾ 216883	1 unit	M22S-WS-MS*¹⁾ 216884	1 unit
	└ 60°	–	0	I	M22-WRS-MS*¹⁾ 216890	1 unit	M22S-WRS-MS*¹⁾ 216891	1 unit
	↳ 50°	–	0	–	M22-WRS-MS*-A1¹⁾ 217440	5 units	M22S-WRS-MS*-A1¹⁾ 217441	5 units

3 positions

With plunger bridge → Engineering, Page 74

MS1 lock mechanism	40° ↘ 40°	–	0	–	M22-WS3 216894	1 unit	M22S-WS3 216895	1 unit
	60° ↓ 60°	I	0	II	M22-WRS3 216900	5 units	M22S-WRS3 216901	5 units
	60° ↓ 60°	I	0	II	M22-WRS3-GVP 216902	25 units		
	↓	Selectable ²⁾	–	–	M22-WRS3-A*¹⁾⁴⁾ 229094	5 units	M22S-WRS3-A*¹⁾⁴⁾ 229095	5 units
MS2 – MS20 lock mechanisms (enter lock mechanism number in the part no.)	Selectable	Selectable ²⁾	–	–	M22-WRS3-MS*-A*¹⁾²⁾ 217442	5 units	M22S-WRS3-MS*-A*¹⁾²⁾ 217443	5 units
	40° ↘ 40°	–	0	–	M22-WS3-MS*¹⁾ 216896	1 unit	M22S-WS3-MS*¹⁾ 216897	1 unit
	60° ↓ 60°	I	0	II	M22-WRS3-MS*¹⁾ 216903	1 unit	M22S-WRS3-MS*¹⁾ 216904	1 unit

2 or 3 positions

MS2 – MS20 lock mechanisms (enter lock mechanism number in the part no.)	Selectable	Selectable	–	–	M22-WRS*-MS*-*¹⁾³⁾ 262521	1 unit		
---	------------	------------	---	---	--	--------	--	--

Individual keys

Spare key for AUTO - OFF/RESET - MANUAL key-operated switches

For MS1 lock mechanism	M22-ES-MS1 216416	5 units
For MS2 – MS20 lock mechanism	M22-ES-MS* 216417	1 unit

Notes

- ¹⁾ Delivery: 4 weeks after the order is received by the factory
- ²⁾ Example: M22(S)-WRS3-MS*-A*
 MS*: * = MS2 - MS20 (individual lock mechanism number)
 A*: * = 1, action: ↓, withdrawable in switch position 0
 * = 2, action: ↓, withdrawable in contactor state I, 0
 * = 3, action: ↓, withdrawable in contactor state 0, II
 * = 4, action: ↓, withdrawable in switch positions I, 0
 * = 5, action: ↓, withdrawable in switch position 0
 * = 6, action: ↓, withdrawable in switch positions 0, II
 * = 7, action: ↓, withdrawable in switch position 0
 * = 10, action: ↓, withdrawable in switch positions I, II
- ³⁾ Example: M22(S)-WRS*-MS*-*
 WRS*: * = 2 or 3 positions (action and key withdraw as M22-WRS or M22-WRS3)
 MS*: * = * = MS2 - MS20 (individual lock mechanism number)
 -*: * = Customized inscription with Label Editor; replace * with the automatically assigned filename (→ Engineering, Page 74) or "blank" if no inscription is required
- ⁴⁾ Version A10 cannot be selected.

Action:	Key withdrawable at position	Silver bezel Part no. Article no.	Std. pack	Black bezel Part no. Article no.	Std. pack
---------	------------------------------	---	-----------	--	-----------

- ↳ = Momentary (MO)
- └ = Maintained (MA)

Key-operated buttons for master key systems, IP66

Gold-plated bezel → Page 69
With 2 keys

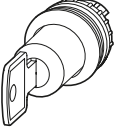
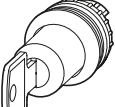
2 positions					
	↳ 40°	0	M22-WS-SA(*)-* 216885	5 units	M22S-WS-SA(*)-* 216886
	└ 60°	0	M22-WRS-SA(*)-* 216892		M22S-WRS-SA(*)-* 216893
	↳ 60°	0 I	M22-WRS-SA(*)-*-A8 285537		M22S-WRS-SA(*)-*-A8 285538
3 positions	60° ↓ 60°	I 0 II	M22-WRS3-SA(*)-*-A9 285539		M22S-WRS3-SA(*)-*-A9 285581
	40° ↙ 40°	0	M22-WS3-SA(*)-* 216898		M22S-WS3-SA(*)-* 216899
	60° ↓ 60°	0	M22-WRS3-SA(*)-* 216905		M22S-WRS3-SA(*)-* 216906

Individual keys for master key systems



	0	M22-ES-SA(*)-* 217444	10 units	
---	---	---------------------------------	----------	--

Notes Master key systems: Delivery will take 4 to 6 weeks after the order is received at the factory
To order, use form MZ047002ZU (formerly F0276) → Data sheet in online catalog

Action	Part no. Article no.	Std. pack
--------	-------------------------	-----------

Configuration kit

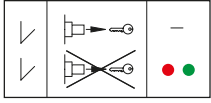
Not for key-operated buttons for master key systems

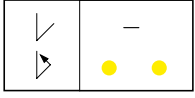
For converting the key withdraw → Page 74			50°	M22-XC-R 216406	10 units
For converting between maintained and momentary action → Page 74			40°	M22-XC-Y 216407	10 units

Text	Action:	For use with	Silver bezel Part no. Article no.	Std. pack	Black bezel Part no. Article no.	Std. pack
	↳ = Momentary (MO)					
	└ = Maintained (MA)					



Joysticks, IP66

Gold-plated bezel → Page 69, use M22-A4 adapter
One operating point per operating direction

2 positions	↔	–	M22-WJ2H 289195	1 unit	M22S-WJ2H 289197	1 unit
	↔	–	M22-WJS2H¹⁾ 178570			
	—	–	M22-WR2H 289199		M22S-WR2H 289241	
	—	–	M22-WRJS2H¹⁾ 178574			
	└↔	–	M22-WJ2V 289196		M22S-WJ2V 289198	
	└↔	–	M22-WJS2V¹⁾ 178571			
	└—	–	M22-WR2V 289240		M22S-WR2V 289242	
	└—	–	M22-WRJS2V¹⁾ 178575			
4 positions	+	–	M22-WR4 279415	5 units	M22S-WR4 279416	5 units
	+	–	M22-WRJS4¹⁾ 178566			
	↔↕	–	M22-WJ4 279417		M22S-WJ4 279418	
	↔↕	–	M22-WJS4¹⁾ 178568			

Joysticks with two operating points per operating direction

These joysticks are combined with M22-K10 normal N/O and M22-K10P early-make contacts.



2 positions	↔↔	–	M22-WJ2H-2P 111508	1 unit		
	↔↔	–	M22-WJS2H-2P¹⁾ 178565			
	└↔	–	M22-WJ2V-2P 111507			
	└↔	–	M22-WJS2V-2P¹⁾ 178564			
4 positions	↔↕↔↕	–	M22-WJ4-2P 110836			
	↔↕↔↕	–	M22-WJS4-2P¹⁾ 178563			

Notes ¹⁾ With metal shaft

-*-*: * B = Blue, G = Green, R = Red, B = Black, W = White, Y = Yellow
Specify colors clockwise, starting at 12 o'clock



-*-*: * = Filename assigned by Label Editor
→ Engineering, Page 74

1.4

RMQ-Titan pilot devices

M22 – 4-way pushbuttons, legend plates

Moeller series

1

Text	Action:	For use with	Silver bezel Part no. Article no.	Std. pack	Black bezel Part no. Article no.	Std. pack
	↳ = Momentary (MO)					
	└ = Maintained (MA)					

Pushbuttons, IP66, 4-way

Opposing buttons not mechanically interlocked



No inscription, black pushbuttons	↕	–	M22-D4-S 279411	5 units	M22S-D4-S 279412	5 units
Custom inscription and pushbutton color → Notes	↕	–	M22-D4-**-* 279413		M22S-D4-**-* 279414	

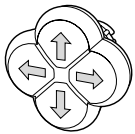

White arrows, black pushbuttons	↕	–	M22-D4-S-X7 286336		M22S-D4-S-X7 286337	
---------------------------------	---	---	------------------------------	--	-------------------------------	--

Opposing pushbuttons mechanically interlocked



White arrows, black pushbuttons	↕	–	M22-D14-S-X7 286338		M22S-D14-S-X7 286339	
Customized pushbutton inscription and color, → Notes	↕	–	M22-D14-**-* 286340		M22S-D14-**-* 286341	

Notes

¹⁾ With metal shaft

-*-*: * B = Blue, G = Green, R = Red, B = Black, W = White, Y = Yellow
Specify colors clockwise, starting at 12 o'clock



-*-*: * = Filename assigned by Label Editor
→ Engineering, Page 74

Inscription	For use with	Silver bezel Part no. Article no.	Std. pack
-------------	--------------	---	-----------

Legend plates



No inscription	Joysticks 4-way selector switches	M22-XCK 279433	10 units
----------------	--------------------------------------	--------------------------	----------



4 direction arrows	Joysticks 4-way selector switches	M22-XCK1 279434	
--------------------	--------------------------------------	---------------------------	--

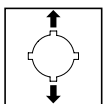

2 direction arrows, can be turned 90°	2-position joysticks	M22-XCK3 290260	
--	----------------------	---------------------------	--



0-1-0-2-0-3-0-4	4-way selector switches	M22-XCK2 279435	
-----------------	-------------------------	---------------------------	--



With customized Label Editor inscription → Engineering, Page 74	Joysticks 4-way selector switches	M22-XCK-* 279436	
--	--------------------------------------	----------------------------	--

Notes

-*-*: * B = Blue, G = Green, R = Red, B = Black, W = White, Y = Yellow
Specify colors clockwise, starting at 12 o'clock



-*-*: * = File name generated by Label editor
→ Engineering, Page 74

Contact sequence	Resistance R kΩ	Silver bezel	Std. pack	Black bezel	Std. pack
		Part no. Article no.		Part no. Article no.	

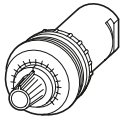

Potentiometers, IP66

Gold-plated bezel → Page 69
 3 separate screw connections, $P_{max} = 0.5 \text{ W}$
 Accuracy of resistance value: $\pm 10\%$ (linear)
 M22...RH with large knob



1	M22-R1K 229489	1 unit	M22S-R1K 232231	1 unit
2.2	M22-R2K2 171157			
4.7	M22-R4K7 229490		M22S-R4K7 232232	
10	M22-R10K 229491		M22S-R10K 232233	
47	M22-R47K 229492		M22S-R47K 232234	
100	M22-R100K 229493		M22S-R100K 232235	
470	M22-R470K 229494		M22S-R470K 232236	
Selectable → Notes ¹⁾	M22-R*.* 263371		M22S-R*.* 263372	
Selectable → Notes ¹⁾	M22-R*.*-RH 288863			

Notes

¹⁾ The following information must be added to the part no. when ordering:

- 1st asterisk Δ Resistance
- 2nd asterisk Δ Standard scale/inscription
- * - * : * = Available resistance values:
 - 1K = 1 kΩ
 - 2K2 = 2.2 kΩ
 - 4K7 = 4.7 kΩ
 - 10K = 10 kΩ
 - 22K = 22 kΩ
 - 47K = 47 kΩ
 - 100K = 100 kΩ
 - 470K = 470 kΩ
 - 1M = 1 MΩ
- * - * : * = Standard scale/inscription: X1000
 No scale/inscription: "blank"

Part no.
Article no.

Std. pack

Compact acoustic device, IP40

Black front, without buzzer, with BA 9s lamp socket

M22-AMC
229015

1 unit

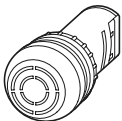

Buzzer for acoustic device

For BA 9s socket
 83 dB/10 cm,
 18 - 30 mA,
 Positive pin at X1,
 f = 2300 Hz

Continuous tone, 18 - 30 V DC

M22-XAM
229025

1 unit

Pulse tone, 24 V DC (+10%/-15%)

































M22-XAMP
229028

1 unit









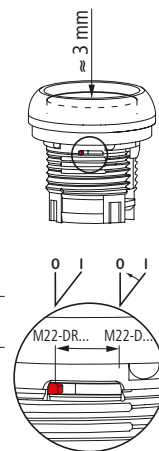



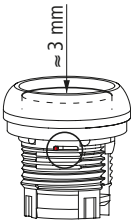
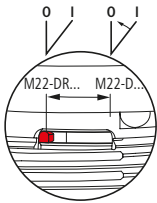

WWW.TM2A.PT info@tm2a.pt

WWW.TM2A.PT info@tm2a.pt

Color	Silver bezel Part no. Article no.	Black bezel Part no. Article no.	Std. pack	Notes		
Illuminated pushbutton actuators, IP67, IP69K						
Gold-plated bezel → Page 69						
Flush Momentary 		M22-DL-W 216922	M22S-DL-W 216924	10 units	–	
		M22-DL-R 216925	M22S-DL-R 216926			
		M22-DL-G 216927	M22S-DL-G 216928			
		M22-DL-Y 216929	M22S-DL-Y 216930			
		M22-DL-B 216931	M22S-DL-B 216932			
		M22-DL-A 167429	M22S-DL-A 167430			
	–	M22-DL-X 216933	M22S-DL-X 216935			
	–	M22-DL-X-GVP 216934		50 units		
		M22-DL-R-X0 216936	M22S-DL-R-X0 216937	10 units		
		M22-DL-G-X1 216938	M22S-DL-G-X1 216939			
		M22-DL-W-X0 216940	M22S-DL-W-X0 216941			
		M22-DL-W-X1 216942	M22S-DL-W-X1 216943			
	Flush Maintained 		M22-DRL-W 216944	M22S-DRL-W 216945	5 units	Programmable maintained/ momentary pushbutton action
			M22-DRL-R 216946	M22S-DRL-R 216947		
		M22-DRL-G 216948	M22S-DRL-G 216949			
		M22-DRL-Y 216950	M22S-DRL-Y 216951			
		M22-DRL-B 216952	M22S-DRL-B 216953			
		M22-DRL-A 167431				
–		M22-DRL-X 216954	M22S-DRL-X 216956			
–		M22-DRL-X-GVP 216955		50 units		
		M22-DRL-R-X0 216957	M22S-DRL-R-X0 216958	5 units		
		M22-DRL-G-X1 216959	M22S-DRL-G-X1 216960			
		M22-DRL-W-X0 216961	M22S-DRL-W-X0 216962			
		M22-DRL-W-X1 216963	M22S-DRL-W-X1 216964			
Extended Momentary 			M22-DLH-W 216965	M22S-DLH-W 216966	5 units	
			M22-DLH-R 216967	M22S-DLH-R 216968		
		M22-DLH-G 216969	M22S-DLH-G 216970			
		M22-DLH-Y 216971	M22S-DLH-Y 216972			
		M22-DLH-B 216973	M22S-DLH-B 216974			
		M22-DLH-A 167433	M22S-DLH-A 167434			
		M22-DLH-R-X0 216975	M22S-DLH-R-X0 216976			
		M22-DLH-G-X1 216977	M22S-DLH-G-X1 216978			
		M22-DLH-W-X0 216979	M22S-DLH-W-X0 216980			
		M22-DLH-W-X1 216981	M22S-DLH-W-X1 216982			



Color	Silver bezel Part no. Article no.	Black bezel Part no. Article no.	Std. pack	Notes	
Illuminated pushbutton actuators, IP67, IP69K					
Gold-plated bezel → Page 69					
Extended Maintained 		M22-DRLH-W 216788	M22S-DRLH-W 216791	5 units	Programmable maintained/ momentary pushbutton action  
		M22-DRLH-R 216789	M22S-DRLH-R 216792		
		M22-DRLH-G 216796	M22S-DRLH-G 216798		
		M22-DRLH-Y 216799	M22S-DRLH-Y 216801		
		M22-DRLH-B 216802	M22S-DRLH-B 216803		
		M22-DRLH-A 167435			
		M22-DRLH-R-X0 216804	M22S-DRLH-R-X0 216808		
		M22-DRLH-G-X1 216805	M22S-DRLH-G-X1 216809		
		M22-DRLH-W-X0 216806	M22S-DRLH-W-X0 216810		
		M22-DRLH-W-X1 216807	M22S-DRLH-W-X1 216811		
With guard ring Momentary 	-	M22-DGL-X 230961	5 units		

Action:	Color	Silver bezel Part no. Article no.	Black bezel Part no. Article no.	Std. pack
▷ = Momentary (MO)				
∨ = Maintained (MA)				

Illuminated selector switches, thumb-grip, IP66

Gold-plated bezel → Page 69
 Maintained/momentary action can be changed with M22-XC-Y → Engineering, Page 74

2 positions

Momentary						
	▷ 40°	○	White	M22-WLK-W 216812	M22S-WLK-W 216813	5 units
	▷ 40°	●	Red	M22-WLK-R 216814	M22S-WLK-R 216815	
	▷ 40°	●	Green	M22-WLK-G 216816	M22S-WLK-G 216817	
	▷ 40°	●	Yellow	M22-WLK-Y 216818	M22S-WLK-Y 216819	
	▷ 40°	●	Blue	M22-WLK-B 216820	M22S-WLK-B 216821	

Maintained						
	∨ 60°	○	White	M22-WRLK-W 216823	M22S-WRLK-W 216824	5 units
	∨ 60°	●	Red	M22-WRLK-R 216825	M22S-WRLK-R 216826	
	∨ 60°	●	Green	M22-WRLK-G 216827	M22S-WRLK-G 216828	
	∨ 60°	●	Yellow	M22-WRLK-Y 216829	M22S-WRLK-Y 216830	
	∨ 60°	●	Blue	M22-WRLK-B 216831	M22S-WRLK-B 216832	

3 positions

Momentary						
	40° ∨ 40°	○	White	M22-WLK3-W 216833	M22S-WLK3-W 216834	5 units
	40° ∨ 40°	●	Red	M22-WLK3-R 216835	M22S-WLK3-R 216836	
	40° ∨ 40°	●	Green	M22-WLK3-G 216837	M22S-WLK3-G 216838	
	40° ∨ 40°	●	Yellow	M22-WLK3-Y 216839	M22S-WLK3-Y 216840	
	40° ∨ 40°	●	Blue	M22-WLK3-B 216841	M22S-WLK3-B 216842	

Maintained						
	60° ∨ 60°	○	White	M22-WRLK3-W 216843	M22S-WRLK3-W 216844	5 units
	60° ∨ 60°	●	Red	M22-WRLK3-R 216845	M22S-WRLK3-R 216846	
	60° ∨ 60°	●	Green	M22-WRLK3-G 216847	M22S-WRLK3-G 216848	
	60° ∨ 60°	●	Yellow	M22-WRLK3-Y 216849	M22S-WRLK3-Y 216850	
	60° ∨ 60°	●	Blue	M22-WRLK3-B 216851	M22S-WRLK3-B 216852	
Selectable	Selectable → Notes			M22-WRLK3-*/* 217438	M22S-WRLK3-*/* 217439	

V configuration

	∨ 60°	○	White	M22-WLKV-W 284393	M22S-WLKV-W 284398	5 units
	∨ 60°	●	Red	M22-WLKV-R 284394	M22S-WLKV-R 284399	
	∨ 60°	●	Green	M22-WLKV-G 284395	M22S-WLKV-G 284540	
	∨ 60°	●	Yellow	M22-WLKV-Y 284396	M22S-WLKV-Y 284543	
	∨ 60°	●	Blue	M22-WLKV-B 284397	M22S-WLKV-B 284544	

Notes
 Example: M22-WRLK3-*/*
 /: * = 1 for ∨ or 2 for ∨∨
 /: * = Color

1.5

RMQ-Titan pilot devices

M30 – Flat Front – System overview

Moeller series

1

System overview

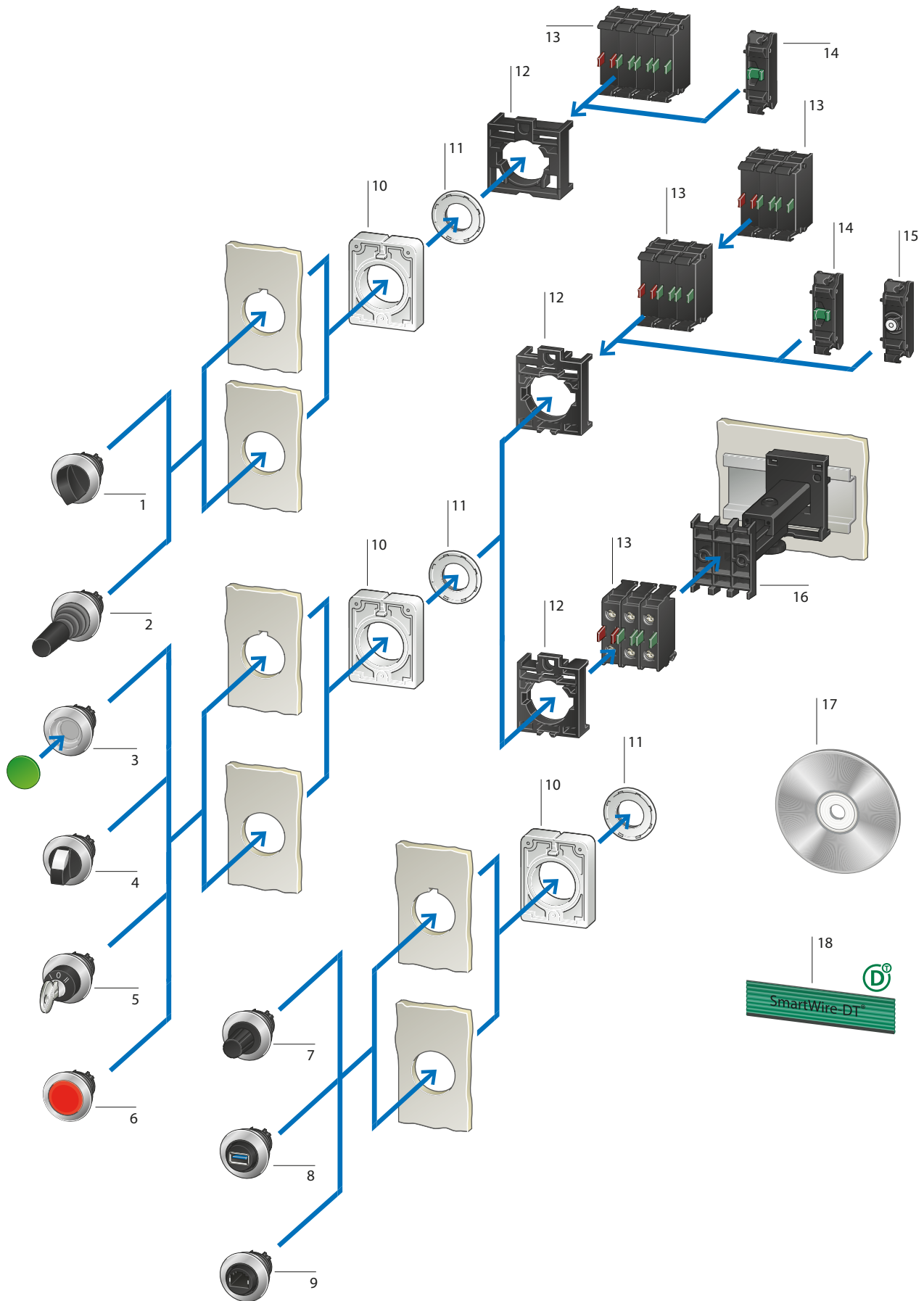

WWW.TM2A.PT info@tm2a.pt

WWW.TM2A.PT info@tm2a.pt





























M30 4-way selector switches	1
4 positions	
With rotary head or thumb-grip	
0-1-0-2-0-3-0-4 maintained action	
→ Page 41	
M30 joysticks	2
2 or 4 positions	
→ Page 44	
M30 pushbuttons	3
Momentary and maintained	
Flush	
Colors: white, green, red, yellow, blue, black	
Illuminated pushbutton actuators	
Colors: white, green, red, yellow, blue, orange	
→ Page 40	
M30 selector switches	4
2 and 3 positions	
With rotary head, thumb-grip	
Programmable maintained/momentary action	
Illuminated selector switches with transparent thumb-grip	
Colors: white, green, red, yellow, blue	
→ Page 41	
M30 key-operated buttons	5
For individual lock mechanisms	
2 or 3 positions	
Programmable momentary/maintained action and key withdraw	
Suitable for master key systems	
→ Page 42	
M30 indicator lights	6
Colors: white, green, red, yellow, blue, orange	
→ Page 44	
SmartWire-DT encoders, M30 potentiometers	7
Resistances of 1 kΩ - 1 MΩ	
3 individual connections	
→ Page 47	

M30 panel mount connectors	8
USB 3.0	
→ Page 71	
M30 panel mount connectors	9
RJ45	
→ Page 71	
RMQ-AFX	10
Anti-rotation tab	
Included with the equipment supplied with M30 front elements	
Threaded rings	11
→ Page 70	
Mounting adapters	12
For flush mounting	
For contact and LED elements	
→ Page 48	
Contact elements	13
N/C and N/O	
Universal contacts suitable for use with electronic devices	
Safety function implemented with positive opening as defined in IEC/EN 60947-5-1	
Max. 2 levels, each with 3 contact elements	
→ Page 48	
Flat Rear contact elements	14
Cage Clamp with push-in terminals	
→ Page 53	
Flat Rear LED elements	15
Cage Clamp with push-in terminals	
→ Page 53	

Telescopic clip	16
For adjusting the depth of rear mounting devices in CI and CI-K enclosures and cabinets	
→ Page 69	
Convenient labeling	17
A laser inscription with any text and/or symbol can be added to all button plates, indicator lights, and add-on legend plates from the RMQ-Silver range of products.	
Download: www.eaton.eu/config/rmq	
Keyword: "Pushbutton Configurator → Label Editor function"	
SmartWire-DT	18
Product characteristics	
<ul style="list-style-type: none"> • Clip-fit assembly modular system • Metal bezel, flush • Mounting hole diameter: 30.5 mm • Minimum grid dimension: 40 x 50 mm • Min. degree of protection: IP66 • Up to 6 contacts per mounting location • For switching differing potentials • Approved throughout the world 	

1

Product selection

	Button plate	Part no. Article no.	Std. pack
Pushbuttons			
IP67, IP69K Metal bezel Front dimensions: 36 mm diameter Flush			
Momentary 		M30C-FD-S 182959	1 unit
		M30C-FD-W 182960	
		M30C-FD-R 182918	
		M30C-FD-G 182919	
		M30C-FD-Y 182920	
		M30C-FD-B 182921	
		M30C-FD-GR 182923	
		M30C-FD-S-X0 182961	
		M30C-FD-W-X1 182962	
		M30C-FD-W-X11 182963	
		M30C-FD-R-X0 182939	
		M30C-FD-G-X1 182956	
		M30C-FD-B-X217 182967	
		M30C-FD-GR-X66 182964	
Momentary 	Without button plate	M30C-FD-X 182922	1 unit
Maintained¹⁾ 		M30C-FDR-S 182942	1 unit
		M30C-FDR-W 182943	
		M30C-FDR-R 182944	
		M30C-FDR-G 182945	
		M30C-FDR-Y 182946	
		M30C-FDR-B 182947	
		M30C-FDR-S-X0 182937	
		M30C-FDR-W-X1 182938	
		M30C-FDR-R-X0 182936	
		M30C-FDR-G-X1 182931	
Maintained¹⁾ 	Without button plate	M30C-FDR-X 182948	1 unit

Notes







¹⁾ Maintained/momentary action can be changed on device

Action:	Button plate	Part no.	Std. pack	Ordering notes
↳ = Momentary (MO)		Article no.		
└ = Maintained (MA)				







Selector switches

IP66
 Metal bezel
 Front dimensions: 36 mm diameter
 Maintained/momentary action can be changed with M22-XC-Y configuration adapters







2 positions

With rotary head 	↳ 40°		M30C-FW 187087	1 unit	
	└ 60°		M30C-FWR 187088		
	└ 60°	AUTO HAND 	M30C-FWR-X91 187113		
	└ 60°		M30C-FWR-X92 187114		
	└ 60°	Customized inscription available	M30C-FWR-* 187105		* = With customized Label Editor inscription → Page 74
With thumb-grip 	↳ 40°		M30C-FWK 187103	1 unit	
	└ 60°		M30C-FWRK 187109		
With thumb-grip 	✓ 60°		M30C-FWKV 187102	1 unit	

3 positions¹⁾

With rotary head 	40° ↙↘ 40°		M30C-FW3 187089	1 unit	
	60° ↓ 60°		M30C-FWR3 187090		
	60° ↓ 60°		M30C-FWR3-X7 187107		
	60° ↓ 60°		M30C-FWR3-X94 187108		
	60° ↓ 60°	Customized inscription available	M30C-FWR3-* 187106		* = With customized Label Editor inscription → Page 74
With thumb-grip 	40° ↙↘ 40°		M30C-FWK3 187104	1 unit	
	60° ↓ 60°		M30C-FWRK3 187110		
	Selectable		M30C-FWRK3-* 187111		* = MAMO (for 60° ↓ 40°) or MOMA (for 40° ↙↘ 60°)

4 positions^{2), 3)}

With rotary head 			M30C-FWR4 187091	1 unit	
With thumb-grip 			M30C-FWRK4 187112	1 unit	

Notes
¹⁾ With plunger bridge for middle contact
²⁾ Not compatible with configuration adapters
³⁾ Use M22-A4 mounting adapter → Page 69

Action:	Lock mechanism	Key withdrawable at position	Information about equipment supplied	Part no. Article no.	Std. pack
---------	----------------	------------------------------	--------------------------------------	----------------------	-----------

▷ = Momentary (M0)
 ↓ = Maintained (MA)

Key-operated buttons for individual lock mechanisms

IP66
 Metal bezel
 Front dimensions: 36 mm diameter
 Maintained/momentary action can be changed with M22-XC-Y configuration adapters
 Key withdraw can be changed with M22-XC-... configuration adapters



2 positions



▷ 40°		0	-	-	With 1 key	M30C-FWS 187068	1 unit
↓ 60°		0	-	I		M30C-FWRS 187092	
↓ 60°		0	-	-		M30C-FWRS-A1 187047	
↓ 60°		I	-	II		M30C-FWRS-X95 187067	
▷ 40°	Selectable	0	-	-		M30C-FWS-MS* 187072	
↓ 60°	Selectable	0	-	I		M30C-FWRS-MS* 187048	
▷ 40°	MS2	0	-	-		M30C-FWS-MS2 187073	
▷ 40°	MS3	0	-	-		M30C-FWS-MS3 187074	
↓ 60°	MS3	0	-	I		M30C-FWRS-MS3 187053	
↓ 60°	MS4	0	-	I		M30C-FWRS-MS4 187055	
↓ 60°	MS5	0	-	I		M30C-FWRS-MS5 187057	
▷ 40°	MS5	0	-	-		M30C-FWS-MS5 187075	
↓ 60°	MS6	0	-	I		M30C-FWRS-MS6 187059	
↓ 60°	MS7	0	-	I		M30C-FWRS-MS7 187060	
↓ 60°	MS8	0	-	I		M30C-FWRS-MS8 187061	
↓ 60°	MS10	0	-	I		M30C-FWRS-MS10 187051	
↓ 60°	Selectable	0	-	-		M30C-FWRS-MS*-A1 187049	
↓ 60°	MS3	0	-	-		M30C-FWRS-MS3-A1 187054	
↓ 60°	MS4	0	-	-		M30C-FWRS-MS4-A1 187056	
↓ 60°	MS5	0	-	-		M30C-FWRS-MS5-A1 187058	
↓ 60°	MS10	0	-	-		M30C-FWRS-MS10-A1 187052	
↓ 60°	Selectable	-	-	I		M30C-FWRS-MS*-A21-* 187050	
↓ 60°	Ronis 455	0	-	I	With 2 keys	M30C-FWRS-RS 187062	1 unit
↓ 60°	Ronis 455	0	-	-		M30C-FWRS-RS-A1 187063	













Action:	Lock mechanism	Key withdrawable at position	Information about equipment supplied	Part no. Article no.	Std. pack
---------	----------------	------------------------------	--------------------------------------	----------------------	-----------

 = Momentary (M0)
 = Maintained (MA)

Key-operated buttons for individual lock mechanisms

3 positions

	40°  40°		0	-	-	With 1 key	M30C-FWS3 187069	1 unit
	40°  40°	Selectable	0	-	-		M30C-FWS3-MS* 187070	
	60°  60°		0	I	II		M30C-FWRS3 187094	
	60°  60°	Selectable	-	Selectable	-		M30C-FWRS3-MS*-A* 187096	
	60°  60°		-	Selectable	-		M30C-FWRS3-A* 187095	
	60°  60°	MS3	0	-	II		M30C-FWRS3-MS3 187097	
	60°  60°	Ronis 455	0	I	II	With 2 keys	M30C-FWRS3-RS 187098	1 unit
	60°  60°	Ronis 455	0	-	-		M30C-FWRS3-RS-A1 187099	





2 or 3 positions

	Selectable		-	-	-	With 1 key	M30C-FWRS*-MS*-* 187093	1 unit
---	------------	--	---	---	---	------------	-----------------------------------	--------





Key-operated buttons for master key systems

Metal bezel
 IP66
 Front dimensions: 36 mm diameter
 To order, use form MZ047002ZU (formerly FO276)
 → Data sheet in online catalog
 Delivery will take 4 to 6 weeks after the order is received at the factory









2 positions

	 40°		0	-	-	With 2 keys	M30C-FWS-SA(*)-* 187076	1 unit
	 60°		0	-	-		M30C-FWRS-SA(*)-* 187064	
	 60°		0	-	I		M30C-FWRS-SA(*)-A8 187066	

3 positions

	40°  40°		0	-	-	With 2 keys	M30C-FWS3-SA(*)-* 187071	1 unit
	60°  60°		0	-	-		M30C-FWRS3-SA(*)-* 187100	
	60°  60°		0	I	II		M30C-FWRS3-SA(*)-A9 187101	

Notes

MS*: * = MS2, ..., MS20; (enter lock mechanism number in the part no.)
 A*: * = 1, action: , withdrawable in position 0
 * = 2, action: , withdrawable in positions I, 0
 * = 3, action: , withdrawable in positions 0, II
 * = 4, action: , withdrawable in positions I, 0
 * = 5, action: , withdrawable in position 0
 * = 6, action: , withdrawable in positions 0, II
 * = 7, action: , withdrawable in position 0
 * = 10, action: , withdrawable in positions I, II (not for item M30C-FWRS3-A*)
 -*: * = Customized inscription with Label Editor; replace * with the automatically assigned filename (→ Page 74) or "blank" if no inscription is required
 WRS*: 2 or 3 positions (action and key withdraw as M22-WRS or M22-WRS3)

Action:

▷ = Momentary (MO)

∨ = Maintained (MA)

Part no.

Article no.

Std. pack



Joysticks

With one operating point per operating direction
With metal shaft
IP66
Metal bezel
Front dimensions: 36 mm diameter

Positions	Action	Part no. Article no.	Std. pack
2 positions	—	M30C-FWRJS2H 187078	1 unit
2 positions		M30C-FWRJS2V 187065	
4 positions	↕	M30C-FWJS4 187077	



Indicator lights



























IP67
Metal bezel
Front dimensions: 36 mm diameter

Color	Lens	Part no. Article no.	Std. pack
White	○	M30C-FL-W 183287	1 unit
Red	●	M30C-FL-R 183282	
Green	●	M30C-FL-G 183283	
Yellow	●	M30C-FL-Y 183285	
Blue	●	M30C-FL-B 183284	
Orange	●	M30C-FL-A 183286	
* = With customized Label Editor inscription → Page 74			
White	○	M30C-FL-W-* 183293	
Red	●	M30C-FL-R-* 183288	
Green	●	M30C-FL-G-* 183289	
Yellow	●	M30C-FL-Y-* 183291	
Blue	●	M30C-FL-B-* 183290	
Orange	●	M30C-FL-A-* 183292	

Button plate **Part no.** Std. pack
Article no.

Illuminated pushbutton actuators

IP67, IP69K
Metal bezel
Front dimensions: 36 mm diameter
Flush

Button plate	Part no.	Std. pack	
Article no.			
Illuminated pushbutton actuators			
IP67, IP69K Metal bezel Front dimensions: 36 mm diameter Flush			
Momentary 		M30C-FDL-W 182925	1 unit
		M30C-FDL-R 182926	
		M30C-FDL-G 182927	
		M30C-FDL-Y 182928	
		M30C-FDL-B 182940	
		M30C-FDL-A 182924	
		M30C-FDL-W-X0 182929	
		M30C-FDL-W-X1 182930	
		M30C-FDL-W-X100 182966	
		M30C-FDL-R-X0 182958	
		M30C-FDL-G-X1 182957	
		M30C-FDL-G-X32 182968	
		M30C-FDL-Y-X162 182965	
Momentary 	Without button plate	M30C-FDL-X 182941	1 unit
Maintained¹⁾ 		M30C-FDRL-W 182950	1 unit
		M30C-FDRL-R 182951	
		M30C-FDRL-G 182952	
		M30C-FDRL-Y 182953	
		M30C-FDRL-B 182954	
		M30C-FDRL-A 182949	
		M30C-FDRL-W-X0 182934	
		M30C-FDRL-W-X1 182935	
		M30C-FDRL-R-X0 182933	
		M30C-FDRL-G-X1 182932	
Maintained¹⁾ 	Without button plate	M30C-FDRL-X 182955	1 unit

Notes ¹⁾ Maintained/momentary action can be changed on device

Resistance	Scale/inscription	Contact sequence	Part no. Article no.	Std. pack
R				
kΩ				



Potentiometers, IP65

3 individual screw connections
Resistance accuracy: ±10% (linear)
Metal bezel
Rated power P = 0.5 W

1	Standard scale/inscription		M30C-FR1K 187029	1 unit
4.7			M30C-FR4K7 187030	
10			M30C-FR10K 187035	
47			M30C-FR47K 187031	
100			M30C-FR100K 187032	
470			M30C-FR470K 187033	
2.2			M30C-FR2K2 187034	
22			M30C-FR22K 187036	
1000			M30C-FR1M 187037	
1	Without scale/inscription		M30C-FR1K-BLANK 187038	
2.2			M30C-FR2K2-BLANK 187039	
4.7			M30C-FR4K7-BLANK 187040	
10			M30C-FR10K-BLANK 187041	
22			M30C-FR22K-BLANK 187042	
47			M30C-FR47K-BLANK 187043	
100			M30C-FR100K-BLANK 187044	
470			M30C-FR470K-BLANK 187045	
1000			M30C-FR1M-BLANK 187046	
Selectable ¹⁾	Selectable ²⁾		M30C-FR*.* 187081	

SmartWire-DT potentiometers, IP65

Only in conjunction with M22-SWD-R function element



–	Silver bezel M22		M22-R-SWD 179292	1 unit
---	---------------------	--	----------------------------	--------



–	Metal bezel Flat Front		M30C-FR-SWD 187080	1 unit
---	---------------------------	--	------------------------------	--------

SmartWire-DT encoders, IP65

With actuation function
Only in conjunction with M22-SWD-INC function element



–	Silver bezel M22	–	M22-INC-SWD 179981	1 unit
---	---------------------	---	------------------------------	--------



–	Metal bezel Flat Front	–	M30C-FINC-SWD 187079	1 unit
---	---------------------------	---	--------------------------------	--------

Notes

¹⁾ Wildcard: Available resistance values:
1K = 1 kΩ, 2K2 = 2.2 kΩ, 4K7 = 4.7 kΩ, 10K = 10 kΩ,
22K = 22 kΩ, 47K = 47 kΩ, 100K = 100 kΩ, 470K = 470 kΩ, 1M = 1 MΩ
²⁾ Wildcard: Standard scale/inscription: X1000 Without scale/inscription: "-"

1.6

RMQ-Titan pilot devices

Mounting adapters, contact elements

Moeller series

1

	Configuration	Part no. Article no.	Std. pack
--	---------------	-------------------------	-----------

Mounting adapters

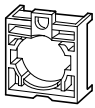

Mounting adapter (front mounting) for 3 contact/LED elements
For M22-(C)K... contact elements and M22-(C)LED... LED elements.
Sequence numbers on mounting adapter



M22-A
216374 50 units

M22-A-GVP
216375 500 units

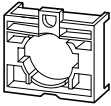

Mounting adapter (front mounting) for 4 contact elements,
can be used with M22-WR4, M22-D4, M22-WJ..., M22-WRJ...
For M22-(C)K contact elements

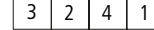

M22-A4
279437 10 units

Terminal type	Contact configuration: ⊕ = Safety function implemented with positive opening as specified in IEC/EN 60947-5-1	Contact sequence	Contact travel diagram, stroke in connection with front element	Configuration	Part no. Article no.	Std. pack
---------------	--	------------------	---	---------------	-------------------------	-----------

Contact elements

Front mounting

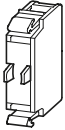

Screw terminals	1 N/O				M22-K10 216376 20 units
	1 N/O				M22-K10-GVP 216377 500 units
1 N/O					M22-K10P 110835 20 units
1 N/C ⊕					M22-K01 216378 20 units
1 N/C ⊕					M22-K01-GVP 216379 500 units
1 N/C ⊕					M22-K01D 262165 20 units

Base mounting

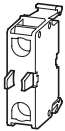

Screw terminals	1 N/O				M22-KC10 216380 20 units
	1 N/O				M22-KC10-GVP 216381 200 units
1 N/C ⊕					M22-KC01 216382 20 units
1 N/C ⊕					M22-KC01-GVP 216383 200 units

Front mounting

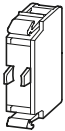

Spring-clamp terminals	1 N/O				M22-CK10 216384 20 units
	1 N/C ⊕				M22-CK01 216385 20 units
	1 N/C ⊕				M22-CK01D 262510 20 units

Base mounting

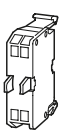

Spring-clamp terminals	1 N/O				M22-CKC10 216386 20 units
	1 N/C ⊕				M22-CKC01 216387 20 units

Terminal type	Contact configuration: ☉ = Safety function implemented with positive opening as specified in IEC/EN 60947-5-1	Contact sequence	Contact travel diagram, stroke in connection with front element	Configuration	Part no. Article no.	Std. pack
---------------	--	------------------	---	---------------	----------------------	-----------

Self-monitoring contact elements

N/O is actuated when mounted on the pushbutton.

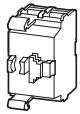
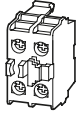
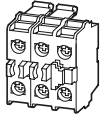
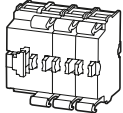
Front mounting 	Screw terminals	1 N/O 1 N/C ☉				M22-K01SMC10 121472	1 unit
		1 N/O 2 N/C ☉				M22-K02SMC10 121474	
Base mounting   	Screw terminals	1 N/O 1 N/C ☉				M22-KC01SMC10 121473	1 unit
		1 N/O 2 N/C ☉				M22-KC02SMC10 121720	
		1 N/O 3 N/C ☉			—	M22-KC03SMC10¹⁾ 173028	
		2 N/O 2 N/C ☉			—	M22-KC12SMC10¹⁾ 173029	

Signal contact actuator for SMC

For actuating the N/O contact in self-monitoring M22-...03(12)SMC10 contact elements
Required for two-channel version with additional signaling (auxiliary) contact

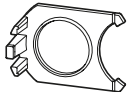
						M22-XSMC 173030	10 units
---	--	--	--	--	--	---------------------------	----------

Double-contact elements

Front mounting.
When using M22-PV... emergency stop buttons, max. 2 contact elements = 4 N/C / N/O

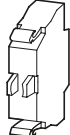
	Cage Clamp	2 N/O			—	M22-CK20 107898	20 units
		2 N/C			—	M22-CK02 107899	
		1 N/O 1 N/C ☉			—	M22-CK11 107940	

Notes ¹⁾ The N/O is actuated when mounted with M22-XSMC.

Configuration of mounting adapter with sequence numbers as defined in EN 50013



x = Sequence number on mounting adapter
y = Function number on contact element

1.6

RMQ-Titan pilot devices

Moeller series







Complete modules

1

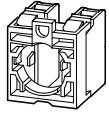
Terminal type	Contact configuration: ⊕ = Safety function implemented with positive opening as defined in IEC/EN 60947-5-1	Contact sequence	Contact travel diagram, stroke in connection with front element	Configuration	Part no. Article no.	Std. pack
---------------	--	------------------	---	---------------	----------------------	-----------

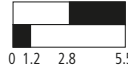
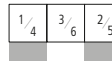
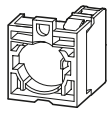
Complete modules

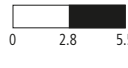
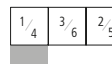
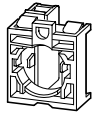
Combination of contact element with screw terminals and mounting adapter, front mounting

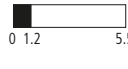
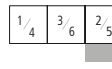
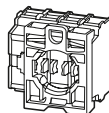
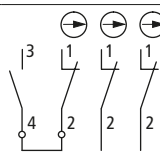
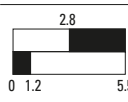
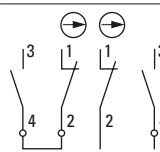
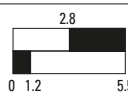
	1 N/O 1 N/C ⊕				M22-AK11 216505	5 units
	1 N/O				M22-AK10 216504	
	1 N/C ⊕				M22-AK01 216503	
	1 N/O 3 N/C ⊕			—	M22-AK03SMC10 173026	1 unit
	2 N/O 2 N/C ⊕			—	M22-AK12SMC10 173027	1 unit

Notes Configuration of mounting adapter with sequence numbers as defined in EN 50013



x = Sequence number on mounting adapter
y = Function number on contact element

Rated operating voltage U_e V	Rated operational current I_e mA	Power consumption P W	Color	Part no. Article no.	Std. pack
---------------------------------------	--	-----------------------------	-------	-------------------------	-----------

LED elements with screw terminals

→ Page 75

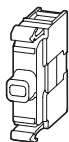
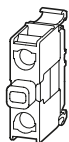

Rated operating voltage	Rated operational current	Power consumption	Color	Part no. Article no.	Std. pack	
Front mounting 	12 - 30 V AC/DC	8 - 15	0.26 at 24 V	○	M22-LED-W 216557	20 units
				●	M22-LED-R 216558	
				●	M22-LED-G 216559	
				●	M22-LED-B 218057	
85 - 264 V AC, 50/60 Hz	5 - 15	0.33 at 230 V	○	M22-LED230-W 216563	20 units	
				●		M22-LED230-R 216564
				●		M22-LED230-G 216565
				●		M22-LED230-B 218059
85 - 264 V AC, 50/60 Hz	5 - 15	0.33 at 230 V	○	M22-LED230TA-W¹⁾ 182905	20 units	
				●		M22-LED230TA-R¹⁾ 182906
				●		M22-LED230TA-G¹⁾ 182907
				●		M22-LED230TA-B¹⁾ 182908
207 - 264 V AC, 50/60 Hz	12 - 15	0.33 at 230 V	–	M22-LED230H-²⁾ 106521	20 units	
Base mounting 	12 - 30 V AC/DC	8 - 15	0.26 at 24 V	○	M22-LEDC-W 216560	20 units
				●	M22-LEDC-R 216561	
				●	M22-LEDC-G 216562	
				●	M22-LEDC-B 218058	
85 - 264 V AC, 50/60 Hz	5 - 15	0.33 at 230 V	○	M22-LEDC230-W 216566	20 units	
				●		M22-LEDC230-R 216567
				●		M22-LEDC230-G 216568
				●		M22-LEDC230-B 218060
207 - 264 V AC, 50/60 Hz	12 - 15	0.33 at 230 V	–	M22-LEDC230H-²⁾ 106522	20 units	

Notes

- ¹⁾ With interference signal protection
- ²⁾ Replace * with color:
W = White, R = Red, G = Green, B = Blue



For pushbuttons, indicator lights, illuminated pushbutton actuators, and illuminated selector switches, the following applies:
M22...-R only in combination with M22-LED...-R
M22...-G only in combination with M22-LED...-G
M22...-W only in combination with M22-LED...-W
M22...-Y only in combination with M22-LED...-W
M22...-B in combination with M22-LED...-W or M22-LED...-B

Rated operating voltage	Rated operational current	Power consumption	Color	Part no. Article no.	Std. pack
U_e V	I_e mA	P W			

LED elements with Cage Clamp

→ Page 75
Cage Clamp is a registered trademark of Wago Kontakttechnik GmbH, Minden, Germany

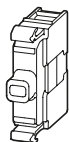

Mounting	Rated operating voltage	Rated operational current	Power consumption	Color	Part no. Article no.	Std. pack
Front mounting 	12 - 30 V AC/DC	8 - 15	0.26 at 24 V		M22-CLED-W 216569	20 units
					M22-CLED-R 216570	
					M22-CLED-G 216571	
					M22-CLED-B 218061	
	85 - 264 V AC, 50/60 Hz	5 - 15	0.33 at 230 V		M22-CLED230-W 216575	20 units
					M22-CLED230-R 216576	
					M22-CLED230-G 216577	
					M22-CLED230-B 218063	
Base mounting 	12 - 30 V AC/DC	8 - 15	0.26 at 24 V		M22-CLEDC-W 216572	20 units
					M22-CLEDC-R 216573	
					M22-CLEDC-G 216574	
					M22-CLEDC-B 218062	
	85 - 264 V AC, 50/60 Hz	5 - 15	0.33 at 230 V		M22-CLEDC230-W 216578	20 units
					M22-CLEDC230-R 216579	
					M22-CLEDC230-G 216580	
					M22-CLEDC230-B 218064	

Notes
For pushbuttons, indicator lights, illuminated pushbutton actuators, and illuminated selector switches, the following applies:
M22...-R only in combination with M22-LED...-R
M22...-G only in combination with M22-LED...-G
M22...-W only in combination with M22-LED...-W
M22...-Y only in combination with M22-LED...-Y
M22...-B in combination with M22-LED...-W or M22-LED...-B

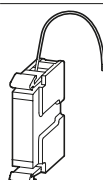

LED series elements with screw terminals

Front and base mounting → Page 75

LED element	Rated operating voltage	Part no. Article no.	Std. pack
LED resistor element For connecting 12 - 30 V LED elements	42 - 60 V AC/DC	M22-XLED60 231078	10 units
	220 V AC/DC	M22-XLED220¹⁾ 271541	
LED test element For decoupled function test (lamp test)	12 - 240 V AC/DC	M22-XLED-T 231079	
	85 - 264 V AC	M22-XLED230-T 231080	

Notes
¹⁾ Maximum ambient temperature: -25 °C to +55 °C
The LED's brightness will be reduced.

Terminal type	Contact configuration: ⊕ = Safety function implemented with positive opening as defined in IEC/EN 60947-5-1	Contact sequence	Contact travel diagram, stroke in connection with front element	Part no. Article no.	Std. pack
---------------	--	------------------	---	-------------------------	-----------

Front mounting

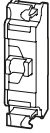

Contact elements (Flat Rear with Cage Clamp, push-in)

→ Page 75

Cage Clamp is a registered trademark of Wago Kontakttechnik GmbH, Minden, Germany

Cage Clamp, push-in	1 N/C ⊕			M22-FK01 180791	20 units
	1 N/O			M22-FK10 180792	

Front mounting

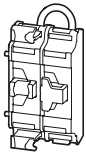

Self-monitoring contact element (Flat Rear with Cage Clamp, push-in)

N/O is actuated when mounted on the pushbutton.

Cage Clamp, push-in	1 N/C ⊕			M22-FK01SMC10 180793	1 unit

Complete assembly (Flat Rear with Cage Clamp, push-in)

Combination of contact element and self-monitoring contact element M22-FK01SMC10, M22-A mounting adapter, and M22-XSMC signal contact actuator. The N/O in the self-monitoring contact element is actuated when mounted with M22-XSMC.

Cage Clamp, push-in	3 N/C ⊕			M22-AFK03SMC10 180794	1 unit

Rated operating voltage	Rated operational current	Power consumption	Color	Part no. Article no.	Std. pack
U_e V	I_e mA	P W			

Front mounting

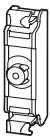

LED elements (Flat Rear with Cage Clamp, push-in)



12 - 30 V AC/DC, 50/60 Hz (standard: 24 V AC/DC)	8 - 15	0.26 at 24 V		M22-FLED-W 180795	20 units
12 - 30 V AC/DC, 50/60 Hz (standard: 24 V AC/DC)	8 - 15	0.26 at 24 V		M22-FLED-B 180796	
12 - 30 V AC/DC, 50/60 Hz (standard: 24 V AC/DC)	8 - 15	0.26 at 24 V		M22-FLED-G 180797	
12 - 30 V AC/DC, 50/60 Hz (standard: 24 V AC/DC)	8 - 15	0.26 at 24 V		M22-FLED-R 180798	
24 V DC	10 - 15	0.36 at 24 V		M22-FLED-RG¹⁾ 180799	
24 V DC	8 - 15	0.36 at 24 V		M22-FLED-RGB¹⁾ 180800	

Notes

¹⁾

	Terminal color			
	X1	X2	X3	X4
	+R	+G	+B	GND
M22-FLED-RG	Red	x		x
	Green		x	x
	Yellow	x	x	x
M22-FLED-RGB	Red	x		x
	Green		x	x
	Yellow	x	x	x
	White	x	x	x
	Blue		x	x
	Violet	x	x	x
	Turquoise		x	x











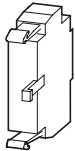

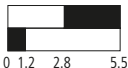
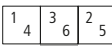

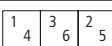
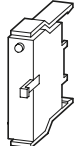

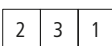

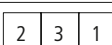
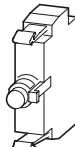

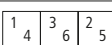



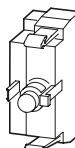

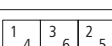



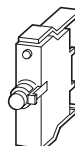

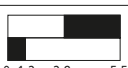
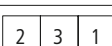
1.6

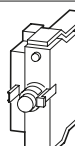

RMQ-Titan pilot devices

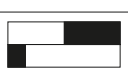
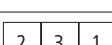
SmartWire-DT function elements

Moeller series

1

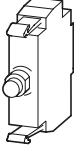
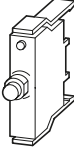
	Number of contacts	Contact sequence	Contact travel diagram, stroke in connection with front element	Configuration	LED color	Part no. Article no.	Std. pack
Function elements							
Front mounting 	1		 0 1.2 2.8 5.5		No LED	M22-SWD-K11 115964	20 units
	2		 0 1.2 2.8 5.5		No LED	M22-SWD-K22 115965	10 units
Base mounting 	1		 0 1.2 2.8 5.5		No LED	M22-SWD-KC11 115995	20 units
	2		 0 1.2 2.8 5.5		No LED	M22-SWD-KC22 115996	10 units
Front mounting 	1		 0 1.2 2.8 5.5			M22-SWD-K11LED-W 115972	20 units
						M22-SWD-K11LED-B 115973	
						M22-SWD-K11LED-G 115974	
						M22-SWD-K11LED-R 115975	
	2		 0 1.2 2.8 5.5			M22-SWD-K22LED-W 115978	10 units
						M22-SWD-K22LED-B 115979	
						M22-SWD-K22LED-G 115980	
						M22-SWD-K22LED-R 115981	
Base mounting 	1		 0 1.2 2.8 5.5			M22-SWD-K11LEDC-W 116003	20 units
						M22-SWD-K11LEDC-B 116004	
						M22-SWD-K11LEDC-G 116005	
						M22-SWD-K11LEDC-R 116006	
	2		 0 1.2 2.8 5.5			M22-SWD-K22LEDC-W 116009	10 units
						M22-SWD-K22LEDC-B 116010	
						M22-SWD-K22LEDC-G 116011	
						M22-SWD-K22LEDC-R 116012	

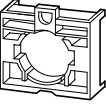
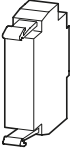
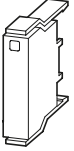
		Configuration	LED color	Part no. Article no.	Std. pack						
LED elements											
Front mounting 		<table border="1"> <tr> <td>1</td> <td>3</td> <td>2</td> </tr> <tr> <td>4</td> <td>6</td> <td>5</td> </tr> </table>	1	3	2	4	6	5	○	M22-SWD-LED-W 115966	20 units
			1	3	2						
			4	6	5						
			●	M22-SWD-LED-B 115967							
●	M22-SWD-LED-G 115968										
●	M22-SWD-LED-R 115969										
Base mounting 		<table border="1"> <tr> <td>2</td> <td>3</td> <td>1</td> </tr> </table>	2	3	1	○	M22-SWD-LEDC-W 115997	20 units			
			2	3	1						
			●	M22-SWD-LEDC-B 115998							
			●	M22-SWD-LEDC-G 115999							
●	M22-SWD-LEDC-R 116000										
Mounting adapters											
Front mounting 	For 1 M22-SWD-K...function element or M22-SWD-LED...LED element In addition, 1 or 2 M22-K... contact elements possible Sequence number on mounting adapter	<table border="1"> <tr> <td>1/4</td> <td>3/6</td> <td>2/5</td> </tr> </table>	1/4	3/6	2/5	—	M22-A 216374	50 units			
1/4	3/6	2/5									
	For 2 M22-SWD-K22...function elements For use with M22-WR4, M22-WRJ4, M22-D4 in conjunction with M22-(SWD)-K	<table border="1"> <tr> <td>1</td> <td>4</td> <td>2</td> <td>3</td> </tr> </table>	1	4	2	3	—	M22-SWD-A4 116016	10 units		
1	4	2	3								
IP20 universal modules											
Front mounting 	For SmartWire-DT modules that have been configured as part of the SmartWire-DT system but have not yet been installed on the SWD ribbon cable			M22-SWD-NOP 147637	20 units						
Base fixing 	For SmartWire-DT modules that have been configured as part of the SmartWire-DT system but have not yet been installed on the M22-SWD-I... printed circuit board			M22-SWD-NOPC 147638	20 units						

WWW.TM2A.PT info@tm2a.pt

WWW.TM2A.PT info@tm2a.pt

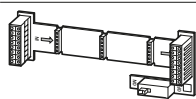

Printed circuit boards

PCBs for M22-I... surface mounting enclosure for housing
M22-SWD...K base mounting function elements
Integrated, connectable SmartWire-DT bus termination resistor

	Part no. Article no.	Std. pack
Number of mounting locations: 1	M22-SWD-I1-LP01 115990	1 unit
Number of mounting locations: 2	M22-SWD-I2-LP01 115991	
Number of mounting locations: 3	M22-SWD-I3-LP01 115992	
Number of mounting locations: 4	M22-SWD-I4-LP01 115993	
Number of mounting locations: 6	M22-SWD-I6-LP01 115994	

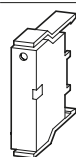

Link

Used to link open mounting locations on
device plugs or M22-SWD-I PCB

Link for unused mounting locations on M22-SWD-I...LP (base mounting)	M22-SWD-SEL8-10 116698	5 units
---	----------------------------------	---------

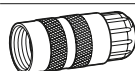

8-pin socket, straight	SWD4-SF8-67 116033	1 unit
------------------------	------------------------------	--------

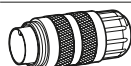

8-pin plug, flat	SWD4-SM8-67 116034	
------------------	------------------------------	--

Housing bushing sockets

For installation in surface mounting enclosure M22-I...
8-pin socket/plug, IP67, for connection to SWD4-S(M,F)-67...
8 prefabricated cables for connection to M22-SWD-I... PCB

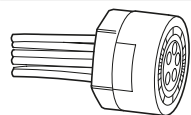

8-pin socket, M20	SWD4-SF8-20 116031	1 unit
-------------------	------------------------------	--------

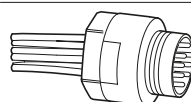

8-pin plug, M20	SWD4-SM8-20 116032	1 unit
-----------------	------------------------------	--------

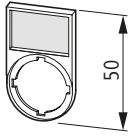





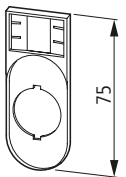
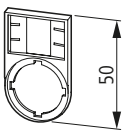





















Inscription	Part no. Article no.	Std. pack	Inscription	Part no. Article no.	Std. pack
Legend holders, complete					
IP66 30 x 50 mm, round, black (RAL 9005)					
- 0 I	M22S-ST-X88 216485	10 units	FAULT	M22S-ST-GB8 216498	10 units
0 - I	M22S-ST-X89 218147		DÉFAUT	M22S-ST-F67 256795	
I 0 II	M22S-ST-X93 216486		BETRIEB	M22S-ST-D7 216488	
1	M22S-ST-X52 256797		RUN	M22S-ST-GB7 216497	
2	M22S-ST-X53 256798		EN SERVICE	M22S-ST-F7 256793	
STOP	M22S-ST-GB0 216494		HAND AUTO	M22S-ST-D11 216492	
START	M22S-ST-GB1 216495		MAN. AUTO	M22S-ST-GB11 216500	
AUS	M22S-ST-D5 218299		AUS EIN	M22S-ST-D10 216490	
OFF	M22S-ST-GB5 218300		OFF ON	M22S-ST-GB10 216499	
ARRÊT	M22S-ST-F0 256791		ARRÊT MARCHÉ	M22S-ST-F10 256794	
EIN	M22S-ST-D6 216487		HAND 0 AUTO	M22S-ST-D12 216493	
ON	M22S-ST-GB6 216496		MAN. 0 AUTO	M22S-ST-GB12 216501	
MARCHE	M22S-ST-F1 256792		SOUS TENSION	M22S-ST-F68 256796	
STÖRUNG	M22S-ST-D8 216489				

Inscription	Color	Part no. Article no.	Std. pack	Notes
Legend holders without label				
IP66 Round, black (RAL 9005)				
30 x 50 mm	●	M22S-ST-X 216392	25 units	Cannot be used for M22(S)-PV...
30 x 50 mm	●	M22S-ST-X-GVP 216393	500 units	
For double actuator pushbuttons 30 x 75 mm	●	M22S-STDD-X 216394	10 units	--



Insert labels for label mounts				
18 x 27 mm				
	Aluminum color, no inscription	--	M22-XST 216480	100 units --
	Aluminum color, no inscription	--	M22-XST-GVP 216481	500 units --
	* = With customized Label Editor inscription → Page 74	--	M22-XST-* 216482	1 unit Letter height of 3 mm: Max. 3 lines, Max. 12 characters per line Letter height of 5 mm: Max. 2 lines, Max. 8 characters per line

Inscription or explanation	For use with	Color, symbol	Style: flush	Style: extended	Std. pack
			Part no. Article no.	Part no. Article no.	
Button plates for pushbuttons					
≤ 5 characters: letter height of 5 mm, > 5 characters: letter height of 3 mm					
–	M22(S)-D-X M22(S)-DR-X		M22-XD-S 216421	M22-XDH-S 216428	10 units
–	M22-DG-X M30C-FD-X M30C-FDR-X		M22-XD-W 216422	M22-XDH-W 216429	
–			M22-XD-R 216423	M22-XDH-R 216430	
–			M22-XD-G 216424	M22-XDH-G 216431	
–			M22-XD-Y 216425	M22-XDH-Y 216432	
–			M22-XD-B 216426	M22-XDH-B 216433	
–			M22-XD-GR 132670		
With customized Label Editor inscription → Notes		–	M22-XD-*.* 216427	M22-XDH-*.* 216434	
Zu			M22-XD-S-D2 218184	M22-XDH-S-D2 218229	
Auf			M22-XD-S-D3 218185	M22-XDH-S-D3 218230	
Ab			M22-XD-S-D4 218186	M22-XDH-S-D4 218231	
Aus			M22-XD-R-D5 218187	M22-XDH-R-D5 218232	
Ein			M22-XD-S-D6 218188	M22-XDH-S-D6 218233	
Entsperren			M22-XD-B-D14 218189	M22-XDH-B-D14 218234	
Vorwärts			M22-XD-S-D15 218190	M22-XDH-S-D15 218235	
Rückwärts			M22-XD-S-D16 218191	M22-XDH-S-D16 218236	
Heben			M22-XD-S-D17 218192	M22-XDH-S-D17 218237	
Senken			M22-XD-S-D18 218193	M22-XDH-S-D18 218238	
STOP			M22-XD-R-GB0 218194	M22-XDH-R-GB0 218239	
STOP			M22-XD-S-GB0 218195	M22-XDH-S-GB0 218240	
START			M22-XD-G-GB1 218196	M22-XDH-G-GB1 218241	
START			M22-XD-W-GB1 218197	M22-XDH-W-GB1 218242	
CLOSE			M22-XD-S-GB2 218198	M22-XDH-S-GB2 218243	
UP			M22-XD-S-GB3 218199	M22-XDH-S-GB3 218244	
DOWN			M22-XD-S-GB4 218200	M22-XDH-S-GB4 218245	
TEST			M22-XD-S-GB9 218201	M22-XDH-S-GB9 218246	
OFF			M22-XD-R-GB5 218202	M22-XDH-R-GB5 218247	
ON			M22-XD-S-GB6 218203	M22-XDH-S-GB6 218248	

Notes

- When ordering, replace the asterisks in part no. M22-XD(H)-*-* as follows:
 1. Wildcard \triangle Color: -R (red), -G (green), -B (blue), -W (white), -Y (yellow), -S (black), -U (grey)
 2. Wildcard \triangle Filename assigned by Label Editor → Page 74

Text size of 3 mm:
 Max. 8 characters in 1st line,
 10 characters in 2nd line, 8 characters
 in 3rd line



Text size of 5 mm:
 Max. 5 characters per line



Inscription or explanation	For use with	Color, symbol	Style: flush	Style: extended	Std. pack
			Part no. Article no.	Part no. Article no.	
Button plates for pushbuttons					
≤ 5 characters: letter height 5 of mm > 5 characters: letter height of 3 mm					
RESET	M22(S)-D-X M22(S)-DR-X		M22-XD-B-GB14 218204	M22-XDH-B-GB14 218249	10 units
FORWARD	M22-DG-X M30C-FD-X M30C-FDR-X		M22-XD-S-GB15 218205	M22-XDH-S-GB15 218250	
REVERSE			M22-XD-S-GB16 218206	M22-XDH-S-GB16 218251	
RAISE			M22-XD-S-GB17 218208	M22-XDH-S-GB17 218252	
LOWER			M22-XD-S-GB18 218209	M22-XDH-S-GB18 218253	
Stop			M22-XD-R-X0 218153	M22-XDH-R-X0 218155	
Stop			M22-XD-S-X0 218154	M22-XDH-S-X0 218156	
Start			M22-XD-G-X1 218165	M22-XDH-G-X1 218210	
Start			M22-XD-S-X1 218166	M22-XDH-S-X1 218211	
Start			M22-XD-W-X1 218167	M22-XDH-W-X1 218212	
Start			M22-XD-G-X2 218168	M22-XDH-G-X2 218213	
Start			M22-XD-S-X2 218169	M22-XDH-S-X2 218214	
Increase			M22-XD-S-X4 218170	M22-XDH-S-X4 218215	
Decrease			M22-XD-S-X5 218171	M22-XDH-S-X5 218216	
Reset			M22-XD-B-X6 218172	M22-XDH-B-X6 218217	
Direction of movement			M22-XD-S-X7 218173	M22-XDH-S-X7 218218	
Direction of movement			M22-XD-S-X8 218174	M22-XDH-S-X8 218219	
Manual			M22-XD-S-X9 218175	M22-XDH-S-X9 218220	
Automatic			M22-XD-S-X10 218176	M22-XDH-S-X10 218221	
Inch			M22-XD-S-X11 218177	M22-XDH-S-X11 218222	
Unlock			M22-XD-S-X12 218178	M22-XDH-S-X12 218223	
Unclamp			M22-XD-S-X13 218179	M22-XDH-S-X13 218224	
Clamp			M22-XD-S-X14 218180	M22-XDH-S-X14 218225	
Release			M22-XD-S-X15 218181	M22-XDH-S-X15 218226	
Liquid			M22-XD-S-X16 218182	M22-XDH-S-X16 218227	
Klaxon			M22-XD-S-X17 218183	M22-XDH-S-X17 218228	

Inscription or explanation	For use with	Color	Part no. Article no.	Std. pack
Button plates for mushroom pushbuttons				
≤ 5 characters: letter height 5 of mm > 5 characters: letter height of 3 mm				
-	M22(S)-D(R)P-...	●	M22-XDP-S 216435	10 units
-		○	M22-XDP-W 216436	
-		●	M22-XDP-R 216437	
-		●	M22-XDP-G 216438	
-		●	M22-XDP-Y 216439	
With customized Label Editor inscription → Notes		-	M22-XDP-*./*.* 216440	
Zu		●	M22-XDP-S-D2 218272	
Auf		●	M22-XDP-S-D3 218273	
Ab		●	M22-XDP-S-D4 218274	
Aus		●	M22-XDP-R-D5 218275	
Ein		●	M22-XDP-S-D6 218276	
Vorwärts		●	M22-XDP-S-D15 218277	
Rückwärts		●	M22-XDP-S-D16 218278	
Heben		●	M22-XDP-S-D17 218279	
Senken		●	M22-XDP-S-D18 218280	
STOP		●	M22-XDP-R-GB0 218281	
STOP		●	M22-XDP-S-GB0 218282	
START		●	M22-XDP-G-GB1 218283	
START		○	M22-XDP-W-GB1 218284	
CLOSE		●	M22-XDP-S-GB2 218285	
UP		●	M22-XDP-S-GB3 218286	
DOWN		●	M22-XDP-S-GB4 218287	
OFF		●	M22-XDP-R-GB5 218289	
ON		●	M22-XDP-S-GB6 218290	
TEST		●	M22-XDP-S-GB9 218288	
FORWARD		●	M22-XDP-S-GB15 218291	
REVERSE		●	M22-XDP-S-GB16 218292	

Notes

- The following information must be added to the part no. when ordering:
 1. Wildcard * Δ Color: -R (red), -G (green), -B (blue), -W (white), -Y (yellow), -S (black), -U (grey)
 2. Wildcard * Δ Filename assigned by Label Editor → Page 74

Text size of 3 mm:























Max. 8 characters in first line,
 10 characters in second line,
 8 characters in third line



Text size of 5 mm:



























Max. 5 characters per line



Inscription or explanation	For use with	Color, symbol	Part no. Article no.	Std. pack
Button plates for mushroom pushbuttons				
≤ 5 characters: letter height 5 of mm > 5 characters: letter height of 3 mm				
RAISE	M22(S)-D(R)P-...		M22-XDP-S-GB17 218293	10 units
LOWER			M22-XDP-S-GB18 218294	
Stop			M22-XDP-R-X0 218157	
Stop			M22-XDP-S-X0 218158	
Start			M22-XDP-G-X1 218254	
Start			M22-XDP-S-X1 218255	
Start			M22-XDP-W-X1 218256	
Start			M22-XDP-G-X2 218257	
Start			M22-XDP-S-X2 218258	
Increase			M22-XDP-S-X4 218259	
Decrease			M22-XDP-S-X5 218260	
Direction of movement			M22-XDP-S-X7 218261	
Direction of movement			M22-XDP-S-X8 218262	
Manual			M22-XDP-S-X9 218263	
Automatic			M22-XDP-S-X10 218264	
Inch			M22-XDP-S-X11 218265	
Unlock			M22-XDP-S-X12 218266	
Unclamp			M22-XDP-S-X13 218267	
Clamp			M22-XDP-S-X14 218268	
Release			M22-XDP-S-X15 218269	
Liquid			M22-XDP-S-X16 218270	
Klaxon			M22-XDP-S-X17 218271	

WWW.TM2A.PT info@tm2a.pt

WWW.TM2A.PT info@tm2a.pt

Inscription or explanation	For use with	Color	Style: flush		Style: extended	
			Part no. Article no.	Std. pack	Part no. Article no.	Std. pack
Lenses for indicator lights						
≤ 5 characters: letter height 5 of mm > 5 characters: letter height of 3 mm						
-	M22-L-X M22-LC-X		M22-XL-W 216453	10 units	M22-XLH-W 216459	10 units
-			M22-XL-R 216454		M22-XLH-R 216460	
-			M22-XL-G 216455		M22-XLH-G 216461	
-			M22-XL-Y 216456		M22-XLH-Y 216462	
-			M22-XL-B 216457		M22-XLH-B 216463	
-			M22-XL-A 118740		M22-XLH-A 118741	
With customized Label Editor inscription → Notes		-	M22-XL-*-* 216458			
Zu			M22-XL-W-D2 218403			
Auf			M22-XL-W-D3 218404			
Ab			M22-XL-W-D4 218405			
Aus			M22-XL-R-D5 218406			
Ein			M22-XL-W-D6 218407			
Vorwärts			M22-XL-W-D15 218408			
Rückwärts			M22-XL-W-D16 218409			
Heben			M22-XL-W-D17 218410			
Senken			M22-XL-W-D18 218411			
STOP			M22-XL-R-GB0 218412			
STOP			M22-XL-W-GB0 218413			
START			M22-XL-G-GB1 218414			
START			M22-XL-W-GB1 218415			
CLOSE			M22-XL-W-GB2 218416			
UP			M22-XL-W-GB3 218417			
DOWN			M22-XL-W-GB4 218418			
TEST			M22-XL-W-GB9 218419			
OFF			M22-XL-R-GB5 218420			
ON			M22-XL-W-GB6 218421			
FORWARD			M22-XL-W-GB15 218422			

Notes

The following information must be added to the part no. when ordering:
 1. Wildcard Δ Color: -R (red), -G (green), -B (blue), -W (white), -Y (yellow), -S (black)
 2. Wildcard Δ Filename assigned by Label Editor → Page 74

Text size of 3 mm:
 Max. 8 characters in first line,
 10 characters in second line,
 8 characters in third line



Text size of 5 mm:
 Max. 5 characters per line



Inscription or explanation	For use with	Color, symbol	Part no. Article no.	Std. pack
Lenses for indicator lights				
≤ 5 characters: letter height 5 of mm > 5 characters: letter height of 3 mm				
REVERSE	M22-L-X M22-LC-X	●	M22-XL-W-GB16 218423	10 units
RAISE		●	M22-XL-W-GB17 218424	
LOWER		●	M22-XL-W-GB18 218425	
Stop		●	M22-XL-R-X0 218163	
Stop		○	M22-XL-W-X0 218164	
Start		●	M22-XL-G-X1 218384	
Start		⊥	M22-XL-W-X1 218385	
Start		⏸	M22-XL-G-X2 218386	
Start		⏸	M22-XL-W-X2 218387	
Increase		+	M22-XL-W-X4 218388	
Decrease		-	M22-XL-W-X5 218389	
Direction of movement		↑	M22-XL-W-X7 218390	
Direction of movement		↖	M22-XL-W-X8 218391	
Manual		✎	M22-XL-W-X9 218392	
Automatic		@	M22-XL-W-X10 218393	
Inch		⊕	M22-XL-W-X11 218394	
Unlock		🔓	M22-XL-W-X12 218395	
Unclamp		⊕	M22-XL-W-X13 218396	
Clamp		⊖	M22-XL-W-X14 218399	
Release		⚠	M22-XL-W-X15 218400	
Liquid		🚰	M22-XL-W-X16 218401	
Klaxon		📢	M22-XL-W-X17 218402	

WWW.TM2A.PT info@tm2a.pt

WWW.TM2A.PT info@tm2a.pt

1.6

RMQ-Titan pilot devices

Moeller series



























Button lenses for illuminated pushbutton actuators

1

Inscription or explanation	For use with	Color	Style: flush		Style: extended	
			Part no. Article no.	Std. pack	Part no. Article no.	Std. pack

Button lenses for illuminated pushbutton actuators

≤ 5 characters: letter height of 5 mm
> 5 characters: letter height of 3 mm

-	M22(S)-D-X M22(S)-DR-X		M22-XDL-W 216441	10 units	M22-XDLH-W 216447	10 units
-	M22-DG-X M30C-FDL-X M30C-FDRL-X		M22-XDL-R 216442		M22-XDLH-R 216448	
-			M22-XDL-G 216443		M22-XDLH-G 216449	
-			M22-XDL-Y 216444		M22-XDLH-Y 216450	
-			M22-XDL-B 216445		M22-XDLH-B 216451	
-			M22-XDL-A 167437		M22-XDLH-A 167438	
With customized Label Editor inscription → Notes		-	M22-XDL-*-* 216446		M22-XDLH-*-* 216452	
Zu			M22-XDL-W-D2 218316		M22-XDLH-W-D2 218359	
Auf			M22-XDL-W-D3 218317		M22-XDLH-W-D3 218360	
Ab			M22-XDL-W-D4 218318		M22-XDLH-W-D4 218361	
Aus			M22-XDL-R-D5 218319		M22-XDLH-R-D5 218362	
Ein			M22-XDL-W-D6 218320		M22-XDLH-W-D6 218363	
Entsperren			M22-XDL-B-D14 218321		M22-XDLH-B-D14 218364	
Vorwärts			M22-XDL-W-D15 218322		M22-XDLH-W-D15 218365	
Rückwärts			M22-XDL-W-D16 218323		M22-XDLH-W-D16 218366	
Heben			M22-XDL-W-D17 218324		M22-XDLH-W-D17 218367	
Senken			M22-XDL-W-D18 218325		M22-XDLH-W-D18 218368	
STOP			M22-XDL-R-GB0 218326		M22-XDLH-R-GB0 218369	
STOP			M22-XDL-W-GB0 218327		M22-XDLH-W-GB0 218370	
START			M22-XDL-G-GB1 218328		M22-XDLH-G-GB1 218371	
START			M22-XDL-W-GB1 218329		M22-XDLH-W-GB1 218372	
CLOSE			M22-XDL-W-GB2 218330		M22-XDLH-W-GB2 218373	
UP			M22-XDL-W-GB3 218331		M22-XDLH-W-GB3 218374	
DOWN			M22-XDL-W-GB4 218332		M22-XDLH-W-GB4 218375	
TEST			M22-XDL-W-GB9 218333		M22-XDLH-W-GB9 218376	
OFF			M22-XDL-R-GB5 218334		M22-XDLH-R-GB5 218377	
ON			M22-XDL-W-GB6 218335		M22-XDLH-W-GB6 218378	

Notes

The following information must be added to the part no. when ordering:
1. Wildcard * Δ Color: -R (red), -G (green), -B (blue), -W (white), -Y (yellow)
2. Wildcard * Δ Filename assigned by Label Editor → Page 74

Text size of 3 mm:

Max. 8 characters in first line,
10 characters in second line,
8 characters in third line



























Text size of 5 mm:

Max. 5 characters per line





Button lenses for illuminated pushbutton actuators

Inscription or explanation	For use with	Color, symbol	Style: flush		Style: extended	
			Part no. Article no.	Std. pack	Part no. Article no.	Std. pack
Button lenses for illuminated pushbutton actuators						
≤ 5 characters: letter height 5 of mm > 5 characters: letter height of 3 mm						
RESET	M22(S)-D-X M22(S)-DR-X		M22-XDL-B-GB14 218336	10 units	M22-XDLH-B-GB14 218379	10 units
FORWARD	M22-DG-X M30C-FDL-X M30C-FDRL-X		M22-XDL-W-GB15 218337		M22-XDLH-W-GB15 218380	
REVERSE			M22-XDL-W-GB16 218338		M22-XDLH-W-GB16 218381	
RAISE			M22-XDL-W-GB17 218339		M22-XDLH-W-GB17 218382	
LOWER			M22-XDL-W-GB18 218340		M22-XDLH-W-GB18 218383	
Stop			M22-XDL-R-X0 218159		M22-XDLH-R-X0 218161	
Stop			M22-XDL-W-X0 218160		M22-XDLH-W-X0 218162	
Start			M22-XDL-G-X1 218295		M22-XDLH-G-X1 218341	
Start			M22-XDL-W-X1 218296		M22-XDLH-W-X1 218342	
Start			M22-XDL-G-X2 218297		M22-XDLH-G-X2 218343	
Start			M22-XDL-W-X2 218301		M22-XDLH-W-X2 218344	
Increase			M22-XDL-W-X4 218302		M22-XDLH-W-X4 218345	
Decrease			M22-XDL-W-X5 218303		M22-XDLH-W-X5 218346	
Reset			M22-XDL-B-X6 218304		M22-XDLH-B-X6 218347	
Direction of movement			M22-XDL-W-X7 218305		M22-XDLH-W-X7 218348	
Direction of movement			M22-XDL-W-X8 218306		M22-XDLH-W-X8 218349	
Manual			M22-XDL-W-X9 218307		M22-XDLH-W-X9 218350	
Automatic			M22-XDL-W-X10 218308		M22-XDLH-W-X10 218351	
Inch			M22-XDL-W-X11 218309		M22-XDLH-W-X11 218352	
Unlock			M22-XDL-W-X12 218310		M22-XDLH-W-X12 218353	
Unclamp			M22-XDL-W-X13 218311		M22-XDLH-W-X13 218354	
Clamp			M22-XDL-W-X14 218312		M22-XDLH-W-X14 218355	
Release			M22-XDL-W-X15 218313		M22-XDLH-W-X15 218356	
Liquid			M22-XDL-W-X16 218314		M22-XDLH-W-X16 218357	
Klaxon			M22-XDL-W-X17 218315		M22-XDLH-W-X17 218358	

	Degree of protection	Mounting locations Qty.	Color	RAL number	Cable entry knockouts Number of M20 knockouts	Part no. Article no.	Std. pack
--	----------------------	-------------------------	-------	------------	--	-------------------------	-----------



Flush mounting plates

No add-on legend plates possible when using a vertical layout
Degree of protection only in conjunction with a suitable enclosure and correct mounting.

Aluminum with yellow paint finish for emergency stop button	IP65	1		RAL 1004	–	M22-EY1 216542	5 units
Aluminum Bright dip anodized, including M22-XE...	IP65	1		RAL 7035	–	M22-E1 216541	
		2			–	M22-E2 216543	
		3			–	M22-E3 216544	
		4			–	M22-E4 216545	1 unit
		5			–	M22-E5 216546	
	IP40	6			–	M22-E6 216547	

Shrouds

Light gray plastic
Degree of protection only in combination with M22-E... flush mounting plates

	IP55	1		RAL 7035	3	M22-H1 216548	1 unit
		2			4	M22-H2 216549	
		3			4	M22-H3 216550	
	IP40	4			4	M22-H4 216551	
		5			5	M22-H5 216552	
		6			6	M22-H6 216553	

Set of plaster keys









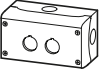

Comprising two plaster keys that can be used as mounting aids
For shroud plasterboard mounting

	–	–	–	–	–	M22-UPE 216554	1 unit
---	---	---	---	---	---	--------------------------	--------

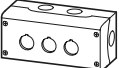
Mounting locations	Enclosure material	Cable entries	Degree of protection	Color	RAL number	Color	Part no. Article no.	Std. pack
--------------------	--------------------	---------------	----------------------	-------	------------	-------	----------------------	-----------

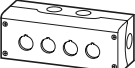
Surface mounting enclosures

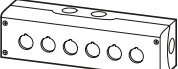
With stainless steel screws

	1	Plastic	At bottom: 2 x M16 At top: 1 x M20 On the sides: 2 x M20/M25 (one on each side)	IP67, IP69K		RAL 7035	Anthracite	M22-I1 216535	1 unit	
						RAL 1004	Anthracite	M22-IY1 216536		
						RAL 1004	Anthracite	M22-IY1-XPV60¹⁾ 167798		
		Stainless steel				–	–	–		M22-I1M/SS²⁾ 118455
		Metal					RAL 1004	–		M22-I1MGE-SAL 118456
	Metal		–	–	–	M22-I1M-SAL 118457				
	2	Plastic	At bottom: 2 x M20	IP67, IP69K		RAL 7035	Anthracite	M22-I2 216537		
		Stainless steel	At top: 1 x M20			–	–	–		M22-I2M/SS²⁾ 118458
		Metal	On the sides: 2 x M20/M25 (one on each side)			–	–	–		M22-I2M-SAL 118459
	3	Plastic	At bottom: 2 x M20	IP67, IP69K		RAL 7035	Anthracite	M22-I3 216538		
		Stainless steel	At top: 2 x M20			–	–	–		M22-I3M/SS²⁾ 118460
		Metal	On the sides: 2 x M20/M25 (one on each side)			–	–	–		M22-I3M-SAL 118461
	4	Plastic	At bottom: 2 x M20 At top: 2 x M20 On the sides: 2 x M20/M25 (one on each side)	IP67, IP69K		RAL 7035	Anthracite	M22-I4 216539		
	6	Plastic	At bottom: 2 x M20 At top: 2 x M20 On the sides: 2 x M20/M25 (one on each side)	IP66		RAL 7035	Anthracite	M22-I6 216540		



Notes

- ¹⁾ With additional cable entry in the front for M22-XPV60... illuminated ring
- ²⁾ With mounting tabs on the sides

Mounting locations	Cable entry knockouts		Color	RAL number	Degree of protection	Part no. Article no.	Std. pack
Qty.	Bottom	Sides					
	Number of M... entries	Number of M... entries					

Surface mounting enclosure

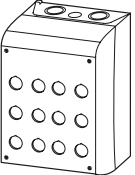
Including mounting plate for base mounting
Anthracite enclosure base

	12	2 x 32/25	2 x 20 4 x 32/25		RAL 7035	IP55	M22-I12 222688	1 unit

M20 connecting screw

For connecting any M22-I... surface mounting enclosures
Installed through M20 cable entry on the side







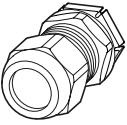

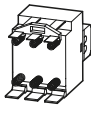
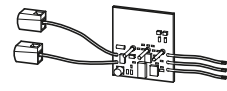
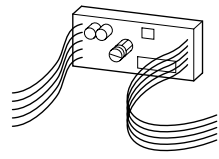
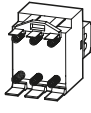
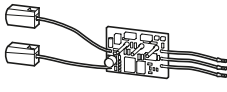
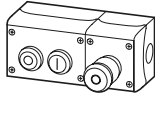

	–	–	–	–	–	IP67	M22-XI 229162	25 units
---	---	---	---	---	---	------	-------------------------	----------

M20 metric cable glands as defined in EN 50262

With lock nut and integrated strain relief
Polyamide, halogen-free
External diameter of cable: 6 - 13 mm

	–	–	–	–	–	IP68, IP69K	V-M20 206910	20 units
---	---	---	---	---	---	-------------	------------------------	----------

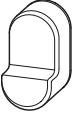
	Description	Part no. Article no.	Std. pack
AS-Interface connection for RMQ-Titan			
	For front mounting (RMQ-Titan) AS-Interface slave Adapter element for RMQ-Titan AS-Interface information: 2 input bits, 1 output bit Module enclosure for snap-fitting on the following contact and LED elements: Inputs for 2 contact elements: M22-K01 (N/C), M22-K10 (N/O) Output for 1 LED element: M22-LED-... Including AS-Interface connector as insulation piercing terminal	M22-ASI 231269	1 unit
	For base mounting (RMQ-Titan) Adapter element for RMQ-Titan AS-Interface information: 2 input bits, 1 output bit Inputs for 2 contacts Output for 1 LED element: M22-LED-...	M22-ASI-C 231271	1 unit
	For surface mounting enclosures (RMQ-Titan) External connections: 4 inputs/4 outputs (for RMQ contact and lamp socket elements.) RMQ-Titan surface mounting enclosures: M22-I3, M22-I4, M22-I6	RMQ-M1C-ASI 032314	1 unit
Emergency stop interfaces for AS-Interface for safety monitor			
	For front mounting AS-Interface slave Adapter element for RMQ-Titan AS-Interface information: 1 dual-channel input, 1 output Module enclosure for snap-fitting on the following contact and LED elements: Inputs for 2 contact elements: M22-K01 (N/C) Output for 1 LED element: M22-LED-... Including AS-Interface connector as insulation piercing terminal	M22-ASI-S 231270	1 unit
	For base mounting AS-Interface slave Adapter element for RMQ-Titan or FAK AS-Interface information: 1 dual-channel input, 1 output for the following RMQ-Titan contact and LED elements: Inputs for 2 contact elements: M22-K01 or M22-K01 (N/C) Output for 1 LED element: M22-LED-...	M22-ASI-CS 231272	1 unit
	AS-Interface complete device M22-I2 and M22-I2Y surface mounting enclosures M22-PVL emergency stop button and ON/OFF pushbutton; ON illuminated 1 M22-AS-Interface-CS and 1 M22-AS-Interface-C 1 M12A connector Address for M22-PVL → 0; ON/OFF 1 A	M22-I1/2-M1-ASI 107405	1 unit

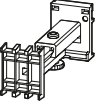
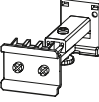
	For use with	Color	Part no. Article no.	Std. pack
	Gold bezel (24 Carat) Bezel not available individually: Can be ordered only through Eaton sales office as M22-COMBINATION-* (customized complete devices)			
	-	-	M22-FR-AU 274150	1 unit
	Blanking plugs Round design, IP67, IP69K For sealing spare mounting locations			
	M22		M22-B 216388	50 units
	M22		M22-B-GVP 216389	250 units
	M22		M22S-B 216390	50 units
	M22		M22S-B-GVP 216391	250 units
	M30		M30C-FB 187028	1 unit
	Pushbutton diaphragms for IP67, IP69K, silicone Transparent diaphragms for harsh environmental conditions and use in the food industry. Do not use with legend holder M22S-ST, as the degree of protection will not be guaranteed			
	M22(S)-D(R)-... M22(S)-DL-... M22(S)-DRL-... M22(S)-L(C)-...	-	M22-T-D 216395	10 units
	M22(S)-DDL...	-	M22-T-DD 216396	10 units
	Protective diaphragm, silicone Prevents the ingress of dirt and dust into the key opening.			
	M22-WS...	-	M22-XWS 231275	5 units
	Telescopic clips For adjusting the depth of rear mounting devices in CI enclosures and cabinets with mounting depths of 115 to 155 mm. Continuously adjustable; screw and snap fitting (IEC/EN 60715 DIN-rail); maximum of 10 M22-TC units permissible per enclosure, of which 5 must have pushbuttons with maintained action, Do not use in conjunction with emergency stop buttons.			
	3 contact/LED elements, base mounting configuration, including centering adapter	-	M22-TC 216398	10 units
	With IEC/EN 60715 DIN-rail, width of 44 mm For mounting EASY, FAZ, PKZ, DIL, etc. weighing ≤ 0.3 kg easy200, easy500, easy700, easy800, MFD-CP8, EC4P Continuously adjustable over scales of 75 - 115 mm	-	M22-TA 226161	1 unit







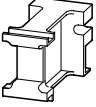

1.6

RMQ-Titan pilot devices

Moeller series

Accessories

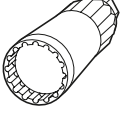
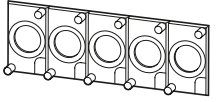
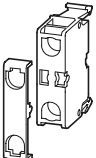
1

	For use with	Part no. Article no.	Std. pack
	Extension Telescopic clip for a mounting depth of up to 205 mm	M22-TCV 225527	5 units
	IVS top-hat rail adapter IEC/EN 60715 DIN-rail for front mounting	M22-IVS 216400	1 unit
	Plunger bridge For actuating the middle contact element of the M22-W...3 non-illuminated 3-position selector switch → Page 74	M22-XW 216405	10 units
	Guard ring To protect against accidental actuation, IP66 For pushbuttons and selector switches (add-on legend plates cannot be used)	M22-XGWK 231274	5 units
	Threaded rings M22 x 1.5 mm		
	6.0 mm thick	M22-GR 216401	50 units
	4.8 mm thick	M22-GR7 288852	50 units
	6.0 mm thick	M22-GR-GVP 216404	500 units
	30/22.3 mm set of adapter rings Black, consisting of adapter ring and fixing nut, IP67, IP69K For installing 22.3 mm diameter devices in 30.5 mm diameter holes The degree of protection is determined by the front element	M22S-R30 216408	10 units
	Mounting ring tool For threaded ring; can be used with cordless screwdriver.	M22-MS 216402	5 units
	Fixing plate M22-H... on M22-E... flush mounting plate for 5 mounting locations	M22-XE5 218945	1 unit
	Dust cover For M22-K... contacts (front mounting)	M22-XKDP 100647	50 units
	Dust cover and mechanical mount For M22... 5 x M20 knockouts		
	Max. 3 contacts	M22-ADC 106523	1 unit
	Max. 4 contacts	M22-ADC4 106524	
	Mechanical mount	M22-XADC 107918	
	Gasket For add-on legend plates used on uneven surfaces	M22-XZD 134826	50 units

Version	Lifespan at $t_a = +25^\circ\text{C}$ $t_{\text{average}} \text{ (AC)}$ h	Color	Part no. Article no.	Std. pack
---------	---	-------	-------------------------	-----------



BA 9s incandescent lamps for compact indicator lights

High-quality versions from select manufacturers

110 - 130 V/2.4 W	2000	–	A22-GL130 261361	100 units
24 V/2.0 W	5000	–	A22-GL24 261360	100 units



BA 9s single-chip LEDs for compact indicator lights

For AC and DC (positive pole connected to X1), protected against polarity reversal, integral suppressor circuit up to 1500 V

12 - 30 V AC/DC/15 mA	100000		A22-LED-W 261362	10 units
12 - 30 V AC/DC/15 mA	100000		A22-LED-R 261364	
12 - 30 V AC/DC/15 mA	100000		A22-LED-G 261363	
12 - 30 V AC/DC/15 mA	100000		A22-LED-Y 261365	

Cable length	Terminal diagram / Contact assignment	Silver bezel Part no. Article no.	Black bezel Part no. Article no.	Std. pack
m				

M22 USB and RJ45 panel mount connectors

Front mounting
IP65 (with closed cover), IP20 (with plug connected)



USB 3.0 socket, Type A

–

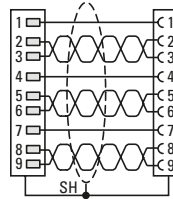

M22-USB 147539	M22S-USB 147541	1 unit
--------------------------	---------------------------	--------

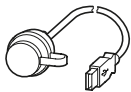

Prefabricated cable with permanently connected USB 3.0 Type A plug

0.6

1.5

M22-USB-SA 107412	M22S-USB-SA 147535	1 unit
M22-USB-SA-150 147543	M22S-USB-SA-150 147545	



RJ45 socket, 8/8, Cat 5e

–

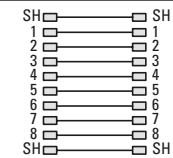

M22-RJ45-SA 107413	M22S-RJ45-SA 147537	1 unit
------------------------------	-------------------------------	--------

M30C USB and RJ45 panel mount connectors (Flat Front)

Front mounting
IP20 (with plug connected)

Metal bezel



With permanently connected USB 3.0 Type A plug

–

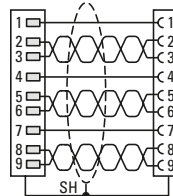

M30C-FUSB 187082		1 unit
----------------------------	--	--------

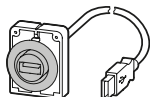

Prefabricated cable with permanently connected USB 3.0 e A plug

0.3

0.6

1.5

M30C-FUSB-30 187083		1 unit
M30C-FUSB-60 187084		
M30C-FUSB-150 187085		



RJ45 socket, 8/8, Cat 5e

–

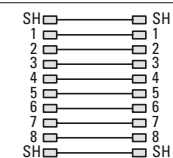

M30C-FRJ45 187086		1 unit
-----------------------------	--	--------

1.6

RMQ-Titan pilot devices

Moeller series

Accessories

1



For use with	Color	Part no. Article no.	Std. pack	Notes
Pushbuttons				
For enclosed overload relays Mounting hole diameter: 22.3 mm				
ZW7... ZB12		M22-DZ-B 254833	10 units	Blue button plate
ZB32 ZB65 ZB150		M22-DZ-B-GB14 254834		Blue button plate Inscription: RESET
	–	M22-DZ-X 254835		Without button plate, add button plate



Bulb extractor				
For M22-LC(H)... compact indicator light				
A22-GL... A22-LED...	–	M22-LG 216403	5 units	–

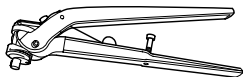

Notching tool				
Punching tool used to produce the cutout for the anti-rotation tab as defined in IEC/EN 60947-5-1 St 37 sheet steel: max. 3 mm thickness Stainless steel: max. 1.5 mm thickness				
	–	BA/C-NZ-22 028144	1 unit	



Customized complete devices				
To order, use form F0315 → Data sheet in online catalog				
–	–	M22-COMBINATION 2010741	1 unit	–

Engineering

M22...SMC10

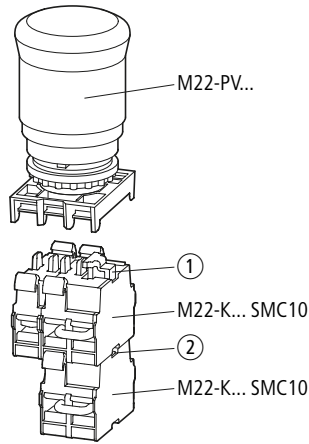
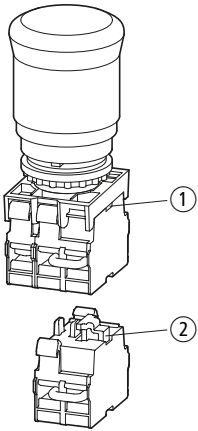

- ① The self-monitoring contact mechanically monitors the connection on the M22-PV...
- ② The self-monitoring contact mechanically monitors the connection on the M22-K...SMC10 safety contact above it; but not the connection on the M22-PV...

M22-K01SMC10
M22-KC01SMC10

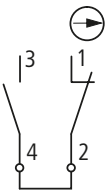

M22-K02SMC10
M22-KC02SMC10

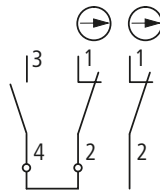

When the self-monitoring contact is mounted correctly, the N/O contact is closed.
The emergency stop/controlled stop circuit will be activated by means of an N/C and N/O connected in series if:

- The emergency stop/controlled stop button is pressed OR
- The self-monitoring contact is mechanically separated from the pushbutton

Momentary/maintained configuration, plunger bridges, Label Editor, Pushbutton Configurator

1

Changing between maintained/momentary action and changing the key withdraw on selector switches with 3 positions

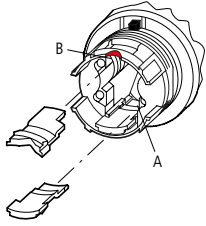

	I		O	II	
	A	B		A	B
60° ↘ 60°	-	✓	✓	-	✓
50° ↘ 50°	✓	x	✓	✓	x
60° ↘ 50°	-	✓	✓	✓	x
50° ↘ 60°	✓	x	✓	-	✓
40° ↘ 40°	✓	x	✓	✓	x
60° ↘ 40°	-	✓	✓	✓	x
50° ↘ 40°	✓	x	✓	✓	x
40° ↘ 60°	✓	x	✓	-	✓
40° ↘ 50°	✓	x	✓	✓	x

✓ = Key is withdrawable
x = Key is not withdrawable

Configuration adapters

- 2x M22-XC-Y → Page 30
- 1x M22-XC-R → Page 30
- 1x

Ordering examples:

- M22-XST insert label for M22S-ST-X label mount with custom inscription
Basic part no.: M22-XST-*
* = Filename assigned by Label Editor
Please order: 1 x M22-XST-RMQ_Titan_xxxxxx.zip
- Green button plate with custom inscription
Basic part no.: M22-XDH-*
1st * = Color ("G" for "green" in this case); 2nd * = Filename assigned by Label Editor
Please order: 1 x M22-XDH-G-RMQ_Titan_xxxxx.zip
- Double actuator pushbutton with white button plates and custom symbols
Basic part no.: M22-DDL-*-*-*
1st * = Color ("W" for "white" in this case); 2nd and 3rd * = Filename assigned by Label Editor; must be entered twice
Please order: 1 x M22-DDL-W-RMQ_Titan_xxxxx.zip-RMQ_Titan_xxxxx.zip
- Key-operated button, 2 positions, individual lock mechanism number MS1, custom symbol
Basic part no.: M22-WRS*-MS*-*
WRS*: * = Number of positions
MS*: * = Individual lock mechanism number
-*-* = Filename assigned by Label Editor
Please order: 1 x M22-WRS2-MS1-RMQ_Titan_xxxxxx.zip

Changing between maintained/momentary action and changing the key withdraw on selector switches with 2 positions

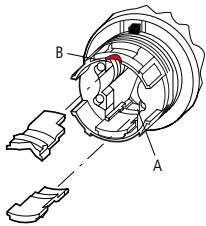

	O	I
		B
↘ 60°	✓	✓
↘ 50°	✓	✓
↘ 40°	✓	✓

✓ = Key is withdrawable
x = Key is not withdrawable

Configuration adapters

- 2x M22-XC-Y → Page 30
- 1x M22-XC-R → Page 30

Plunger bridge for the middle contact on M22(S)-W...3-... 3-position selector switches

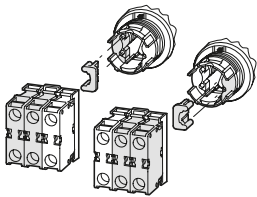

Customized inscription for devices using the Label Editor function in the Pushbutton Configurator

To add a custom inscription to your device, simply follow the four steps below:

- Open the Pushbutton Configurator by visiting: www.eaton.eu/config/rmq
- Create your label template (the software features menus to guide you through the process)
- Send the label template to the factory by e-mail. The program will automatically set the e-mail address based on the selected product. When you send your template, the Pushbutton Configurator will automatically assign it a filename such as "RMQ_Titan_12345.zip". This filename is part of the article no. that needs to be used when ordering (see ordering examples)
- Send the order to the Eaton sales office or the appropriate electrical wholesale distributor

LED series resistor elements

M22-XLED

Surface mounting enclosure

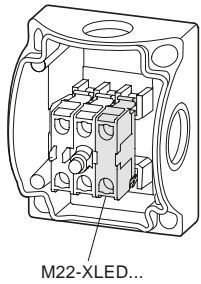

Flush mounting at the rear

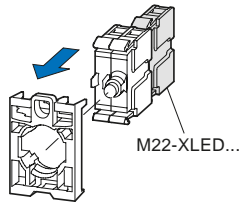

Flush mounting at the side

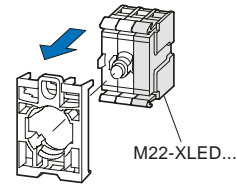

LED resistor element

M22-XLED60/M22-XLED220

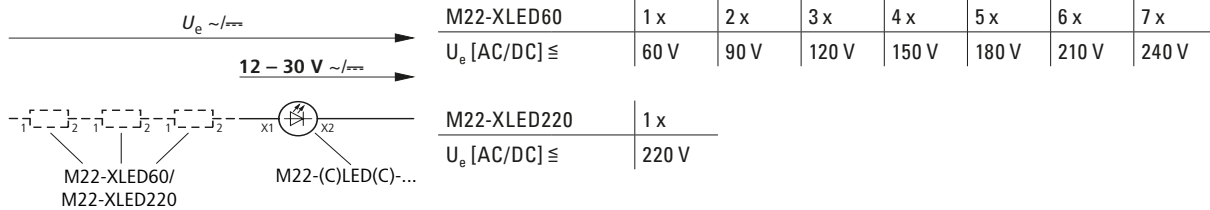

LED test element

M22-XLED-T

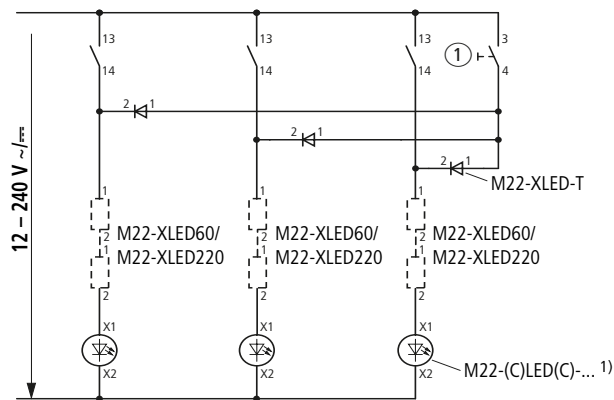

① Test button
 1) Only for 12 - 30 V elements

M22-XLED230-T

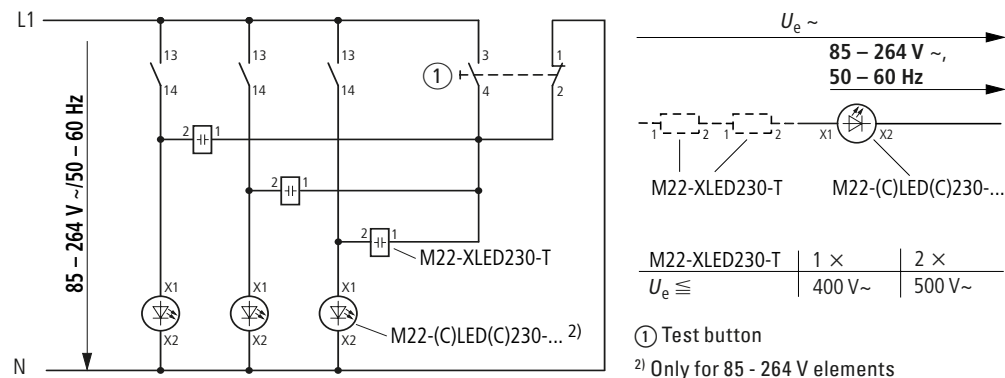

① Test button
 2) Only for 85 - 264 V elements

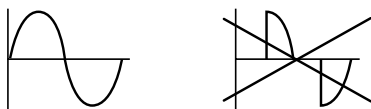

Technical data

				Contact elements		Double contact elements	LED elements		
				M22-(C)K...	M22-FK...	M22-CK20/02/11	M22(C)-LED...	M22-FLED...	
General									
Standards				IEC/EN 60947-5-1		IEC/EN 60947-5-1	IEC/EN 60947-5-1		
Lifespan, mechanical	Operations	x 10 ⁶	5	1	–	–	–	–	
Operating frequency	Operations/h		≤ 3600	≤ 3600	≤ 3600	–	–	–	
Operating force	N		5	4.5	10	–	–	–	
Operating torque (screw terminals)	Nm		0.8	–	–	0.8	–	–	
Degree of protection (IEC/EN 60529)				IP20	IP20	IP20	IP20	IP20	
Climatic proofing				Damp heat, constant as defined in IEC 60068-2-78 Damp heat, cyclic as defined in IEC 60068-2-30					
Ambient air temperature, open	°C		-25 - +70	-25 - +70	-25 - +70	-25 - +70	-25 - +70	-25 - +70	
Mounting position				Any	Any	Any	Any	Any	
Mechanical shock resistance as defined in IEC 60068-2-27 Shock duration: 11 ms, half sine shock				g	30	50	30	30	50
Terminal capacities									
Solid	mm ²		0.75 - 2.5	2 x 1 (0.2 - 1.5) 2 x 1 (0.75 - 1.5) ¹⁾	0.5 - 1.5	0.75 - 2.5	1 x 1 (0.2 - 1.5) 1 x 1 (0.75 - 1.5) ¹⁾		
Stranded	mm ²		0.5 - 2.5	–	0.5 - 1.5	0.5 - 2.5	1 x 1 (0.2 - 1.5)		
Flexible with ferrule	mm ²		0.5 - 1.5	2 x 1 (0.25 - 1) ²⁾	0.5 - 1.5	–	1 x 1 (0.25 - 1) ²⁾		
Contacts									
Rated impulse withstand voltage	U _{imp}	V AC	6000	4000	–	6000	4000	–	
Rated insulation voltage	U _i	V	500	250	–	500	250	–	
Overvoltage category/degree of pollution				III/3	III/3	III/3	III/3	III/3	
Control circuit reliability									
At 24 V DC/5 mA	H _F	Failure rate	< 10 ⁻⁷ (i.e., one failure every 10 ⁷ operations)	–	–	–	–	–	
At 5 V DC/1 mA	H _F	Failure rate	< 5 x 10 ⁻⁶ (i.e., one failure every 5 x 10 ⁶ operations)	–	–	–	–	–	
Max. short-circuit protective device									
Fuseless		Part no.	PKZM0–10/FAZ-B6/1	FAZ-B4	–	–	–	–	
Fuse	gG/gL	A	10	4	–	–	–	–	
Switching capacity									
Rated operational current									
AC-15	24 V	I _e	A	–	4	–	–	–	
	60 V	I _e	A	–	4	–	–	–	
	100 V	I _e	A	–	2	–	–	–	
	115 V	I _e	A	6	–	–	–	–	
	230 V	I _e	A	6	1.5	–	–	–	
	400 V	I _e	A	4	–	–	–	–	
	500 V	I _e	A	2	–	–	–	–	
DC-13	24 V	I _e	A	3	1.5	–	–	–	
	42 V	I _e	A	1.7	–	–	–	–	
	60 V	I _e	A	1.2	0.8	–	–	–	
	110 V	I _e	A	0.6 (M22-CK...: 0.8)	0.4	–	–	–	
	220 V	I _e	A	0.3	0.2	–	–	–	
Lifespan, electrical									
AC-15	230 V/0.5 A	Operations	x 10 ⁶	1.6	–	–	–	–	
	230 V/1.0 A	Operations	x 10 ⁶	1	–	–	–	–	
	230 V/3.0 A	Operations	x 10 ⁶	0.7	–	–	–	–	
DC-13	12 V/2.8 A	Operations	x 10 ⁶	1.2	–	–	–	–	

Notes

¹⁾ Can be plugged without tools

²⁾ Use WAGO Variocrimp 4 crimping tool; please enquire for others

	AS-Interface connection for RMQ-Titan		Adapter element for RMQ-Titan	
		RMQ-M1C-ASI	M22-ASI	M22-ASI-C
General				
Standards		EN 50081-1 EN 50082-1	IEC/EN 60947, DIN EN 50 295	IEC/EN 60947, DIN EN 50 295
Radio interference suppression		EN 55011, EN 55022	EN 55011, EN 55022	EN 55011, EN 55022
Limit value class		A	–	–
Degree of protection		IP20	IP20	IP00
Climatic proofing		Damp heat, constant as defined in IEC 60068-2-78; Damp heat, cyclic as defined in IEC 60068-2-30		
Ambient temperature, open	°C	+25 - +55	+25 - +55	+25 - +55
Mechanical shock resistance for a shock duration of 11 ms	g	> 30	> 30	> 30
Vibrations as per IEC 60068-2-27 (amplitude: 1 mm)	Hz	10 - 55	–	–
Dimensions (W x H x D)	mm	92 x 46 x 30	–	–
Weight	kg	0.1	–	–
Mounting		RMQ-Titan front mounting	RMQ-Titan front mounting	RMQ-Titan base mounting
Mounting position		Any	Any	Any
Power supply				
Rated operating voltage as per AS-Interface specifications	V DC	26.5 - 31.6	26.5 - 31.6	26.5 - 31.6
Terminal type		–	Yellow plug-in terminal as insulation piercing terminal	2 cables on PCB
Power supply		Completely from the AS-Interface cable	Completely from the AS-Interface cable	Completely from the AS-Interface cable
Address setting		Via AS-Interface cable connection	Via AS-Interface cable connection	Via AS-Interface cable connection
Total AS-Interface current draw	mA	–	≤ 40	≤ 40
AS-Interface		Protected against polarity reversal	Protected against polarity reversal	Protected against polarity reversal
Rated operational current at full load	mA	120	–	–
Rated operational current when idle (no I, 0 set)	mA	Normally 30	–	–
LED status indicators		AS-Interface voltage: green LED	AS-Interface POWER line: green LED on element rear AS-Interface ERROR, AS-Interface master failure: red LED on element rear	AS-Interface POWER line: green LED on PCB AS-Interface ERROR, AS-Interface master failure: red LED on PCB
Inputs				
Inputs; short-circuit proof	Qty.	4 (1 internal + 3 external)	2 (normally 22 V/5 mA)	2 (normally 22 V/5 mA)
Voltage range	V DC	24 - 30	–	–
Operating current per input	mA	Normally 3.5	–	–
Switching level, HIGH signal	V	≥ 15	–	–
LOW signal	mA	–	–	–
Length of connecting cables	cm	≤ 200	–	–
Outputs				
Outputs, short-circuit proof	Qty.	4 (1 internal + 3 external)	1 (normally 19 V/8 mA)	1 (normally 19 V/8 mA)
Voltage range	V DC	24 V DC (+10/-15%)	–	–
Max. current carrying capacity				
All outputs		–	–	–
Sum 3 external outputs		60	–	–
Length of connecting cables	cm	≤ 200	–	–
Profile		S-7.0	S-3.A.E	S-3.A.E
Specification		2.0	2.1	2.1
Addresses	Qty.	31	62	62

	M22-ASI-S	M22-ASI-CS
Emergency stop connections		
AS-Interface cable connection	Yellow plug-in terminal as insulation piercing terminal	2 cables on PCB
Power supply	Completely from the AS-Interface, cable, 26.5 - 31.6 V DC	Completely from the AS-Interface, cable, 26.5 - 31.6 V DC
Mounting	RMQ-Titan front mounting	RMQ-Titan base mounting
Address setting	Via AS-Interface cable	Via AS-Interface cable
Max. total current	mA 45	45
Ambient air temperature	°C -25 - +55	-25 - +55
Mechanical shock resistance	30 g/11 ms as defined in IEC 60068-2-27	30 g/11 ms as defined in IEC 60068-2-27
Degree of protection	IP20	IP00
Climatic proofing	Damp heat, constant as defined in IEC 60068-2-78 Damp heat, cyclic as defined in IEC 60068-2-30	Damp heat, constant as defined in IEC 60068-2-78 Damp heat, cyclic as defined in IEC 60068-2-30
Mounting position	Any	Any
Standards	EN 50178 EN 50295	EN 50178 EN 50295
Inputs	Dual-channel input (22 V/5 mA) (modulated with code sequence) (2 RMQ-Titan M22-K01 N/C contact elements)	Dual-channel input (22 V/5 mA) (modulated with code sequence) (2 RMQ-Titan M22-K01 N/C contact elements)
Outputs	1 output, normally 19 V/8 mA, short-circuit proof	1 output, normally 19 V/8 mA, short-circuit proof
Status indicators		
AS-Interface POWER cable	Green LED on rear	Green LED on rear
AS-Interface ERROR, AS-Interface master failure	Red LED on rear	Red LED on rear
Profile	S-7.B.E	S-7.B.E

UL File No. 29184	Pilot duty	General use	Wire gauges
Rating data for UL/CSA-listed models			
RMQ16 contact elements			
E 10	C 300, Q 300		Cu cable Min. AWG 18, Max. AWG 14
E01	C 300, R 300		
RMQ-Titan contact elements			
M22-K...	A 600, Q 300,	10 A - 600 V AC	2 x 14 ... 18 AWG
M22-CK...	> 300 V AC same polarity	1 A - 250 V DC	2 x 12 ... 22 AWG
RMQ-Titan LED elements			
M22-LED...			2 x 14 ... 18 AWG
M22-CLED...			2 x 12 ... 22 AWG
M22-LC(H)			2 x 16 ... 20 AWG
M22-AMC			2 x 16 ... 20 AWG

		UL 508 requirements UL 4X	NEMA recommendation NEMA 13
RMQ-Titan degrees of protection			
All front elements	M22(S)-...	✓	✓
Add-on legend plates	M22S-ST...	✓	✓
Emergency stop legend plates	M22-XAK...	✓	✓
	M22-XZK...	✓	✓
	M22-XBK...	✓	✓
	M22-XYK...	✓	✓
Foot and palm switches	FAK-...	✓	✓

General				
Standards		IEC/EN 61131-2 EN 50178		
Dimensions (W x H x D)	mm	12 x 42 x 39	12 x 45 x 37	10 x 42 x 45
Weight	g	10	10	10
Mounting position		Any		
Ambient mechanical conditions				
Degree of protection (IEC/EN 60529)		IP20	IP20	IP20
Vibrations (IEC/EN 61131-2:2008)				
Constant amplitude of 3.5 mm	Hz	5 - 8.4	5 - 8.4	5 - 8.4
Constant acceleration of 1 g	Hz	8.4 - 150	8.4 - 150	8.4 - 150
Mechanical shock resistance (IEC/EN 60068-2-27), half sine shock: 15 g/11 ms	Shocks	9	9	9
Drop (IEC/EN 60068-2-31)	Drop height	mm	50	50
Free fall, packaged (IEC/EN 60068-2-32)		m	0.3	0.3
Electromagnetic compatibility (EMC)				
Overvoltage category		Not applicable		
Pollution degree		2	2	2
Electrostatic discharge (IEC/EN 61131-2:2008)				
Air discharge (level 3)	kV	8	8	8
Contact discharge (level 2)	kV	4	4	4
Electromagnetic fields (IEC/EN 61131-2:2008)				
80 - 1000 MHz	V/m	10	10	10
1.4 - 2 GHz	V/m	3	3	3
2 - 2.7 GHz	V/m	1	1	1
Radio interference suppression (SmartWire-DT)		EN 55011 Class A		
Burst (IEC/EN 61131-2:2008, level 3)				
Supply cables	kV	2	2	2
SmartWire-DT cables	kV	1	1	1
Radiated RFI (IEC/EN 61131-2:2008, level 3)	V	10	10	10
Ambient climatic conditions				
Operating ambient temperature (IEC 60068-2)	°C	-30 - +55	-30 - +55	-30 - +55
Condensation		Must be prevented with suitable measures		
Storage	°C	-40 - 80	-40 - 80	-40 - 80
Relative humidity, non-condensing (IEC/EN 60068-2-30)	%	9 - 95	9 - 95	9 - 95
SmartWire-DT network				
Module type		SmartWire-DT module (slave)		
Baud rate setting		Automatic		
SmartWire-DT status LED		Green		
Connections		Pin header, 8-pin		
Plug connector		SWD4-8SF2-5	M22-SWD-I...LP	SWD4-8SF2-5
Number of insertion cycles		50	50	50
Function element				
Contacts		1 changeover contact	1 changeover contact	–
Lifespan, mechanical/electrical	Operations	1 x 10 ⁶	1 x 10 ⁶	–
LED indicator		No	No	Yes
Diagnostics		Yes	Yes	No
Mounting		Front mounting	Base mounting	Front mounting

M22-SWD-LEDC-...	M22-SWD-K11LED-...	M22-SWD-K11LEDC-...	M22-SWD-K22	M22-SWD-KC22	M22-SWD-K22LED-...	M22-SWD-K22LEDC-...
IEC/EN 61131-2 EN 50178	IEC/EN 61131-2 EN 50178	IEC/EN 61131-2 EN 50178	IEC/EN 61131-2 EN 50178	IEC/EN 61131-2 EN 50178	IEC/EN 61131-2 EN 50178	IEC/EN 61131-2 EN 50178
10 x 45 x 42	12 x 42 x 45	12 x 45 x 42	17 x 42 x 39	17 x 45 x 37	17 x 42 x 45	17 x 45 x 42
10	10	10	14	14	14	14
Any						
IP20	IP20	IP20	IP20	IP20	IP20	IP20
5 - 8.4	5 - 8.4	5 - 8.4	5 - 8.4	5 - 8.4	5 - 8.4	5 - 8.4
8.4 - 150	8.4 - 150	8.4 - 150	8.4 - 150	8.4 - 150	8.4 - 150	8.4 - 150
9	9	9	9	9	9	9
50	50	50	50	50	50	50
0.3	0.3	0.3	0.3	0.3	0.3	0.3
Not applicable						
2	2	2	2	2	2	2
8	8	8	8	8	8	8
4	4	4	4	4	4	4
10	10	10	10	10	10	10
3	3	3	3	3	3	3
1	1	1	1	1	1	1
EN 55011 Class A						
2	2	2	2	2	2	2
1	1	1	1	1	1	1
10	10	10	10	10	10	10
-30 - +55	-30 - +55	-30 - +55	-30 - +55	-30 - +55	-30 - +55	-30 - +55
Must be prevented with suitable measures						
-40 - 80	-40 - 80	-40 - 80	-40 - 80	-40 - 80	-40 - 80	-40 - 80
9 - 95	9 - 95	9 - 95	5 - 95	5 - 95	5 - 95	5 - 95
SmartWire-DT module (slave)						
Automatic						
Green						
Pin header, 8-pin						
M22-SWD-I...LP	SWD4-8SF2-5	M22-SWD-I...LP	SWD4-8SF2-5	M22-SWD-I...LP	SWD4-8SF2-5	M22-SWD-I...LP
50	50	50	50	50	50	50
-	1 changeover contact	1 changeover contact	2 changeover contacts	2 changeover contacts	2 changeover contacts	2 changeover contacts
-	1 x 10 ⁶	1 x 10 ⁶	1 x 10 ⁶	1 x 10 ⁶	1 x 10 ⁶	1 x 10 ⁶
Yes	Yes	Yes	No	No	Yes	Yes
No	Yes	Yes	Yes	Yes	Yes	Yes
Base mounting	Front mounting	Base mounting	Front mounting	Base mounting	Front mounting	Base mounting

		SWD4-RC8-10	SWD4-8SF2-5	SWD4-8SFF2-5
General				
Standards		IEC/EN 61131-2 EN 50178		
Dimensions (W x H x D)	mm	48.5 x 34.5 x 10	15 x 36.5 x 17.5	48.5 x 34.5 x 10
Weight	g	10	5.5	4.5
Mounting position		Any	Any	Any
Ambient mechanical conditions				
Degree of protection (IEC/EN 60529)		IP20	IP20	IP20
Vibrations (IEC/EN 61131-2:2008)				
Constant amplitude of 3.5 mm	Hz	5 - 8.4	5 - 8.4	5 - 8.4
Constant acceleration of 1 g	Hz	8.4 - 150	8.4 - 150	8.4 - 150
Mechanical shock resistance (IEC/EN 60068-2-27) half sine shock: 15 g/11 ms	Shocks	9	9	9
Drop (IEC/EN 60068-2-31)	Drop height	mm	50	–
Free fall, packaged (IEC/EN 60068-2-32)		m	0.3	–
Electromagnetic compatibility (EMC)				
Overvoltage category		II	–	–
Pollution degree		2	–	–
Electrostatic discharge (IEC/EN 61131-2:2008)				
Air discharge (level 3)	kV	8	–	8
Contact discharge (level 2)	kV	4	–	4
Electromagnetic fields (IEC/EN 61131-2:2008)				
80 - 1000 MHz	V/m	10	–	–
1.4 - 2 GHz	V/m	3	–	–
2 - 2.7 GHz	V/m	1	–	–
Radio interference suppression (SmartWire-DT)		EN 55011 Class A	–	–
Burst (IEC/EN 61131-2:2008, level 3)				
SmartWire-DT cables	kV	1	–	–
Radiated RFI (IEC/EN 61131-2:2008, level 3)	V	10	–	–
Ambient climatic conditions				
Operating ambient temperature (IEC 60068-2)	°C	-25 - +55	-25 - +55	-25 - +55
Condensation		Must be prevented with suitable measures		
Storage	°C	-40 - 70	-40 - 70	-40 - 70
Relative humidity, non-condensing (IEC/EN 60068-2-30)	%	5 - 95	5 - 95	5 - 95
Connection options				
SWD In		Pin header, 8-pin	Male connector	Pin header, 8-pin
Number of insertion cycles		≥ 200	1	≥ 200
SWD Out		–	Socket, 8-pin	Pin header, 8-pin
Number of insertion cycles		–	≥ 200	≥ 200

SWD4-SF8-20	SWD4-SM8-20	SWD4-8FRF-10	SWD4-SFL8-20	SWD4-SML8-20
IEC/EN 61131-2 EN 50178				
24 x 26 x 162	24 x 26 x 170	35 x 90 x 35	35 x 83 x 40	35 x 83 x 46
20	22.5	42	50	50
Any	Any	Any	Any	Any
IP67	IP67	IP20	IP67	IP67
		5 - 8.4	5 - 8.4	5 - 8.4
		8.4 - 150	8.4 - 150	8.4 - 150
-	-	9	9	9
-	-	-	-	-
-	-	-	-	-
-	-	-	-	-
-	-	-	-	-
-	-	8	8	8
-	-	4	4	4
-	-	-	10	10
-	-	-	3	3
-	-	-	1	1
-	-	-	-	-
-	-	-	-	-
-	-	-	10	10
-25 - +55	-25 - +55	-25 - +55	-25 - +55	-25 - +55
Must be prevented with suitable measures				
-40 - 70	-40 - 70	-40 - 70	-40 - 70	-40 - 70
5 - 95	5 - 95	5 - 95	5 - 95	5 - 95
-	Plug, 8-pin	Pin header, 8-pin	Pin header, 8-pin	Plug, 8-pin
-	≥ 500	≥ 200	≥ 200	≥ 500
Socket, 8-pin	-	Push-in terminals	Socket, 8-pin	Pin header, 8-pin
≥ 500	-	-	≥ 500	≥ 200

WWW.TM2A.PT info@tm2a.pt

WWW.TM2A.PT info@tm2a.pt

Dimensions

Pilot device elements

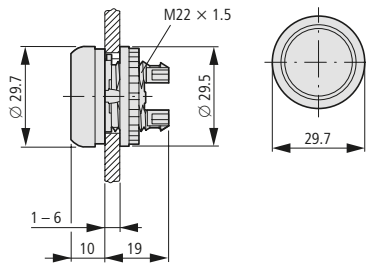

RMQ-Titan pushbuttons

M22...-D...

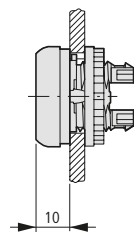

M22...-DH...

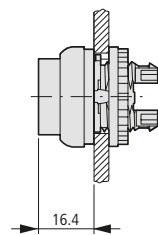

M22-DG(L)...

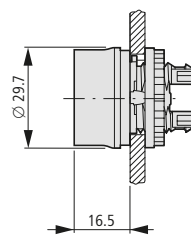

M22...-DD...

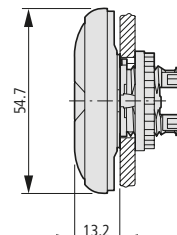

M22-D pushbuttons with base mounting

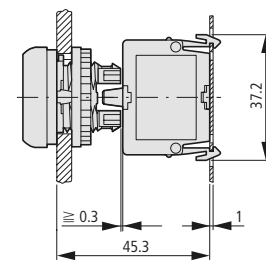

RMQ-Titan selector switches

M22-W...

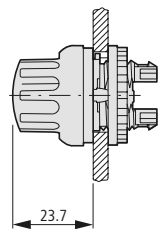

M22...-W(K)L...

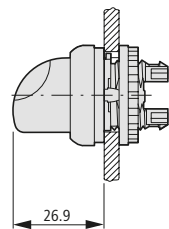

RMQ-Titan key-operated buttons

Individual lock mechanism

M22...-W(R)S...

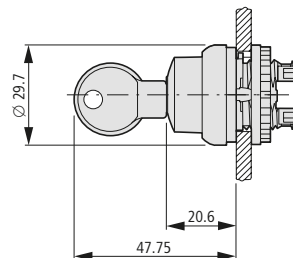

Master key systems

M22...-W...S-SA...

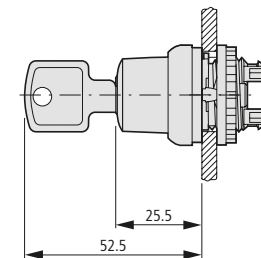

RMQ-Titan indicator lights

M22-LH-...

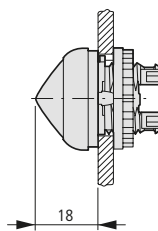

M22-L...

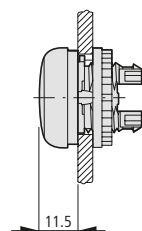

RMQ-Titan illuminated pushbutton actuators

M22...-DL-...

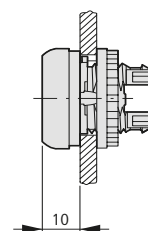

M22...-DLH...

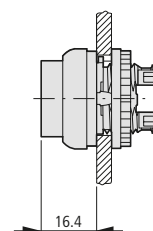

RMQ-Titan mushroom pushbuttons

M22...-DP-...

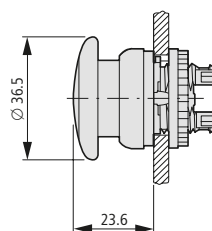

Compact indicator lights Compact acoustic devices

M22-LC-...
M22-AM...

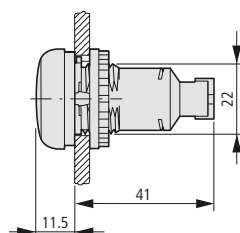

M22-LCH-...

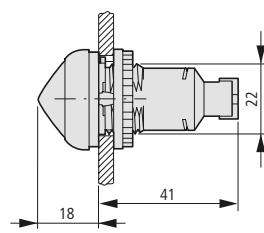

Potentiometers

M22...-R...K

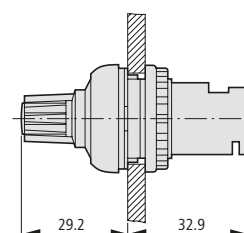

Controlled stop/emergency stop buttons

Mushroom-shaped

M22-PV...

M22S-PV...

M22-PVL...

M22-PVS...

Palm shaped

M22-PV...45...

M22-PV...60...

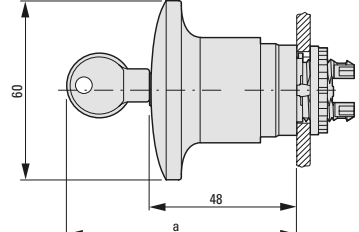
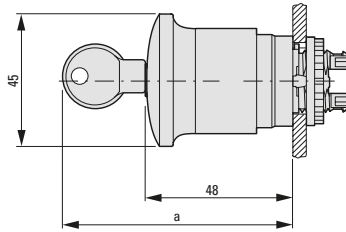
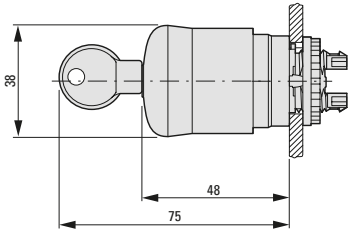

Front mounting (style: flush mounting)

Mounting adapters

M22-A4

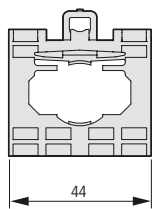

M22-A

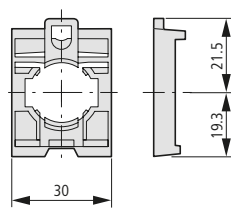

Centering adapter

M22-ZA

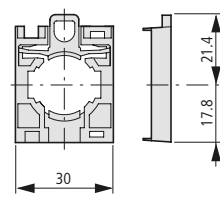

RMQ-Titan indicator lights

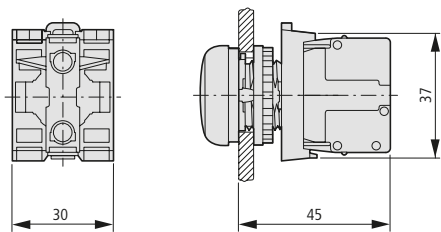

Buttons with M22-(C)K...

Buttons with M22-(C) LED... + M22-XLED...

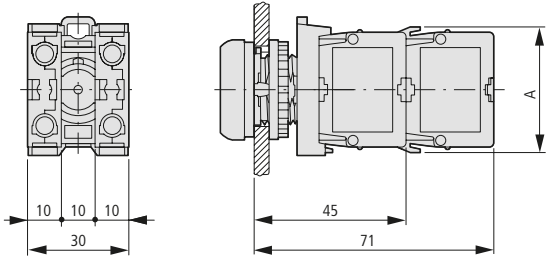

IVS top-hat rail adapter

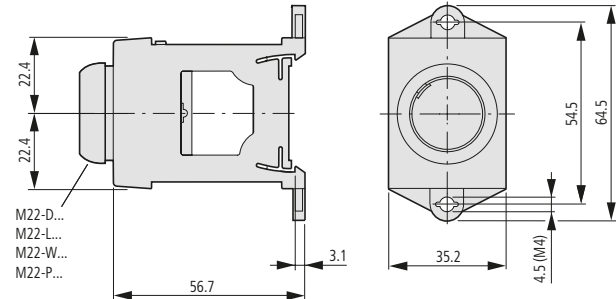

	1 x M22-K...	2 x M22-K...	1 x M22-CK...	2 x M22-CK...
A	37.2	37.2	39	39

Pushbuttons, indicator lights with M22-TC telescopic clip and M22-TCV extension

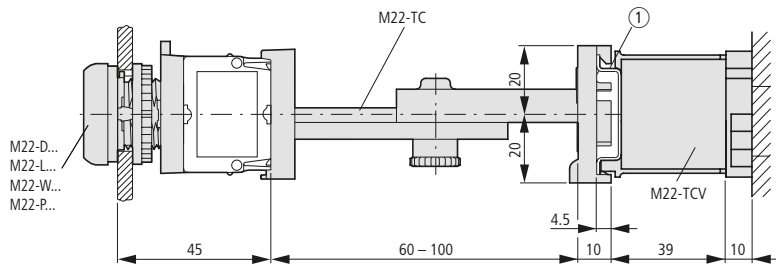

Pushbuttons with Flat Rear contact element ①

Pushbuttons with standard contact element ②

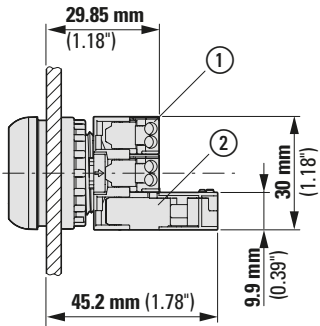

① IEC/EN 60715 DIN-rail

① M22-FK10(01)
② M22-(C)K...

Front mounting (style: flush mounting)

RMQ-Titan mounting plates

M22-E...

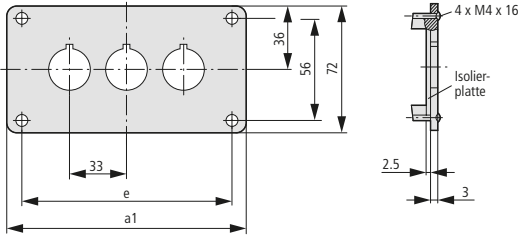

Part no.	a1	e
M22-E(Y)1	72	56
M22-E2	105	89
M22-E3	138	122
M22-E4	171	155
M22-E5	204	188
M22-E6	237	221

Shrouds

M22-H...

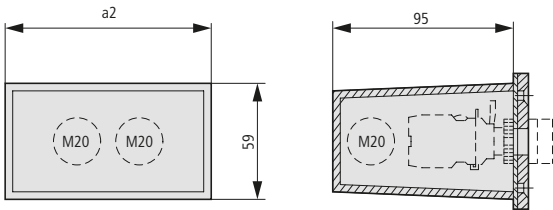

Part no.	a2	Cable entry	Design
M22-H1	42	3 x M20	One-piece
M22-H2	75	4 x M20	
M22-H3	108	4 x M20	
M22-H4	141	4 x M20	Split
M22-H5	174	5 x M20	
M22-HE6	207	6 x M20	

Shroud with plaster keys

M22-UPE

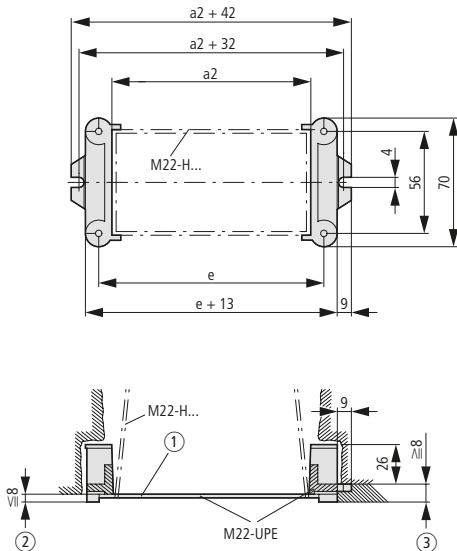

- ① Box for proper plasterboard mounting
- ② Plaster thickness of less than 8 mm
- ③ Plaster thickness of more than 8 mm

Base mounting (style: surface mounting)

RMQ-Titan surface mounting enclosures

M22-I...

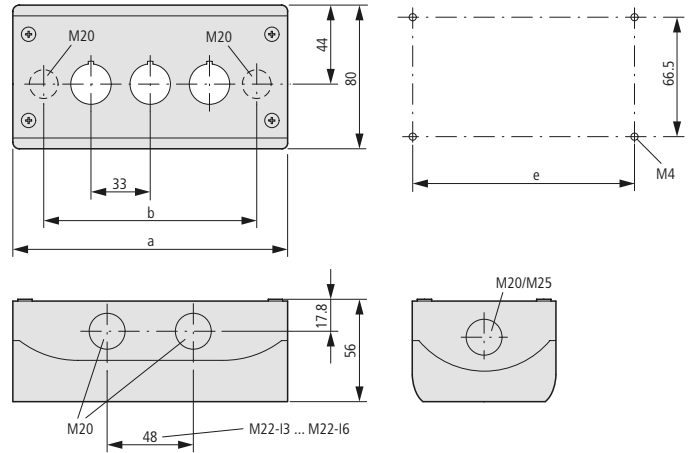

Part no.	Mounting locations	a	b	e	Cable entries		
					2 x M16	3 x M20	2 x M25
M22-I(Y)1	1	72	42.6	58.5	2 x M16	3 x M20	2 x M25
M22-I2	2	120	85.6	106.5	2 x M20	3 x M20	2 x M25
M22-I3	3	153	118.6	139.5	2 x M20	2 x M25	4 x M20
M22-I4	4	186	151.6	172.5	2 x M20	2 x M25	4 x M20
M22-I6	6	252	217.6	238.5	2 x M20	2 x M25	4 x M20

Combination of surface mounting enclosures

M22-XI

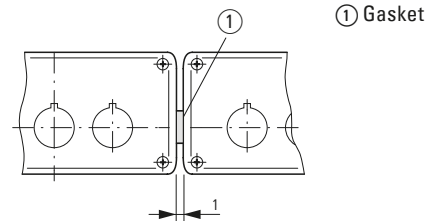

Surface mounting enclosure for 12 mounting locations

M22-I12

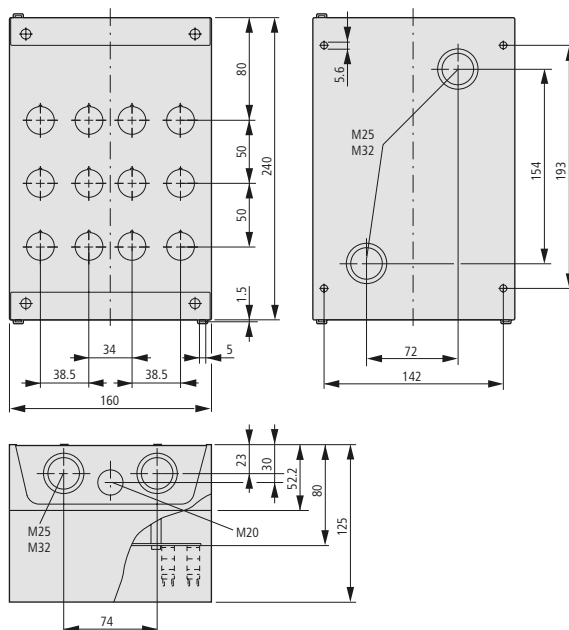

Legend holders

M22S-ST...

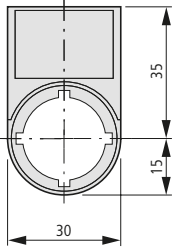

M22S-STDD-X

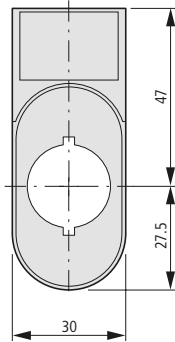

Mounting hole with key slot for M22..., C22...

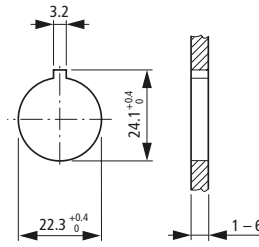

Grid dimensions as defined in IEC/EN 60947

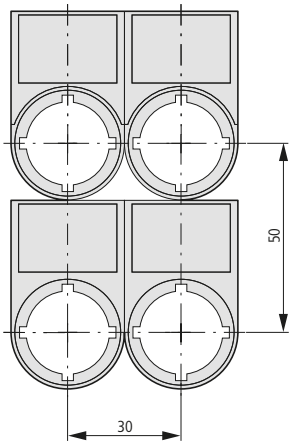

Grid dimensions for various combinations

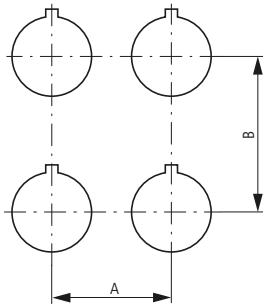

Pushbutton diaphragm cannot be combined with label mount

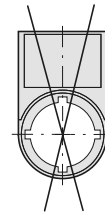

Part no.	A ≥ mm	B ≥ mm
M22(N/O)-... (IEC/EN 60947)	30	50
RMQ-Titan min.	30	40
M22-D... + M22-T-D	33	40
M22-D(R)P...	38	40
M22-PV...	45	45
M22-PV...45	55	55
M22-PV...60	70	70
M22-PV(L) + M22-PL-PV	48	56
M22-PV(L)(N/O...) + M22-D...	33	40
M22-DDL...	30	55
M22-DDL... + M22-T-DD	33	58
M22-ST...	30	50
M22-STDD...	30	75
M22-CK...	30	45
M22-CLED...	30	45
M22-XAK...	90	90
M22-XZK...	33	52
M22-XBK...	60	60
M22-XYK...	50	50
M22-D4	60	60
M22-WR...4	50	50
M22-W...J4	100	100

Grid dimensions for M22-DD...

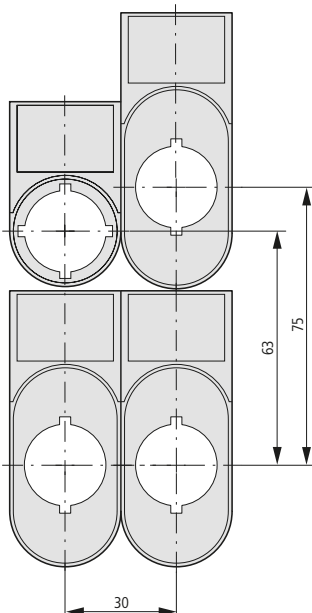

Grid dimensions for M22-DDL

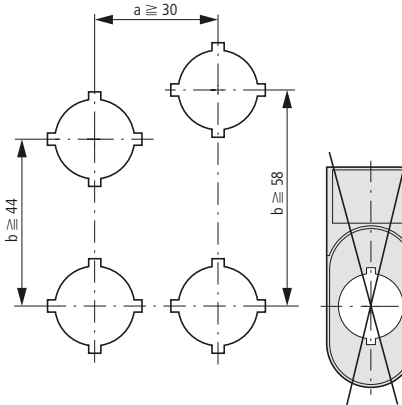

M22-T-DD pushbutton diaphragm
Pushbutton diaphragm cannot be combined with label mount

1

Emergency stop sealable shroud

M22-PL-PV

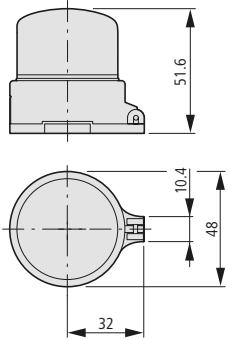

Blanking plug

M22...B...

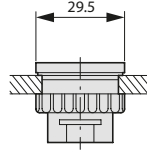

Pushbutton diaphragms

M22-T-D

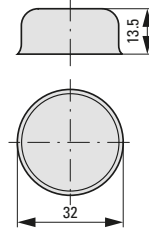

M22-T-D

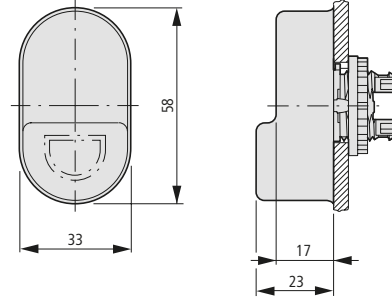

Guard rings

M22-XGWK

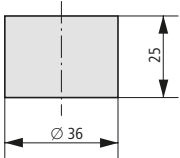

M22-XGPV

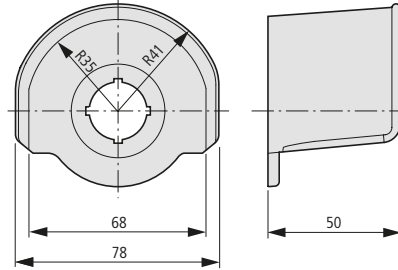

Protective diaphragm

M22-XWS

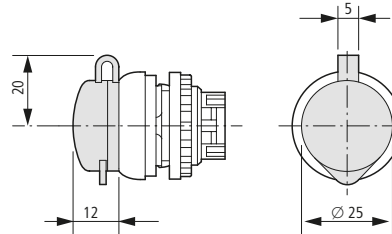

Controlled stop legend plates

M22-XAK...

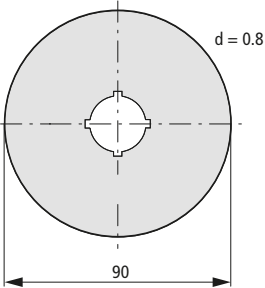

M22-X(Y)ZK...

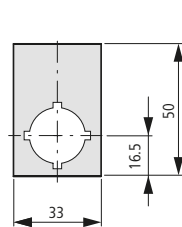

M22-XBK...

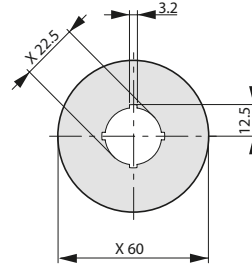

M22-XYK...

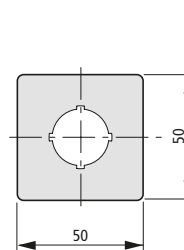

Joysticks

M22...-W...J...

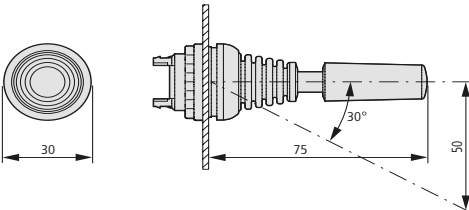

4-way pushbuttons

M22-D...4...

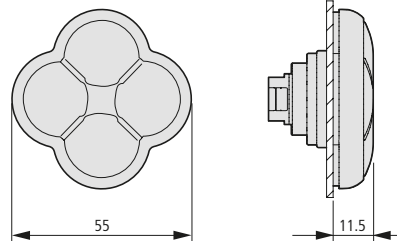

Joysticks

M22-WJ..., M22-WRJ...

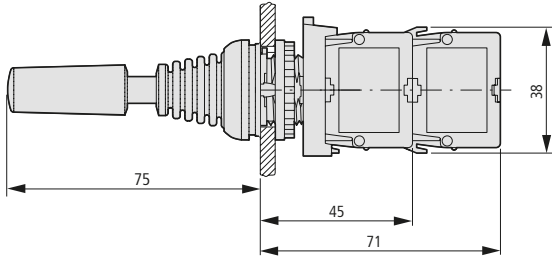

Mounting adapter

M22-A4

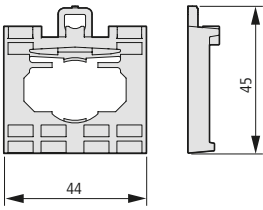

Dust covers

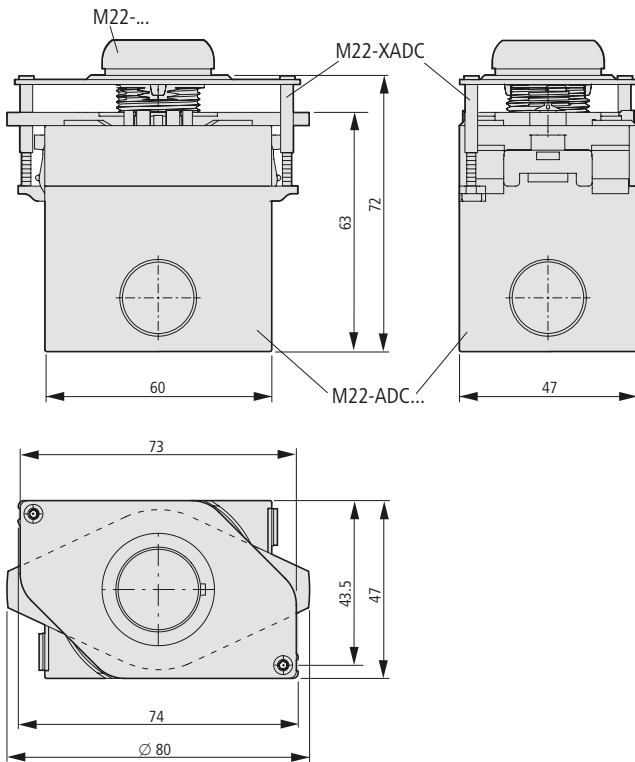

1

Mounting adapters (front mounting) for 3 contact/LED elements

M22-A

M22-SWD-A4

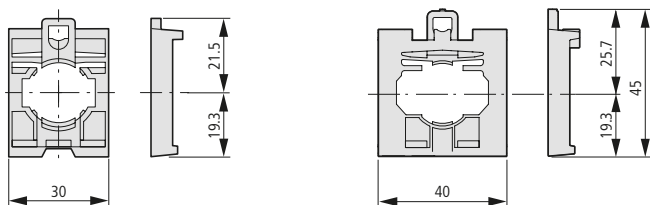

Function elements

M22-SWD-K...
M22-SWD-LED...

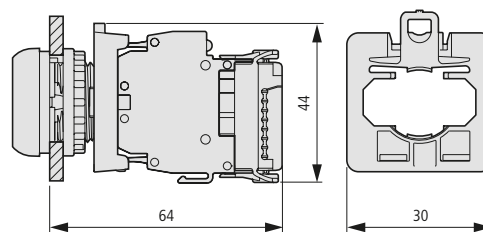

Housing bushing plug

SWD4-SM8-20

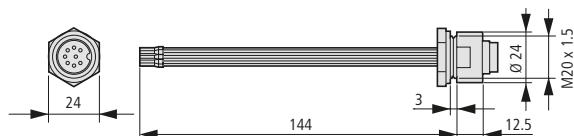

Housing bushing socket

SWD4-SF8-20

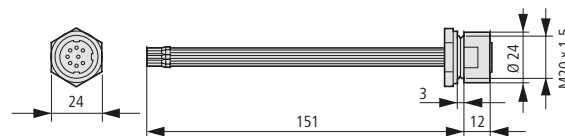

Plug connector for SmartWire-DT round cable, straight

SWD4-SF8-67

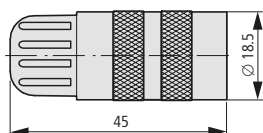

SWD4-SM8-67

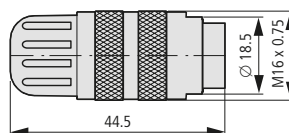

Plug connector for SmartWire-DT round cable, right angle

SWD4-SF8-67W

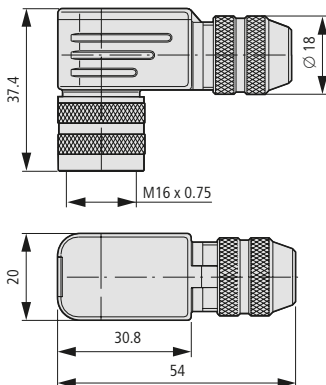

SWD4-SM8-67W

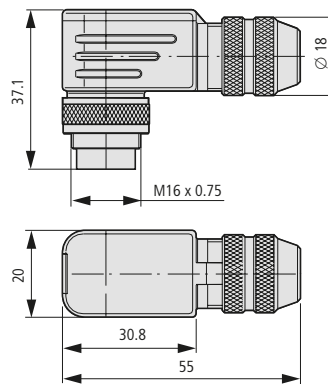

M30.... with 2 M22-K... standard contact elements

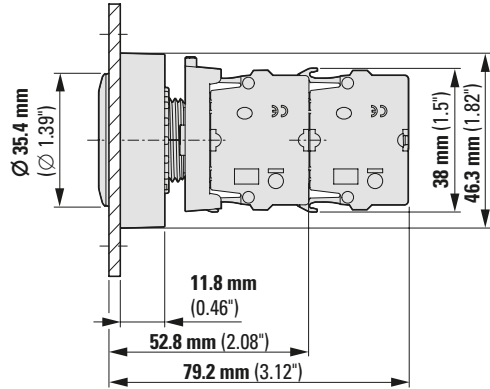

M30.... with M22-FK... Flat Rear contact elements

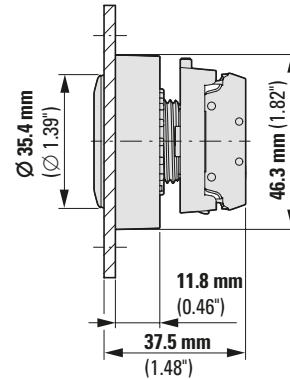

Pushbuttons, blanking plug

M30C-FD...
M30C-FB

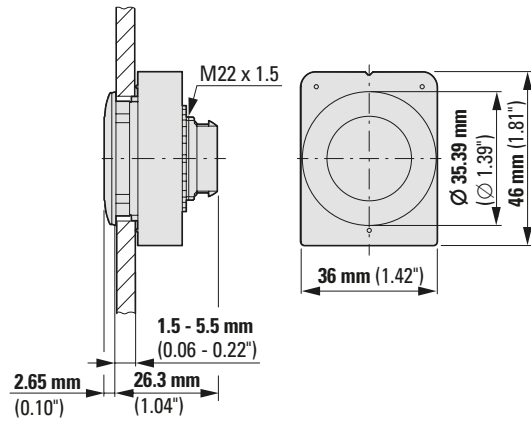

Indicator lights

M30C-FL...

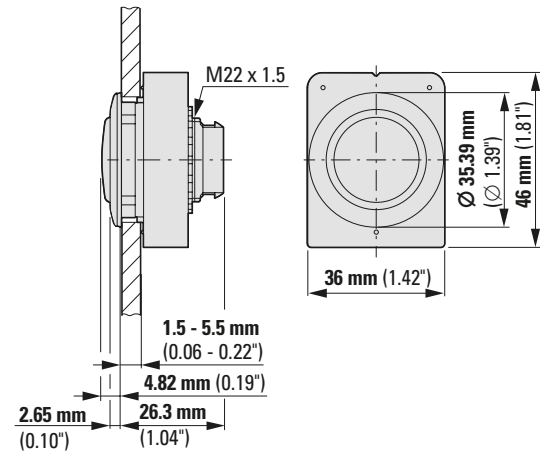

Selector switches

With rotary head
M30C-FW...

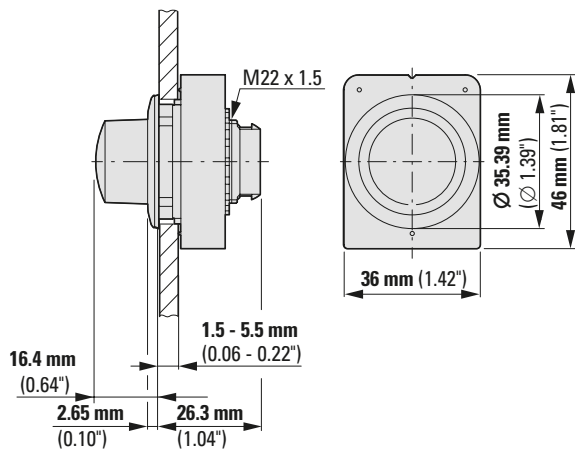

(Illuminated) selector switches

With thumb-grip, 4-way
M30C-FW(L)K(V)...

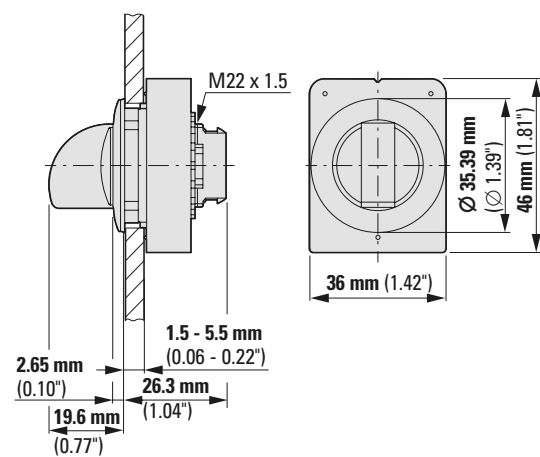

1

Key-operated buttons

M30C-FW(R)S(3)-MS...

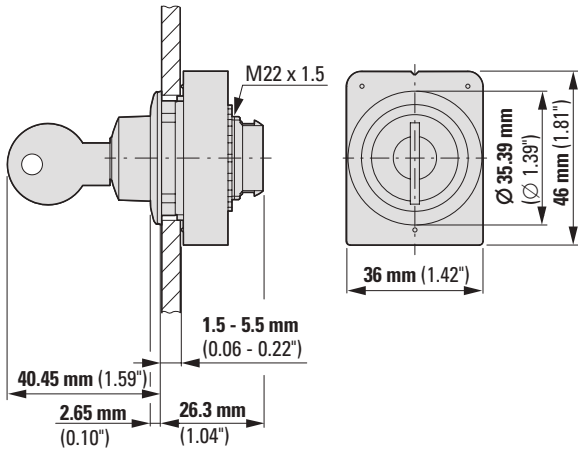

M30C-FW(R)S(3)-RS...

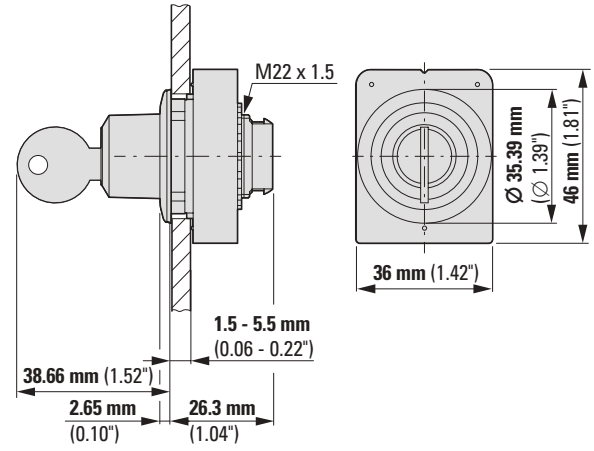

Key-operated buttons

M30C-FW(R)S(3)-SA...

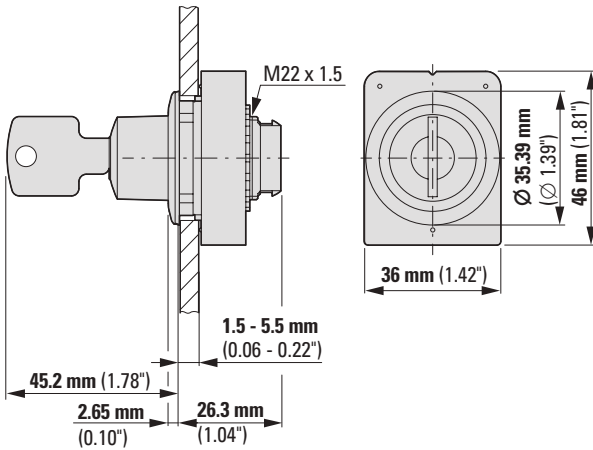

Potentiometers

M30C-FR...

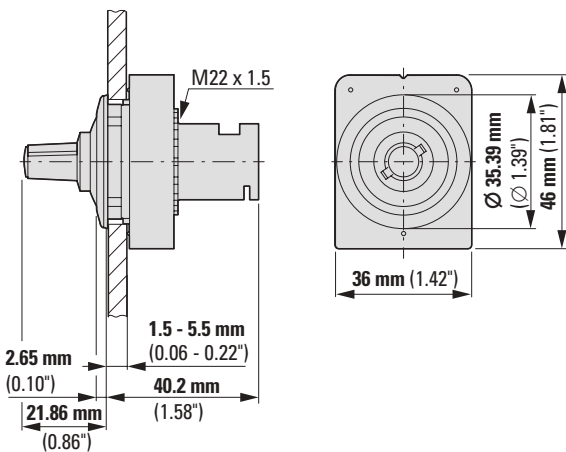

Potentiometers, SmartWire-DT

M30C-FR-SWD

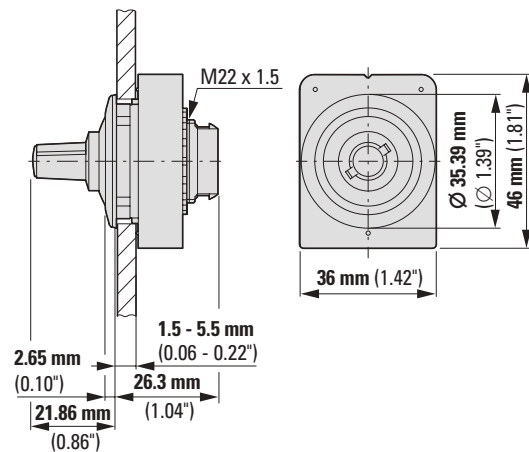

Encoders, SmartWire-DT

M30C-FINC-SWD

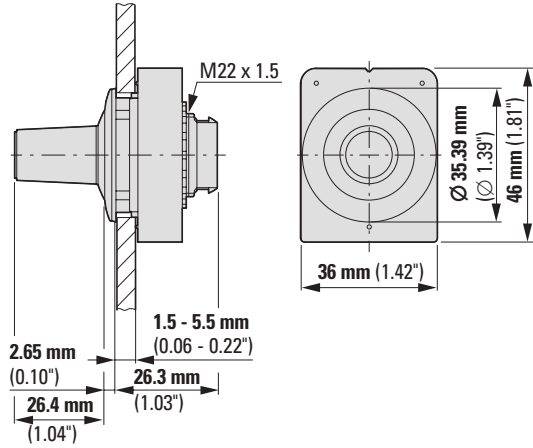

Joysticks

M30C-FW(R)JS...

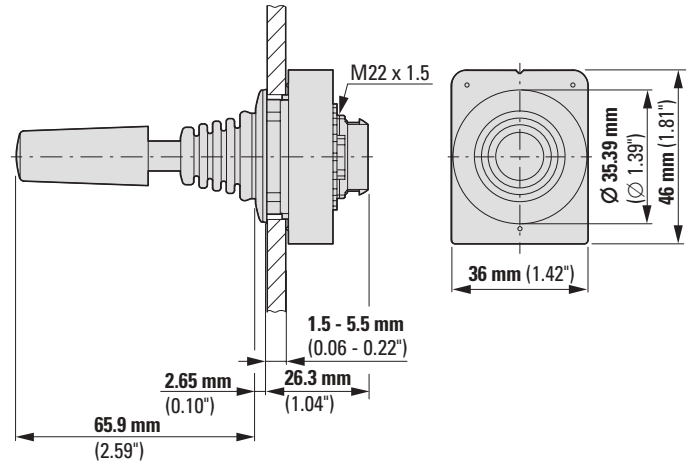

Mounting hole without key slot

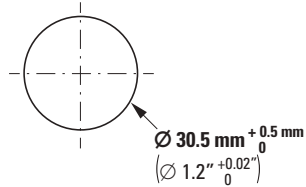

Mounting hole with key slot

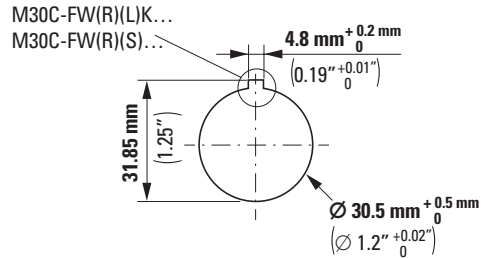

Grid dimensions for various combinations

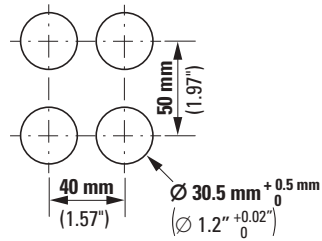

Build it in.



WWW.TM2A.PT info@tm2a.pt

WWW.TM2A.PT info@tm2a.pt

RMQ *compact* solution Simple. Reliable. Compact.



Download the brochure
by visiting the product page
www.eaton.eu/RMQcompact

The C22 and C30 RMQ *compact* solution series combine connection cables with or without a plug connection together with signaling and operator elements into a single device. This turns them into an all-in-one solution that provides full protection against dust, fine foreign particles, and liquids, for example. Thanks to a high degree of protection of up to IP69K in the front and IP65 in the back, these devices are perfect for direct installation in applications such as woodworking machines and similar machine tools.

RMQ *compact* solution devices feature a sleek design that enhances machines, systems, and a broad range of additional applications. Whether you decide on our traditional C22 design or on the flush C30 version, you can rest assured knowing that we have a solution for every application out there.

C20
C30



2.0 RMQ compact solution	
2.1 System overview	
C22 – System overview	96
2.2 Product selection	
C22 – Controlled stop/emergency-stop buttons.	98
C22 – Pushbuttons.	99
C22 – Selector switches.	102
C22 – Key-operated buttons.	104
C22 – Indicator lights	106
C22 – Illuminated pushbutton actuators	108
C22 – Illuminated pushbutton actuators, accessories	109
2.3 System overview	
C30 – System overview	110
2.4 Product selection	
C30 – Pushbuttons.	111
C30 – Indicator lights	113
C30 – Illuminated pushbutton actuators, accessories	114
2.5 Technical data	
C22/C30 – Technical data	115
2.6 Dimensions	
C22 – Dimensions	116
C30 – Dimensions	120

2.1

RMQ compact solution

C22 – System overview

Moeller series

System overview

2

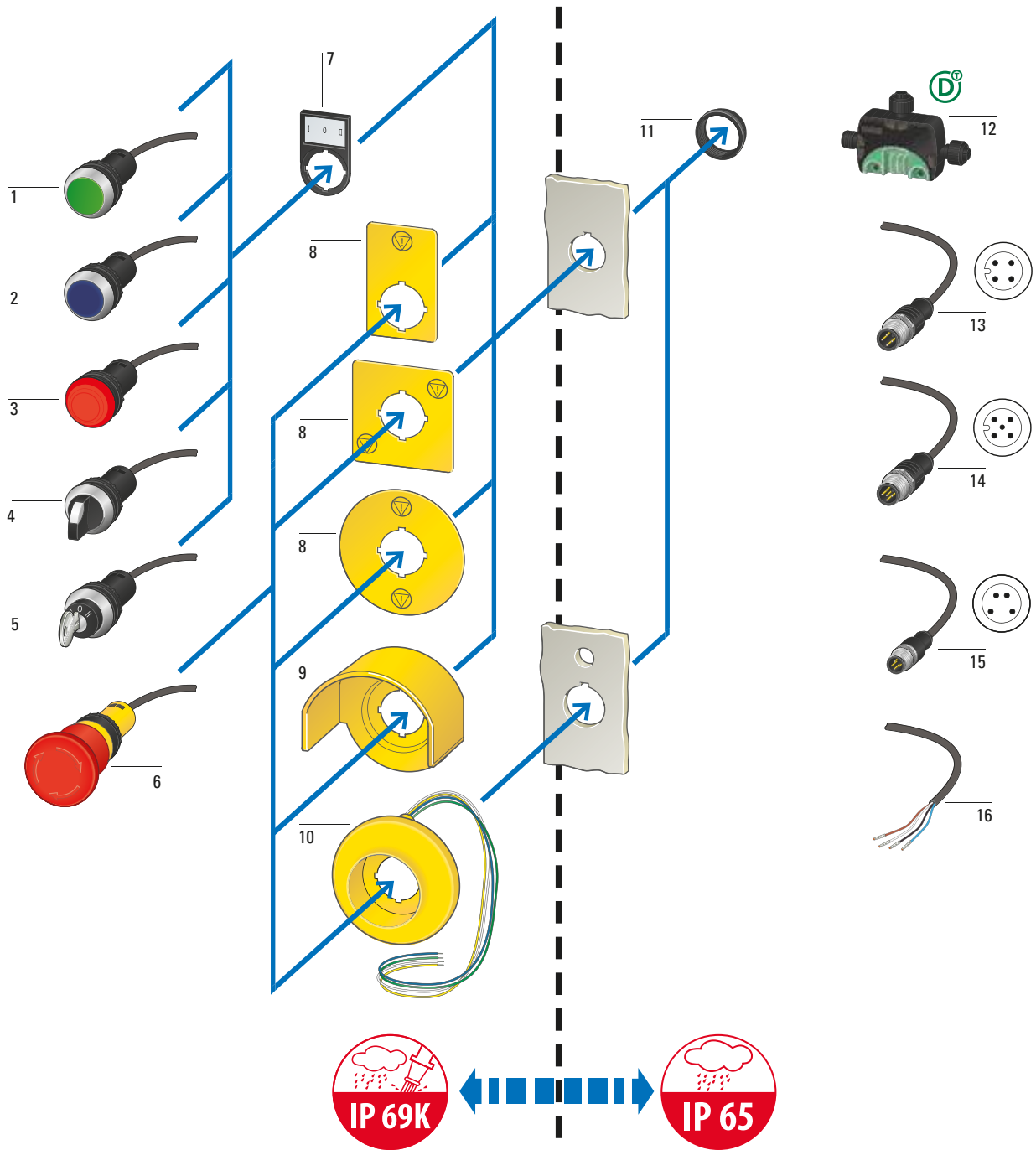

WWW.TM2A.PT info@tm2a.pt

WWW.TM2A.PT info@tm2a.pt

C22 pushbuttons	1	C22 key-operated buttons	5	Illuminated rings	10
Momentary and maintained		Momentary and maintained		Versions:	
Flush		Flush		24 V AC/DC, 120 V AC, 230 V AC	
Colors: white, green, red, black		2 or 3 positions		Continuous light	
With cable (0.2/0.5/1/3.5 m) and plug (M12A or M8, 4 pole) or unterminated cable end (4 pole)		With cable (0.2/1/3.5 m) and plug (M12A or M8, 4 pole) or unterminated cable end (4 pole)		Flashing light with separate driver	
→ Page 99		→ Page 103		Chaser light with separate driver, 24 V AC/DC	
				With three LED rows that can be driven separately	
				→ Page 16	
C22 illuminated pushbutton actuators	2	C22 controlled stop/emergency-stop buttons	6	Threaded rings	11
Momentary and maintained		Flush		→ Page 70	
Flush		38 mm and 45 mm diameter			
Colors: white, green, red, blue, yellow		Mushroom or palm			
With cable (0.2/0.5/1/3.5 m) and plug (M12A or M8, 4 pole) or unterminated cable end (4 pole)		Twist or pull release			
24 V AC/DC		Tamper-proof as defined in ISO 13850/EN 418		SmartWire-DT I/O module	12
→ Page 108		European Machinery Safety Directive 2006/42/EC		For connecting digital input/output signals to SmartWire-DT	
		With cable (0.2/1/3.5 m) and plug (M12A, 5 pole) or unterminated cable end (4 pole)		IP67	
		→ Page 98		Cable with M12A plug, 4 pole	13
C22 indicator lights	3			Cable with M12A plug, 5 pole	14
Flush		Label mounts	7	Cable with M8 plug, 4 pole	15
Colors: white, green, red, blue, yellow		For insert labels		Cable end open, 4 pole	16
With cable (0.2/0.5/1/3.5 m) and plug (M12A or M8, 4 pole) or unterminated cable end (4 pole)		Color: black			
24 V AC/DC		Insert labels: aluminum color, with inscription or blank, suitable for engraving			
→ Page 106		→ Page 16			
C22 selector switches	4	Controlled STOP legend plates, IP66	8		
Momentary and maintained		Color: yellow, with black lettering			
Flush		Round, rectangular, or square			
With thumb-grip		With controlled stop inscription or controlled stop symbol			
2 or 3 positions		→ Page 17			
With cable (0.2/1/3.5 m) and plug (M12A or M8, 4 pole) or unterminated cable end (4 pole)					
→ Page 102		Guard rings	9		
		For preventing unintended actuation			
		For 38 mm and 45 mm designs			
		→ Page 16			













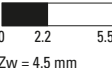

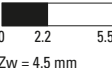

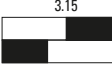

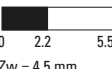

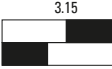
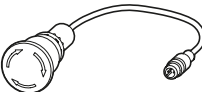
Product selection

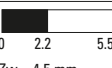
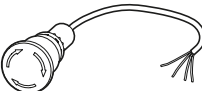
2

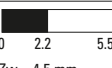
Connection type	Cable length m	Mushroom head	Contact configuration ¹⁾ N/C = Normally closed contact N/O = Normally open contact	Contact sequence	Contact diagram ²⁾	Part no. Article no.	Std. pack
-----------------	-------------------	---------------	---	------------------	-------------------------------	-------------------------	-----------

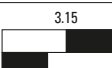
Controlled stop/emergency switching off buttons

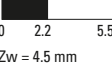
Non-illuminated
Tamper-proof as defined in ISO 13850, EN 418
IP66, IP67, IP69K (at front)
IP65 (at rear)
Yellow base

Mushroom-shaped Pull release 38 mm diameter 	Cable (black) with M12A plug, 5 pole	0.2	●	2 N/C ⊕		 Zw = 4.5 mm	C22-PV-K02-P10 185184	1 unit
Mushroom-shaped Pull release 38 mm diameter 	Cable (black) with unterminated end, 4 pole	1	●	2 N/C ⊕		 Zw = 4.5 mm	C22-PV-K02-P62 185169	1 unit
		3.5					C22-PV-K02-P65 185170	
		1		1 N/C ⊕ 1 N/O		 Zw = 4.5 mm	C22-PV-K11-P62 185174	
		3.5					C22-PV-K11-P65 185175	
Mushroom-shaped Turn-to-release function 38 mm diameter 	Cable (black) with unterminated end, 4 pole	1	●	2 N/C ⊕		 Zw = 4.5 mm	C22-PVT-K02-P62 185176	1 unit
		3.5					C22-PVT-K02-P65 185177	
		1		1 N/C ⊕ 1 N/O		 Zw = 4.5 mm	C22-PVT-K11-P62 185181	
		3.5					C22-PVT-K11-P65 185182	
Palm Turn-to-release function 45 mm diameter 	Cable (black) with M12A plug, 5 pole	0.2	●	2 N/C ⊕		 Zw = 4.5 mm	C22-PVT45P-K02-P10 185183	1 unit
Palm Turn-to-release function 45 mm diameter 	Cable (black) with unterminated end, 4 pole	1	●	2 N/C ⊕		 Zw = 4.5 mm	C22-PVT45P-K02-P62 185155	1 unit
		3.5					C22-PVT45P-K02-P65 185156	
		1		1 N/C ⊕ 1 N/O		 Zw = 4.5 mm	C22-PVT45P-K11-P62 185160	
		3.5					C22-PVT45P-K11-P65 185161	
Palm Turn-to-release function 45 mm diameter With mechanical position indicator ³⁾ 	Cable (black) with unterminated end, 4 pole	1	●	2 N/C ⊕		 Zw = 4.5 mm	C22-PVT45P-MPI-K02-P62 185162	1 unit
		3.5					C22-PVT45P-MPI-K02-P65 185163	
		1		1 N/C ⊕ 1 N/O		 Zw = 4.5 mm	C22-PVT45P-MPI-K11-P62 185167	
		3.5					C22-PVT45P-MPI-K11-P65 185168	

Notes

¹⁾ ⊕ = Safety function implemented with positive opening as defined in IEC/EN 60947-5-1

²⁾ Contact sequence ■ = Contact closed □ = Contact open

³⁾ Green switch position indicator → Button not activated

Cable length	Button plate	Contact configuration ¹⁾	Contact sequence ²⁾	Contact diagram	Part no. Article no.	Part no. Article no.	Std. pack
m		N/O = Normally open contact	N/C = Normally closed contact		Momentary	Maintained	

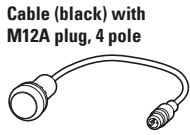

Pushbuttons

Silver bezel
IP66, IP67, IP69K (at front), IP65 (at rear)
Flush

0.2		1 N/C ⊕			Zw = 4.5 mm	C22-D-R-K01-P1 185675	C22-DR-R-K01-P1 185684	1 unit	
						C22-D-S-K01-P1 185676	C22-DR-S-K01-P1 185685		
	Without button plate					C22-D-X-K01-P1 185678	C22-DR-X-K01-P1 185687		
	0.2		1 N/O			Zw = 4.5 mm	C22-D-G-K10-P1 185674	C22-DR-G-K10-P1 185683	1 unit
							C22-D-W-K10-P1 185677	C22-DR-W-K10-P1 185686	
		Without button plate					C22-D-X-K10-P1 185680	C22-DR-X-K10-P1 185689	
0.5			1 N/C ⊕			Zw = 4.5 mm	C22-D-R-K01-P3 181633	C22-DR-R-K01-P3 181611	1 unit
							C22-D-S-K01-P3 181634	C22-DR-S-K01-P3 181612	
		Without button plate					C22-D-X-K01-P3 181605	C22-DR-X-K01-P3 181614	
	0.5		1 N/O			Zw = 4.5 mm	C22-D-G-K10-P3 181632	C22-DR-G-K10-P3 181610	1 unit
							C22-D-W-K10-P3 181635	C22-DR-W-K10-P3 181613	
		Without button plate					C22-D-X-K10-P3 181607	C22-DR-X-K10-P3 181616	
1			1 N/C ⊕			Zw = 4.5 mm	C22-D-R-K01-P5 181043	C22-DR-R-K01-P5 181081	1 unit
							C22-D-S-K01-P5 181045	C22-DR-S-K01-P5 181083	
		Without button plate					C22-D-X-K01-P5 181049	C22-DR-X-K01-P5 181087	
	1		1 N/O			Zw = 4.5 mm	C22-D-G-K10-P5 181041	C22-DR-G-K10-P5 181079	1 unit
							C22-D-W-K10-P5 181047	C22-DR-W-K10-P5 181085	
		Without button plate					C22-D-X-K10-P5 181051	C22-DR-X-K10-P5 181089	

Notes

¹⁾ ⊕ = Safety function implemented with positive opening as defined in IEC/EN 60947-5-1

²⁾ Contact sequence: = Contact closed = Contact open

Cable length m	Button plate	Contact configuration ¹⁾ N/O = Normally open contact	Contact sequence ²⁾	Contact diagram	Momentary	Maintained	Std. pack
					Part no. Article no.	Part no. Article no.	

Cable (black) with M8 plug, 4 pole



Pushbuttons

Silver bezel
IP66, IP67, IP69K (at front), IP65 (at rear)
Flush

0.2		1 N/C ⊕		 Zw = 4.5 mm	C22-D-R-K01-P30 185693	C22-DR-R-K01-P30 185702	1 unit	
					C22-D-S-K01-P30 185694	C22-DR-S-K01-P30 185703		
	Without button plate				C22-D-X-K01-P30 185696	C22-DR-X-K01-P30 185705		
	Without button plate		1 N/O		 Zw = 4.5 mm	C22-D-G-K10-P30 185692	C22-DR-G-K10-P30 185701	
						C22-D-W-K10-P30 185695	C22-DR-W-K10-P30 185704	
		Without button plate				C22-D-X-K10-P30 185698	C22-DR-X-K10-P30 185707	
0.5		1 N/C ⊕		 Zw = 4.5 mm	C22-D-R-K01-P31 185635	C22-DR-R-K01-P31 185644	1 unit	
					C22-D-S-K01-P31 185636	C22-DR-S-K01-P31 185645		
	Without button plate				C22-D-X-K01-P31 185638	C22-DR-X-K01-P31 185647		
	Without button plate		1 N/O		 Zw = 4.5 mm	C22-D-G-K10-P31 185634	C22-DR-G-K10-P31 185643	
						C22-D-W-K10-P31 185637	C22-DR-W-K10-P31 185646	
		Without button plate				C22-D-X-K10-P31 185640	C22-DR-X-K10-P31 185649	
1		1 N/C ⊕		 Zw = 4.5 mm	C22-D-R-K01-P32 185653	C22-DR-R-K01-P32 185662	1 unit	
					C22-D-S-K01-P32 185654	C22-DR-S-K01-P32 185663		
	Without button plate				C22-D-X-K01-P32 185656	C22-DR-X-K01-P32 185665		
	Without button plate		1 N/O		 Zw = 4.5 mm	C22-D-G-K10-P32 185652	C22-DR-G-K10-P32 185661	
						C22-D-W-K10-P32 185655	C22-DR-W-K10-P32 185664	
		Without button plate				C22-D-X-K10-P32 185658	C22-DR-X-K10-P32 185667	

Notes

¹⁾ ⊕ = Safety function implemented with positive opening as defined in IEC/EN 60947-5-1

²⁾ Contact sequence: = Contact closed = Contact open

Cable length	Button plate	Contact configuration ¹⁾	Contact sequence ²⁾	Contact diagram	Part no. Article no.	Part no. Article no.	Std. pack
m		N/O = Normally open contact N/C = Normally closed contact			Momentary	Maintained	

Cable (black) with unterminated end, 4 pole



Pushbuttons

Silver bezel
IP66, IP67, IP69K (at front), IP65 (at rear)
Flush

1	●	1 N/C ⊕			Zw = 4.5 mm	C22-D-R-K01-P62	C22-DR-R-K01-P62	1 unit	
						185671	185608		
	●	1 N/C ⊕			Zw = 4.5 mm	C22-D-S-K01-P62	C22-DR-S-K01-P62		
						185672	185609		
	Without button plate						C22-D-X-K01-P62	C22-DR-X-K01-P62	
	Without button plate		2 N/C ⊕			Zw = 4.5 mm	C22-D-X-K02-P62	C22-DR-X-K02-P62	
	Without button plate		1 N/O	1 N/C ⊕			C22-D-X-K11-P62	C22-DR-X-K11-P62	
	Without button plate		1 N/O	1 N/C ⊕			C22-D-G-K10-P62	C22-DR-G-K10-P62	
	Without button plate		1 N/O	1 N/C ⊕			C22-D-W-K10-P62	C22-DR-W-K10-P62	
	Without button plate		2 N/O	1 N/C ⊕			C22-D-X-K10-P62	C22-DR-X-K10-P62	
Without button plate		2 N/O	1 N/C ⊕			C22-D-X-K20-P62	C22-DR-X-K20-P62		
Without button plate		2 N/O	1 N/C ⊕			C22-D-X-K20-P62	C22-DR-X-K20-P62		
3.5	●	1 N/C ⊕			Zw = 4.5 mm	C22-D-R-K01-P65	C22-DR-R-K01-P65	1 unit	
						185617	185626		
	●	1 N/C ⊕			Zw = 4.5 mm	C22-D-S-K01-P65	C22-DR-S-K01-P65		
						185618	185627		
	Without button plate						C22-D-X-K01-P65	C22-DR-X-K01-P65	
	Without button plate		2 N/C ⊕			Zw = 4.5 mm	C22-D-X-K02-P65	C22-DR-X-K02-P65	
	Without button plate		1 N/O	1 N/C ⊕			C22-D-X-K11-P65	C22-DR-X-K11-P65	
	Without button plate		1 N/O	1 N/C ⊕			C22-D-G-K10-P65	C22-DR-G-K10-P65	
	Without button plate		1 N/O	1 N/C ⊕			C22-D-W-K10-P65	C22-DR-W-K10-P65	
	Without button plate		2 N/O	1 N/C ⊕			C22-D-X-K10-P65	C22-DR-X-K10-P65	
Without button plate		2 N/O	1 N/C ⊕			C22-D-X-K20-P65	C22-DR-X-K20-P65		
Without button plate		2 N/O	1 N/C ⊕			C22-D-X-K20-P65	C22-DR-X-K20-P65		

Notes

















¹⁾ ⊕ = Safety function implemented with positive opening as defined in IEC/EN 60947-5-1

²⁾ Contact sequence: ■ = Contact closed □ = Contact open

Function:	Contact configuration ¹⁾	Contact sequence	Contact diagram ²⁾	Part no. Article no.	Part no. Article no.	Std. pack
▷ = Momentary ▽ = Maintained	N/O = Normally open contact N/C = Normally closed contact					

Selector switches

Silver bezel
 With thumb-grip
 IP66 (at front), IP65 (at rear)

Cable length of 0.2 m	Cable length of 1 m	Cable length of 0.2 m		Cable length of 1 m		Std. pack		
		Part no. Article no.	Part no. Article no.	Part no. Article no.	Part no. Article no.			
2 positions Cable (black) with M12A plug, 4 pole 	1 N/O	▷ 40°	1 N/O			C22-WK-K10-P1 186098	C22-WK-K10-P5 186114	1 unit
		▽ 60°				C22-WRK-K10-P1 186103	C22-WRK-K10-P5 186119	
2 positions Cable (black) with M8 plug, 4 pole 	1 N/O	▷ 40°	1 N/O			C22-WK-K10-P30 186130	C22-WK-K10-P32 186146	1 unit
		▽ 60°				C22-WRK-K10-P30 186135	C22-WRK-K10-P32 186151	
2 positions Cable (black) with unterminated end, 4 pole 	1 N/C ⊕	▷ 40°	1 N/C ⊕			C22-WK-K01-P62 186161	C22-WK-K01-P65 186177	1 unit
		▽ 60°				C22-WRK-K01-P62 186166	C22-WRK-K01-P65 186182	
	2 N/C ⊕	▷ 40°	2 N/C ⊕			C22-WK-K02-P62 186158	C22-WK-K02-P65 186174	
		▽ 60°				C22-WRK-K02-P62 186163	C22-WRK-K02-P65 186179	
	1 N/O 1 N/C ⊕	▷ 40°	1 N/O 1 N/C ⊕			C22-WK-K11-P62 186159	C22-WK-K11-P65 186175	
		▽ 60°				C22-WRK-K11-P62 186164	C22-WRK-K11-P65 186180	
	1 N/O	▷ 40°	1 N/O			C22-WK-K10-P62 186162	C22-WK-K10-P65 186178	
		▽ 60°				C22-WRK-K10-P62 186167	C22-WRK-K10-P65 186183	
	2 N/O	▷ 40°	2 N/O			C22-WK-K20-P62 186160	C22-WK-K20-P65 186176	
		▽ 60°				C22-WRK-K20-P62 186165	C22-WRK-K20-P65 186181	

Notes

¹⁾ ⊕ = Safety function implemented with positive opening as defined in IEC/EN 60947-5-1

²⁾ Contact sequence: ■ = Contact closed □ = Contact open

Function:	Contact configuration ¹⁾	Contact sequence	Contact diagram ²⁾	Cable length of 0.2 m	Cable length of 1 m	Std. pack
				Part no. Article no.	Part no. Article no.	
▷ = Momentary ▽ = Maintained	N/O = Normally open contact N/C = Normally closed contact					

Selector switches

Silver bezel
 With thumb-grip
 IP66 (at front), IP65 (at rear)

**3 positions
 Cable (black) with
 M12A plug, 4 pole**



40° ▷ ▽ 40°	2 N/O			C22-WK3-K20-P1 186106	C22-WK3-K20-P5 186122	1 unit
60° ▽ 60°				C22-WRK3-K20-P1 186109	C22-WRK3-K20-P5 186125	

**3 positions
 Cable (black) with
 M8 plug, 4 pole**



40° ▷ ▽ 40°	2 N/O			C22-WK3-K20-P30 186138	C22-WK3-K20-P32 186154	1 unit
60° ▽ 60°				C22-WRK3-K20-P30 186141	C22-WRK3-K20-P32 186157	

**3 positions
 Cable (black) with
 unterminated end, 4 pole**



40° ▷ ▽ 40°	2 N/C ⊕			C22-WK3-K02-P62 186168	C22-WK3-K02-P65 186184	1 unit
60° ▽ 60°			Zw = 4.5 mm	C22-WRK3-K02-P62 186171	C22-WRK3-K02-P65 186187	
40° ▷ ▽ 40°	1 N/O	1 N/C ⊕		C22-WK3-K11-P62 186169	C22-WK3-K11-P65 186185	
60° ▽ 60°				C22-WRK3-K11-P62 186172	C22-WRK3-K11-P65 186188	
40° ▷ ▽ 40°	2 N/O			C22-WK3-K20-P62 186170	C22-WK3-K20-P65 186186	
60° ▽ 60°				C22-WRK3-K20-P62 186173	C22-WRK3-K20-P65 186189	

Notes

¹⁾ ⊕ = Safety function implemented with positive opening as defined in IEC/EN 60947-5-1
²⁾ Contact sequence: ■ = Contact closed □ = Contact open













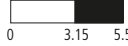

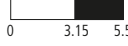
C22 – Key-operated buttons

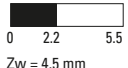
2

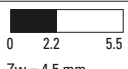
Function:	Key withdrawable at position	Contact configuration ¹⁾	Contact sequence	Contact diagram	Cable length of 0.2 m Part no. Article no.	Cable length of 1 m Part no. Article no.	Std. pack
▷	= Momentary	N/O = Normally open contact	N/C = Normally closed contact				
◁	= Maintained						

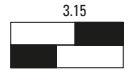
Key-operated buttons

Silver bezel
MS1 lock mechanism
Not suitable for master key systems
With 1 key
IP66 (at front), IP65 (at rear)

2 positions Cable (black) with M12A plug, 4 pole 	▷ 40°	0	1 N/O			C22-WS-MS1-K10-P1 186194	C22-WS-MS1-K10-P5 186210	1 unit
	◁ 60°	I	0			C22-WRS-MS1-K10-P1 186199	C22-WRS-MS1-K10-P5 186215	
2 positions Cable (black) with M8 plug, 4 pole 	▷ 40°	0	1 N/O			C22-WS-MS1-K10-P30 186226	C22-WS-MS1-K10-P32 186242	1 unit
	◁ 60°	I	0			C22-WRS-MS1-K10-P30 186231	C22-WRS-MS1-K10-P32 186247	
2 positions Cable (black) with unterminated end, 4 pole 	▷ 40°	0	1 N/C ⊕			C22-WS-MS1-K01-P62 186257	C22-WS-MS1-K01-P65 186273	1 unit
	◁ 60°	I	0			C22-WRS-MS1-K01-P62 186262	C22-WRS-MS1-K01-P65 186278	
	▷ 40°	0	2 N/C ⊕			C22-WS-MS1-K02-P62 186254	C22-WS-MS1-K02-P65 186270	
	◁ 60°	I	0			C22-WRS-MS1-K02-P62 186259	C22-WRS-MS1-K02-P65 186275	
	▷ 40°	0	1 N/O 1 N/C ⊕			C22-WS-MS1-K11-P62 186255	C22-WS-MS1-K11-P65 186271	
	◁ 60°	I	0			C22-WRS-MS1-K11-P62 186260	C22-WRS-MS1-K11-P65 186276	
	▷ 40°	0	1 N/O			C22-WS-MS1-K10-P62 186258	C22-WS-MS1-K10-P65 186274	
	◁ 60°	I	0			C22-WRS-MS1-K10-P62 186263	C22-WRS-MS1-K10-P65 186279	
	▷ 40°	0	2 N/O			C22-WS-MS1-K20-P62 186256	C22-WS-MS1-K20-P65 186272	
	◁ 60°	I	0			C22-WRS-MS1-K20-P62 186261	C22-WRS-MS1-K20-P65 186277	

Notes











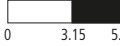

¹⁾ ⊕ = Safety function implemented with positive opening as defined in IEC/EN 60947-5-1

²⁾ Contact sequence ■ = Contact closed □ = Contact open

Function:	Key withdrawable at position	Contact configuration ¹⁾	Contact sequence	Contact diagram	Cable length of 0.2 m Part no. Article no.	Cable length of 1 m Part no. Article no.	Std. pack
▷	= Momentary	N/O = Normally open contact	N/C = Normally closed contact				
◁	= Maintained						

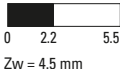
Key-operated buttons

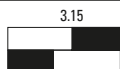
Silver bezel
MS1 lock mechanism
Not suitable for master key systems
With 1 key
IP66 (at front), IP65 (at rear)

3 positions Cable (black) with M12A plug, 4 pole 	40° ▷◁ 40°	0	2 N/O			C22-WS3-MS1-K20-P1 186202	C22-WS3-MS1-K20-P5 186218	1 unit
	60° ▷◁ 60°	I 0 II				C22-WRS3-MS1-K20-P1 186205	C22-WRS3-MS1-K20-P5 186221	
3 positions Cable (black) with M8 plug, 4 pole 	40° ▷◁ 40°	0	2 N/O			C22-WS3-MS1-K20-P30 186234	C22-WS3-MS1-K20-P32 186250	1 unit
	60° ▷◁ 60°	I 0 II				C22-WRS3-MS1-K20-P30 186237	C22-WRS3-MS1-K20-P32 186253	
3 positions Cable (black) with unterminated end, 4 pole 	40° ▷◁ 40°	0	2 N/C ²⁾			C22-WS3-MS1-K02-P62 186264	C22-WS3-MS1-K02-P65 186280	1 unit
	60° ▷◁ 60°	I 0 II				C22-WRS3-MS1-K02-P62 186267	C22-WRS3-MS1-K02-P65 186283	
	40° ▷◁ 40°	0	1 N/O 1 N/C ²⁾			C22-WS3-MS1-K11-P62 186265	C22-WS3-MS1-K11-P65 186281	
	60° ▷◁ 60°	I 0 II				C22-WRS3-MS1-K11-P62 186268	C22-WRS3-MS1-K11-P65 186284	
	40° ▷◁ 40°	0	2 N/O			C22-WS3-MS1-K20-P62 186266	C22-WS3-MS1-K20-P65 186282	
	60° ▷◁ 60°	I 0 II				C22-WRS3-MS1-K20-P62 186269	C22-WRS3-MS1-K20-P65 186285	

Notes
¹⁾ ⊕ = Safety function implemented with positive opening as defined in IEC/EN 60947-5-1
²⁾ Contact sequence ■ = Contact closed □ = Contact open

C22 – Indicator lights

2

Connection type	Cable length m	Lens	LED	Contact sequence	Part no. Article no.	Std. pack
-----------------	-------------------	------	-----	------------------	-------------------------	-----------

Indicator lights

Flush
LED rated operating voltage: 24 V AC/DC
IP66, IP67, IP69K (at front), IP65 (at rear)

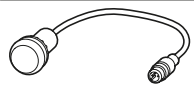

Cable (black) with M12A plug,
4 pole

0.2



C22-L-B-24-P1
185119

1 unit

C22-L-G-24-P1
185120



C22-L-R-24-P1
185121



C22-L-W-24-P1
185122



C22-L-Y-24-P1
185123



0.5



C22-L-B-24-P3
181619



C22-L-G-24-P3
181620



C22-L-R-24-P3
181621



C22-L-W-24-P3
181622



C22-L-Y-24-P3
181623

1



C22-L-B-24-P5
181137



C22-L-G-24-P5
181139



C22-L-R-24-P5
181141



C22-L-W-24-P5
181059



C22-L-Y-24-P5
181061



Cable (black) with M8 plug,
4 pole

0.2



C22-L-B-24-P30
185124

1 unit



C22-L-G-24-P30
185125



C22-L-R-24-P30
185126



C22-L-W-24-P30
185127



C22-L-Y-24-P30
185128

0.5



C22-L-B-24-P31
185129



C22-L-G-24-P31
185130



C22-L-R-24-P31
185131



C22-L-W-24-P31
185132



C22-L-Y-24-P31
185133

1



C22-L-B-24-P32
185134



C22-L-G-24-P32
185135



C22-L-R-24-P32
185136



C22-L-W-24-P32
185137



C22-L-Y-24-P32
185138

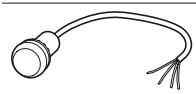

Connection type	Cable length m	Lens	LED	Contact sequence	Part no. Article no.	Std. pack
Indicator lights						
Cable (black) with unterminated end, 4 pole	1				C22-L-B-24-P62 185139	1 unit
					C22-L-G-24-P62 185140	
					C22-L-R-24-P62 185141	
					C22-L-W-24-P62 185142	
					C22-L-Y-24-P62 185143	
	3.5			C22-L-B-24-P65 185144		
				C22-L-G-24-P65 185145		
				C22-L-R-24-P65 185146		
				C22-L-W-24-P65 185147		
				C22-L-Y-24-P65 185148		

C22 – Illuminated pushbutton actuators

2

Cable length m	Button plate	LED	Contact configuration ¹⁾	Contact sequence	Contact diagram ²⁾	Momentary	Maintained	Std. pack
						Part no. Article no.	Part no. Article no.	

Illuminated pushbutton actuators

Silver bezel
LED rated operating voltage: 24 V AC/DC
IP66, IP67, IP69K (at front), IP65 (at rear)
Flush

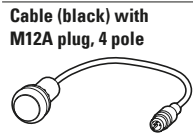

0.2	●●	●●	1 N/C	1 2 4 3		C22-DL-R-K10-24-P1 185555	C22-DRL-R-K10-24-P1 185559	1 unit
	●●	●●	1 N/O	1 2 4 3		C22-DL-B-K10-24-P1 185553	C22-DRL-B-K10-24-P1 185557	
	●●	●●	1 N/O	1 2 4 3		C22-DL-G-K10-24-P1 185554	C22-DRL-G-K10-24-P1 185558	
0.5	●●	●●	1 N/C	1 2 4 3		C22-DL-R-K01-24-P3 181626	C22-DRL-R-K01-24-P3 181630	
	●●	●●	1 N/O	1 2 4 3		C22-DL-B-K10-24-P3 181624	C22-DRL-B-K10-24-P3 181628	
	●●	●●	1 N/O	1 2 4 3		C22-DL-G-K10-24-P3 181625	C22-DRL-G-K10-24-P3 181629	
1	●●	●●	1 N/C	1 2 4 3		C22-DL-R-K01-24-P5 181303	C22-DRL-R-K01-24-P5 181368	
	●●	●●	1 N/O	1 2 4 3		C22-DL-B-K10-24-P5 181298	C22-DRL-B-K10-24-P5 181364	
	●●	●●	1 N/O	1 2 4 3		C22-DL-G-K10-24-P5 181300	C22-DRL-G-K10-24-P5 181366	

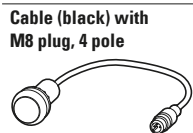

0.2	●●	●●	1 N/C	1 2 4 3		C22-DL-R-K01-24-P30 185563	C22-DRL-R-K01-24-P30 185567	1 unit
	●●	●●	1 N/O	1 2 4 3		C22-DL-B-K10-24-P30 185561	C22-DRL-B-K10-24-P30 185565	
	●●	●●	1 N/O	1 2 4 3		C22-DL-G-K10-24-P30 185562	C22-DRL-G-K10-24-P30 185566	
0.5	●●	●●	1 N/C	1 2 4 3		C22-DL-R-K01-24-P31 185571	C22-DRL-R-K01-24-P31 185575	
	●●	●●	1 N/O	1 2 4 3		C22-DL-B-K10-24-P31 185569	C22-DRL-B-K10-24-P31 185573	
	●●	●●	1 N/O	1 2 4 3		C22-DL-G-K10-24-P31 185570	C22-DRL-G-K10-24-P31 185574	
1	●●	●●	1 N/C	1 2 4 3		C22-DL-R-K01-24-P32 185579	C22-DRL-R-K01-24-P32 185583	
	●●	●●	1 N/O	1 2 4 3		C22-DL-B-K10-24-P32 185577	C22-DRL-B-K10-24-P32 185581	
	●●	●●	1 N/O	1 2 4 3		C22-DL-G-K10-24-P32 185578	C22-DRL-G-K10-24-P32 185582	

WWW.TM2A.PT info@tm2a.pt

WWW.TM2A.PT info@tm2a.pt

Cable length	Button plate	LED	Contact configuration ¹⁾	Contact sequence	Contact diagram ²⁾	Momentary Part no. Article no.	Maintained Part no. Article no.	Std. pack
m			N/O = Normally open contact N/C = Normally closed contact					

Illuminated pushbutton actuators

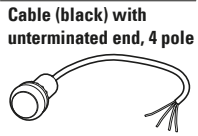

1	● ●	● ●	1 N/C ⊕			C22-DL-R-K10-24-P62 185587	C22-DRL-R-K10-24-P62 185591	1 unit
	● ●	● ●	1 N/O			C22-DL-B-K10-24-P62 185585	C22-DRL-B-K10-24-P62 185589	
	● ●	● ●				C22-DL-G-K10-24-P62 185586	C22-DRL-G-K10-24-P62 185590	
	○ ○	○ ○				C22-DL-W-K10-24-P62 185588	C22-DRL-W-K10-24-P62 185592	
3.5	● ●	● ●	1 N/C ⊕			C22-DL-R-K01-24-P65 185595	C22-DRL-R-K01-24-P65 185599	
	● ●	● ●	1 N/O			C22-DL-B-K10-24-P65 185593	C22-DRL-B-K10-24-P65 185597	
	● ●	● ●				C22-DL-G-K10-24-P65 185594	C22-DRL-G-K10-24-P65 185598	
	○ ○	○ ○				C22-DL-W-K10-24-P65 185596	C22-DRL-W-K10-24-P65 185600	

Notes
¹⁾ ⊕ = Safety function implemented with positive opening as defined in IEC/EN 60947-5-1
²⁾ Contact sequence: ■ = Contact closed □ = Contact open

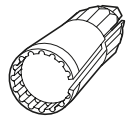

Mounting ring tool

For threaded ring; can be used with cordless screwdriver.

Part no.	Article no.	Std. pack
C22-MS	179955	1 unit

System overview

2

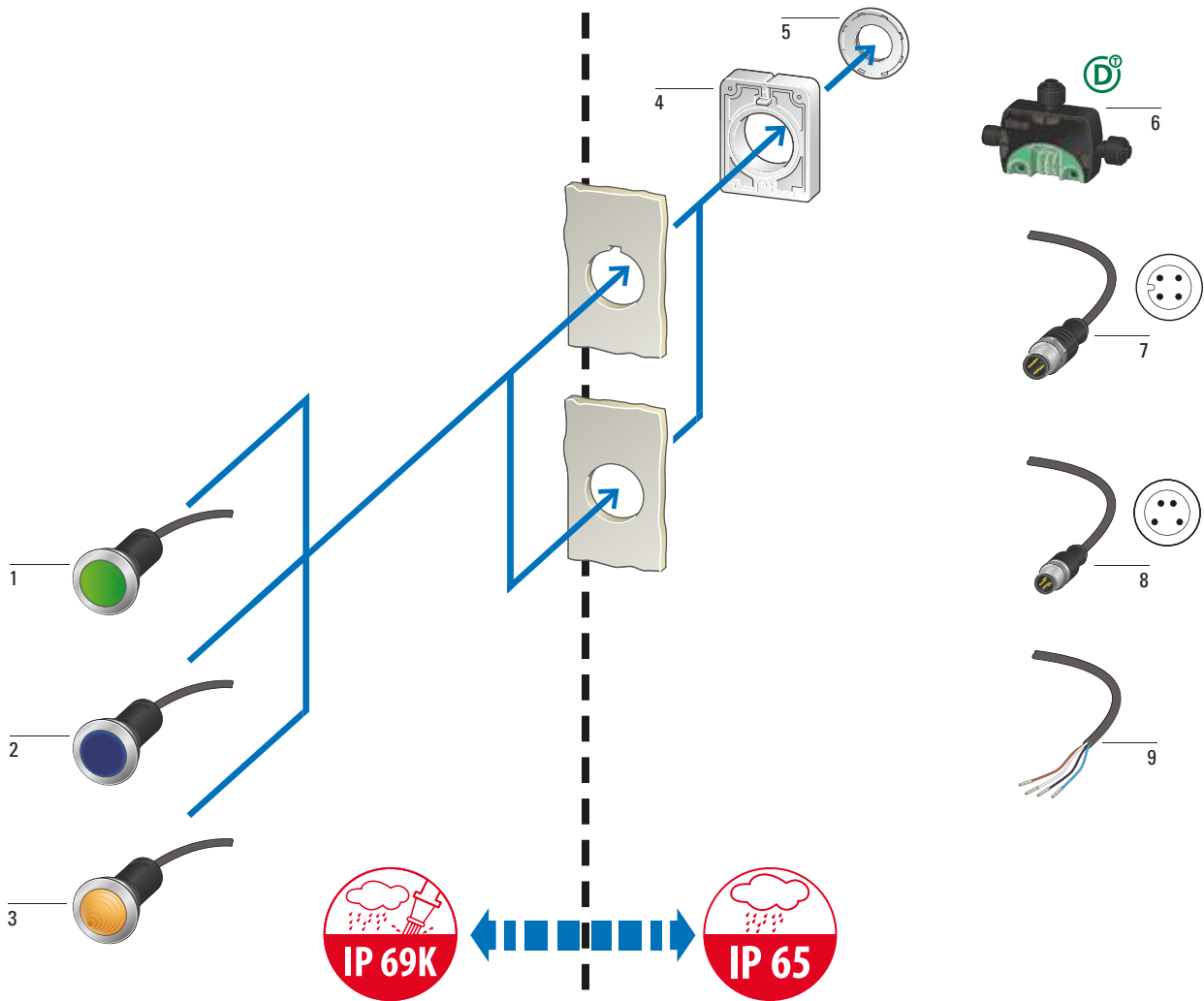

WWW.TM2A.PT info@tm2a.pt

WWW.TM2A.PT info@tm2a.pt

C30 pushbuttons	1
Momentary and maintained	
Flush	
Colors: white, green, red, black	
With cable (1.5 or 3 m) and plug (M12A or M8, 4 pole) or unterminated cable end (4 pole)	
→ Page 111	
C30 illuminated pushbutton actuators	2
Momentary and maintained	
Flush	
Colors: white, green, red, blue	
With cable (1.5 or 3 m) and plug (M12A or M8, 4 pole) or unterminated cable end (4 pole)	
24 V AC/DC	
→ Page 114	

C30 indicator lights	3
Flush	
Colors: white, green, red, blue, yellow	
With cable (1.5 or 3 m) and plug (M12A or M8, 4 pole) or unterminated cable end (4 pole)	
24 V AC/DC	
→ Page 113	
RMQ-AFX anti-rotation tab	4
Included with C30 compact devices	
Threaded rings	5
→ Page 70	

SmartWire-DT I/O module	6
For connecting digital input/output signals to SmartWire-DT	
IP67	
Cable with M12A plug, 4 pole	7
Cable with M8 plug, 4 pole	8
Cable end open, 4 pole	9

Product selection

Cable length	Button plate	Contact configuration ¹⁾	Contact sequence ²⁾	Contact diagram	Momentary Part no. Article no.	Maintained Part no. Article no.	Std. pack
m		N/O = Normally open contact	N/C = Normally closed contact				

Pushbuttons

30 mm Flat Front
Metal bezel
IP66, IP67, IP69K (at front), IP65 (at rear)
Flush

Cable (black) with
M12A plug, 4 pole

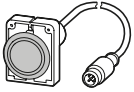

1		1 N/C ⊕			Zw = 4.5 mm	C30C-FD-R-K01-P5 185987	C30C-FDR-R-K01-P5 185996	1 unit
						C30C-FD-S-K01-P5 185985	C30C-FDR-S-K01-P5 185994	
	Without button plate					C30C-FD-X-K01-P5 185989	C30C-FDR-X-K01-P5 185998	
		1 N/O			C30C-FD-G-K10-P5 185988	C30C-FDR-G-K10-P5 185997		
					C30C-FD-W-K10-P5 185986	C30C-FDR-W-K10-P5 185995		
	Without button plate				C30C-FD-X-K10-P5 185990	C30C-FDR-X-K10-P5 185999		

Cable (black) with
M8 plug, 4 pole

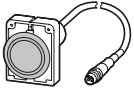

1		1 N/C ⊕			Zw = 4.5 mm	C30C-FD-R-K01-P32 186018	C30C-FDR-R-K01-P32 186027	1 unit
						C30C-FD-S-K01-P32 186016	C30C-FDR-S-K01-P32 186025	
	Without button plate					C30C-FD-X-K01-P32 186020	C30C-FDR-X-K01-P32 186029	
		1 N/O			C30C-FD-G-K10-P32 186019	C30C-FDR-G-K10-P32 186028		
					C30C-FD-W-K10-P32 186017	C30C-FDR-W-K10-P32 186026		
	Without button plate				C30C-FD-X-K10-P32 186021	C30C-FDR-X-K10-P32 186030		

Notes

¹⁾ ⊕ = Safety function implemented with positive opening as defined in IEC/EN 60947-5-1

²⁾ Contact sequence: = Contact closed = Contact open

Cable length m	Button plate	Contact configuration ¹⁾		Contact sequence ²⁾	Contact diagram	Momentary		Maintained		Std. pack
		N/O = Normally open contact	N/C = Normally closed contact			Part no. Article no.	Part no. Article no.			

Pushbuttons







Cable (black) with unterminated end, 4 pole



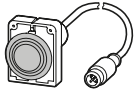

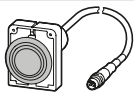





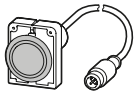







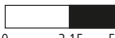



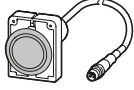



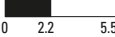



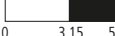



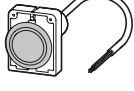



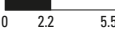



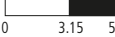





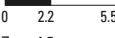

1		1 N/C ⊕				C30C-FD-R-K01-P62 186049	C30C-FDR-R-K01-P62 186058	1 unit	
		1 N/O				C30C-FD-S-K01-P62 186047	C30C-FDR-S-K01-P62 186056		
	Without button plate		2 N/C ⊕				C30C-FD-X-K01-P62 186051		C30C-FDR-X-K01-P62 186060
	Without button plate		1 N/O				C30C-FD-X-K02-P62 186055		C30C-FDR-X-K02-P62 186064
	Without button plate		1 N/C ⊕				C30C-FD-X-K11-P62 186053		C30C-FDR-X-K11-P62 186062
	Without button plate		1 N/O				C30C-FD-G-K10-P62 186050		C30C-FDR-G-K10-P62 186059
Without button plate		2 N/O				C30C-FD-W-K10-P62 186048	C30C-FDR-W-K10-P62 186057		
Without button plate		1 N/O				C30C-FD-X-K10-P62 186052	C30C-FDR-X-K10-P62 186061		
Without button plate		2 N/O				C30C-FD-X-K20-P62 186054	C30C-FDR-X-K20-P62 186063		
Without button plate		1 N/C ⊕				C30C-FD-R-K01-P65 185960	C30C-FDR-R-K01-P65 185969		
3.5		1 N/C ⊕				C30C-FD-S-K01-P65 185958	C30C-FDR-S-K01-P65 185967		
		1 N/O				C30C-FD-X-K01-P65 185962	C30C-FDR-X-K01-P65 185971		
	Without button plate		2 N/C ⊕				C30C-FD-X-K02-P65 185966	C30C-FDR-X-K02-P65 185975	
	Without button plate		1 N/O				C30C-FD-X-K11-P65 185964	C30C-FDR-X-K11-P65 185973	
	Without button plate		1 N/C ⊕				C30C-FD-G-K10-P65 185961	C30C-FDR-G-K10-P65 185970	
	Without button plate		1 N/O				C30C-FD-W-K10-P65 185959	C30C-FDR-W-K10-P65 185968	
Without button plate		2 N/O				C30C-FD-X-K10-P65 185963	C30C-FDR-X-K10-P65 185972		
Without button plate		1 N/O				C30C-FD-X-K20-P65 185965	C30C-FDR-X-K20-P65 185974		

Notes

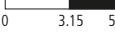
- ¹⁾ ⊕ = Safety function implemented with positive opening as defined in IEC/EN 60947-5-1
²⁾ Contact sequence: ■ = Contact closed □ = Contact open

Connection type	Cable length m	Lens	LED	Contact sequence	Part no. Article no.	Std. pack
Indicator lights						
30 mm Flat Front Metal bezel LED rated operating voltage: 24 V AC/DC IP66, IP67, IP69K (at front), IP65 (at rear)						
	1	Blue	Blue		C30C-FL-B-24-P5 186013	1 unit
		Green	Green		C30C-FL-G-24-P5 186012	
		Red	Red		C30C-FL-R-24-P5 186011	
		White	White		C30C-FL-W-24-P5 186015	
		Yellow	White		C30C-FL-Y-24-P5 186014	
	1	Blue	Blue		C30C-FL-B-24-P32 186044	1 unit
		Green	Green		C30C-FL-G-24-P32 186043	
		Red	Red		C30C-FL-R-24-P32 186042	
		White	White		C30C-FL-W-24-P32 186046	
		Yellow	White		C30C-FL-Y-24-P32 186045	
	1	Blue	Blue		C30C-FL-B-24-P62 185955	1 unit
		Green	Green		C30C-FL-G-24-P62 185954	
		Red	Red		C30C-FL-R-24-P62 185953	
		White	White		C30C-FL-W-24-P62 185957	
		Yellow	White		C30C-FL-Y-24-P62 185956	
	3.5	Blue	Blue	C30C-FL-B-24-P65 186070		
		Green	Green	C30C-FL-G-24-P65 186069		
		Red	Red	C30C-FL-R-24-P65 185984		
		White	White	C30C-FL-W-24-P65 186072		
		Yellow	White	C30C-FL-Y-24-P65 186071		

Cable length	Button plate	LED	Contact configuration ¹⁾	Contact sequence	Contact diagram ²⁾	Part no. Article no.	Momentary	Maintained	Std. pack
Illuminated pushbutton actuators									
30 mm Flat Front Metal bezel LED rated operating voltage: 24 V AC/DC IP66, IP67, IP69K (at front), IP65 (at rear) Flush									
Cable (black) with M12A plug, 4 pole 	1	 	1 N/C ⊕		 Zw = 4.5 mm	C30C-FDL-R-K01-24-P5 186004		C30C-FDRL-R-K01-24-P5 186008	1 unit
		 	1 N/O			C30C-FDL-B-K10-24-P5 186006		C30C-FDRL-B-K10-24-P5 186010	
		 				C30C-FDL-G-K10-24-P5 186005		C30C-FDRL-G-K10-24-P5 186009	
		 				C30C-FDL-W-K10-24-P5 186003		C30C-FDRL-W-K10-24-P5 186007	
Cable (black) with M8 plug, 4 pole 	1	 	1 N/C ⊕		 Zw = 4.5 mm	C30C-FDL-R-K01-24-P32 186035		C30C-FDRL-R-K01-24-P32 186039	1 unit
		 	1 N/O			C30C-FDL-B-K10-24-P32 186037		C30C-FDRL-B-K10-24-P32 186041	
		 				C30C-FDL-G-K10-24-P32 186036		C30C-FDRL-G-K10-24-P32 186040	
		 				C30C-FDL-W-K10-24-P32 186034		C30C-FDRL-W-K10-24-P32 186038	
Cable (black) with unterminated end, 4 pole 	1	 	1 N/C ⊕		 Zw = 4.5 mm	C30C-FDL-R-K01-24-P62 186066		C30C-FDRL-R-K01-24-P62 185950	1 unit
		 	1 N/O			C30C-FDL-B-K10-24-P62 186068		C30C-FDRL-B-K10-24-P62 185952	
		 				C30C-FDL-G-K10-24-P62 186067		C30C-FDRL-G-K10-24-P62 185951	
		 				C30C-FDL-W-K10-24-P62 186065		C30C-FDRL-W-K10-24-P62 185949	
	3.5	 	1 N/C ⊕		 Zw = 4.5 mm	C30C-FDL-R-K01-24-P65 185977		C30C-FDRL-R-K01-24-P65 185981	
		 	1 N/O			C30C-FDL-B-K10-24-P65 185979		C30C-FDRL-B-K10-24-P65 185983	
	 				C30C-FDL-G-K10-24-P65 185978		C30C-FDRL-G-K10-24-P65 185982		
	 				C30C-FDL-W-K10-24-P65 185976		C30C-FDRL-W-K10-24-P65 185980		

Notes ¹⁾ ⊕ = Safety function implemented with positive opening as defined in IEC/EN 60947-5-1
²⁾ Contact sequence: ■ = Contact closed □ = Contact open

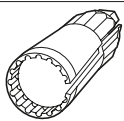

Mounting ring tool

For threaded ring; can be used with cordless screwdriver.

Part no. Article no.	Std. pack
C22-MS 179955	1 unit

Technical data

			Controlled stop/ emergency switching off buttons	(Illuminated) pushbuttons Momentary/ maintained	Selector switches	Key-operated buttons	Indicator lights
General							
Standards			IEC/EN 60947-5-5 VDE 0660	IEC/EN 60947-5-1 VDE 0660	IEC/EN 60947-5-1 VDE 0660	IEC/EN 60947-5-1 VDE 0660	IEC/EN 60947-5-1 VDE 0660
Lifespan, mechanical	Operations	x 10 ⁶	0.05	5/1	1	0.1	–
Operating frequency	Operations/h		300	3600	2000	100	–
Operating force	N		50	5	–	–	–
Operating torque	Nm		–	–	0.3	0.5	–
Plug tightening torque	Nm		M12 = 1, M8 = 0.6	M12 = 1, M8 = 0.6	M12 = 1, M8 = 0.6	M12 = 1, M8 = 0.6	M12 = 1, M8 = 0.6
Threaded ring tightening torque	Nm		2	2	2	2	2
Climatic proofing							
Damp heat, constant			As defined in IEC 60068-2-78	As defined in IEC 60068-2-78	As defined in IEC 60068-2-78	As defined in IEC 60068-2-78	As defined in IEC 60068-2-78
Damp heat, cyclic			As defined in IEC 60068-2-30	As defined in IEC 60068-2-30	As defined in IEC 60068-2-30	As defined in IEC 60068-2-30	As defined in IEC 60068-2-30
Degree of protection			IP66, IP67, IP69K (at front) IP65 (at rear)	IP66, IP67, IP69K (at front) IP65 (at rear)	IP66 (at front) IP65 (at rear)	IP66 (at front) IP65 (at rear)	IP66, IP67, IP69K (at front) IP65 (at rear)
Ambient air temperature							
Open			°C -25 - +70	-25 - +70	-25 - +70	-25 - +70	-25 - +70
Storage			°C -30 - +80	-30 - +80	-30 - +80	-30 - +80	-30 - +80
Mounting position			Any	Any	Any	Any	Any
Mechanical shock resistance for a shock duration of 11 ms			g > 30	> 30	> 30	> 30	> 30
Contacts							
Rated impulse withstand voltage	U _{imp}	V AC	M12A/unterminated: 4000 M8: 800	M12A/unterminated: 4000 M8: 800	M12A/unterminated: 4000 M8: 800	M12A/unterminated: 4000 M8: 800	M12A/unterminated: 4000 M8: 800
Rated insulation voltage	U _i	V	M12A/unterminated: 250 M8: 30	M12A/unterminated: 250 M8: 30	M12A/unterminated: 250 M8: 30	M12A/unterminated: 250 M8: 30	M12A/unterminated: 250 M8: 30
Overvoltage category/ degree of pollution			III/3	III/3	III/3	III/3	III/3
Control circuit reliability at 17 V DC/7 mA			HF				
N/O (statistically determined)			1 failure per 17 x 10 ⁶ operations	1 failure per 17 x 10 ⁶ operations	1 failure per 17 x 10 ⁶ operations	1 failure per 17 x 10 ⁶ operations	–
N/C (statistically determined)			1 failure per 0.9 x 10 ⁶ operations	1 failure per 0.9 x 10 ⁶ operations	1 failure per 0.9 x 10 ⁶ operations	1 failure per 0.9 x 10 ⁶ operations	–
Fuse	gG/gL	A	4	4	4	4	4
Conditional short-circuit current	I _q	kA	1	1	1	1	1
Switching capacity							
Rated operational current			I _e A				
AC-15: 24 V			I _e A	4	4	4	–
DC-13: 24 V			I _e A	3	3	3	–
Cable characteristics							
Versions			M12A/ unterminated	M12A/M8/ unterminated	M12A/M8/ unterminated	M12A/M8/ unterminated	M12A/M8/ unterminated
Material			PUR	PUR	PUR	PUR	PUR
Diameter			∅ mm	4.7	4.7	4.7	4.7
Actuator travel and actuation force as per DIN EN 60947-5-1, K.5.4.1							
Positive opening sequence			mm	4.65	4.65	4.65	–
Maximum travel			mm	5.11	5.7	5.7	–
Minimum force for positive opening			N	K01 = 15/K11 = 20/K02 = 34	K01 = 15/K11 = 20/K02 = 30	K01 = 15/K11 = 20/K02 = 35	K01 = 15/K11 = 20/K02 = 36

Dimensions

2

Pushbuttons, M12A

C22-D...-P1/-P3/-P5

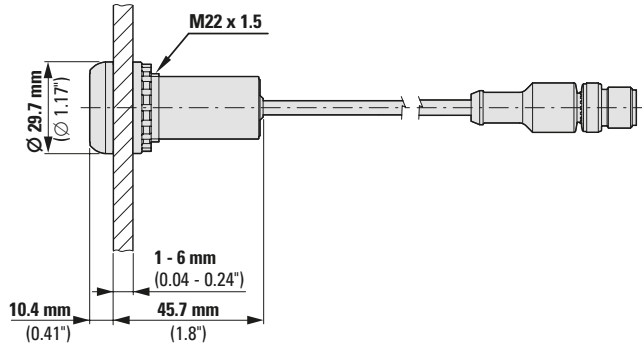

Pushbuttons, M8

C22-D...-P30/-P31/-P32

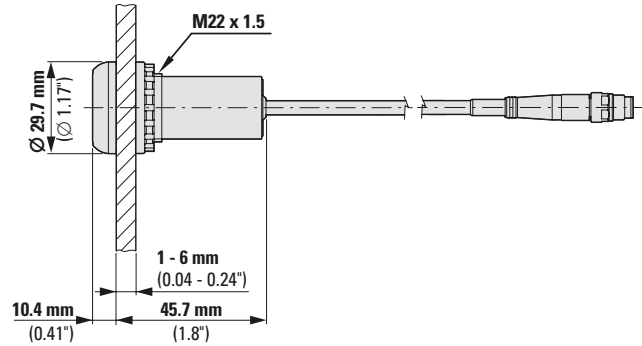

Pushbuttons, unterminated cable end

C22-D...-P/-P62/-P65

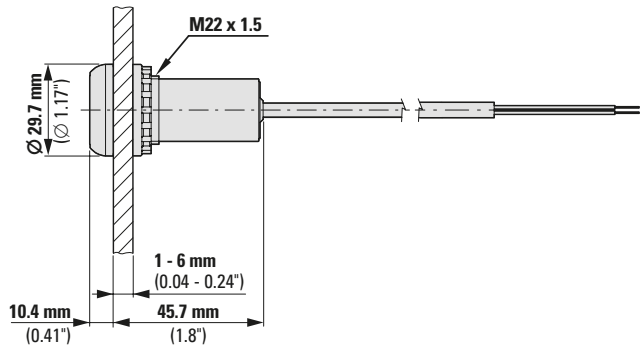

Indicator lights, M12A

C22-L...-P1/-P3/-P5

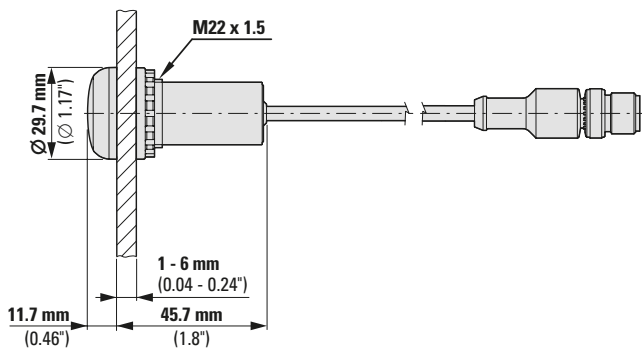

Indicator lights, M8

C22-L...-P30/-P31/-P32

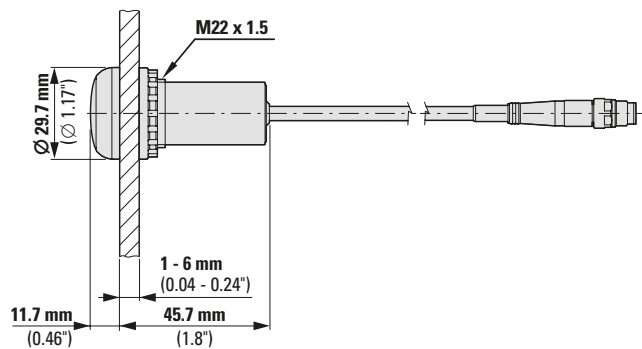

Indicator lights, unterminated cable end

C22-L...-P62/-P65

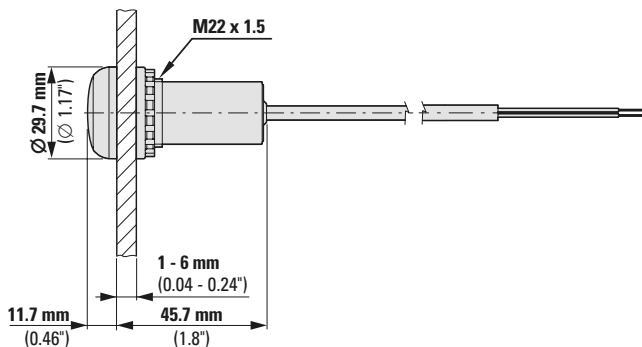

WWW.TM2A.PT info@tm2a.pt

WWW.TM2A.PT info@tm2a.pt

Emergency switching off, M12A

C22-PVT...-P10

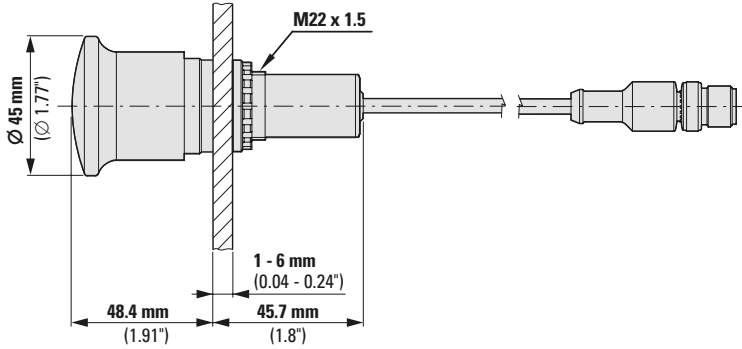

Emergency switching off, unterminated cable end

C22-PVT...-P62/-P65

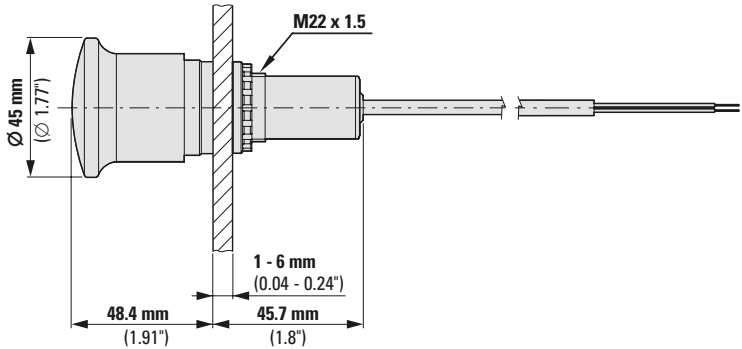

Emergency switching off, M12A

C22-PV...-P10

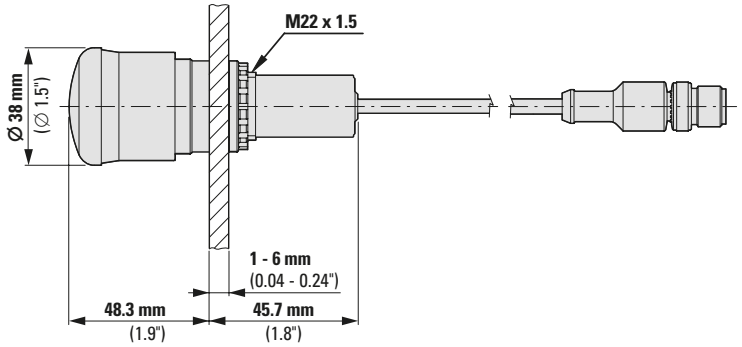

Emergency switching off, unterminated cable end

C22-PV...-P62/-P65

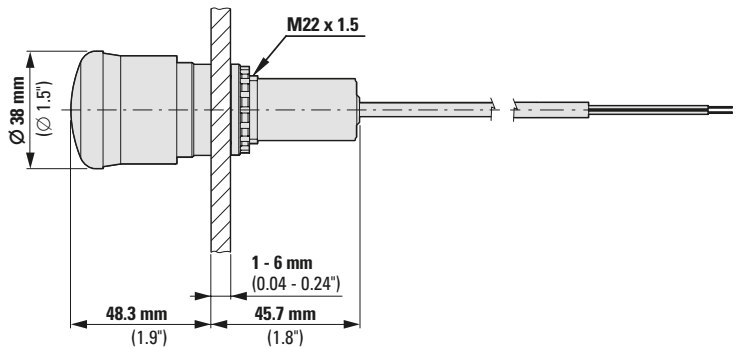

WWW.TM2A.PT info@tm2a.pt

WWW.TM2A.PT info@tm2a.pt

Key-operated buttons, M12A

C22-W(R)S(3)-MS1-...-P1/-P5

2

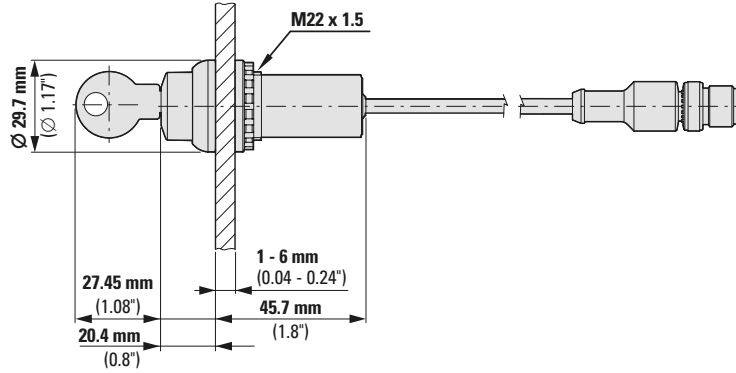

Key-operated buttons, M8

C22-W(R)S(3)-MS1-...-P30/-P32

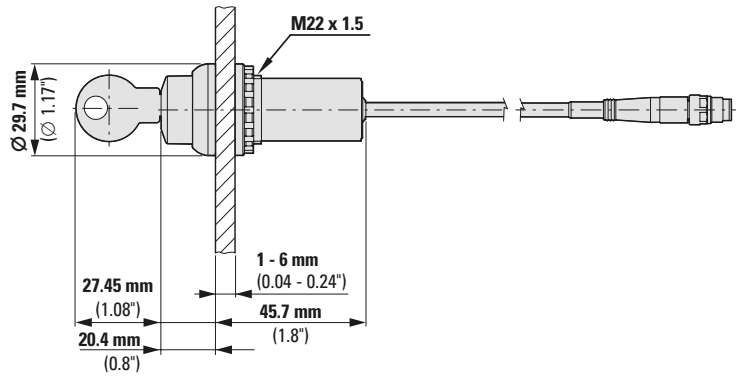

Key-operated buttons, unterminated cable end

C22-W(R)S(3)-MS1-...-P62/-P65

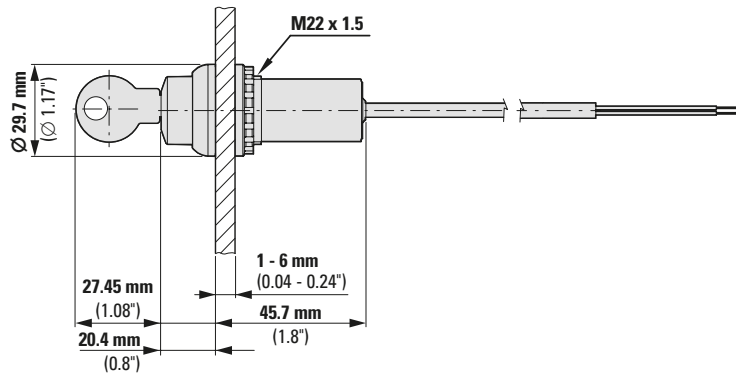

WWW.TM2A.PT info@tm2a.pt

WWW.TM2A.PT info@tm2a.pt

Selector switches, M12A

C22-W(R)K(3)-...-P1/-P5

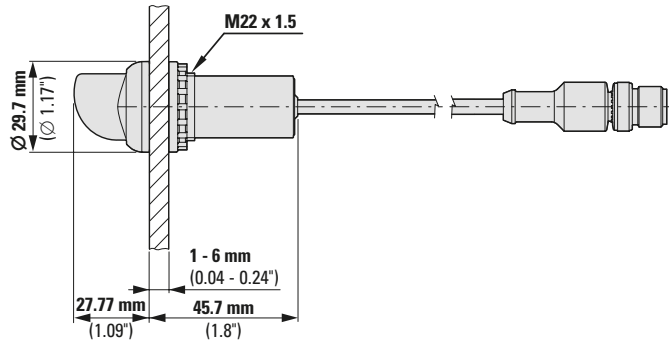

Selector switches, M8

C22-W(R)K(3)-...-P30/-P32

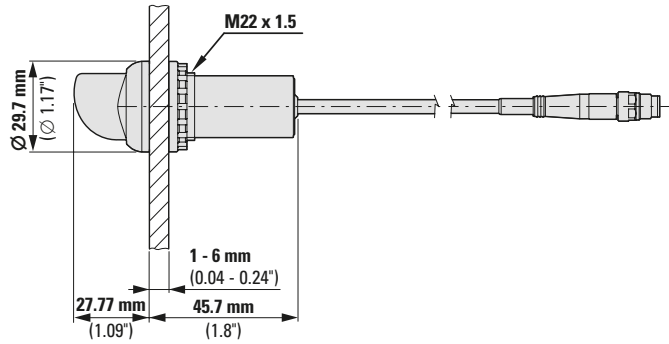

Selector switches, unterminated cable end

C22-W(R)K(3)-...-P62/-P65

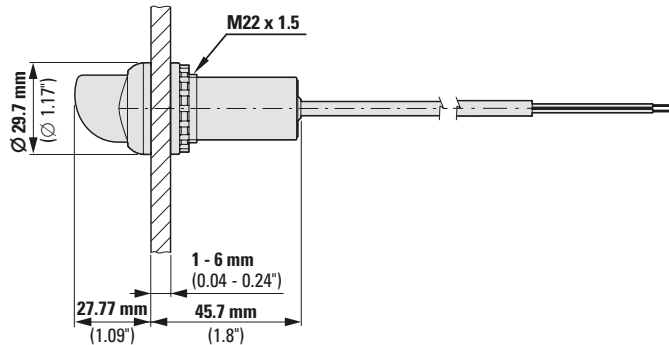

WWW.TM2A.PT info@tm2a.pt

WWW.TM2A.PT info@tm2a.pt

2.6

RMQ compact solution

C30 – Dimensions

Moeller series

Pushbuttons, M12A

C30C-FD(R)(L)-...-P5

2

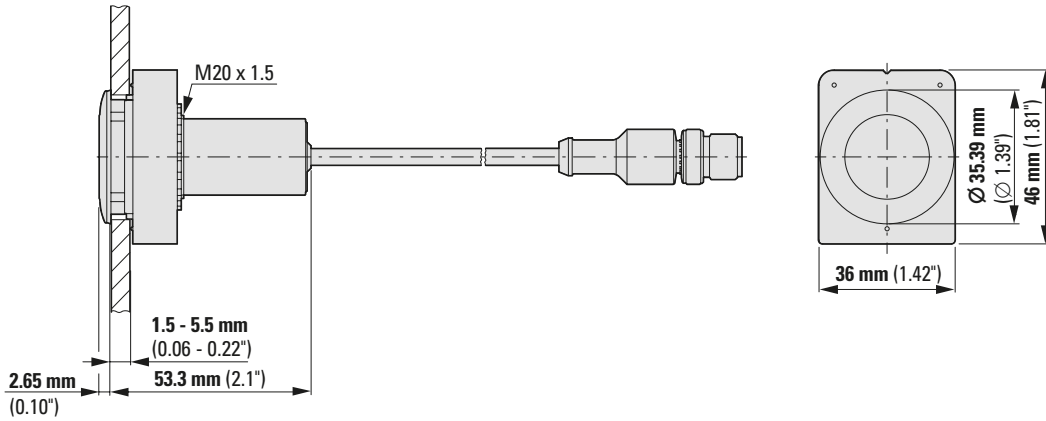

Pushbuttons, M8

C30C-FD(R)(L)-...-P32

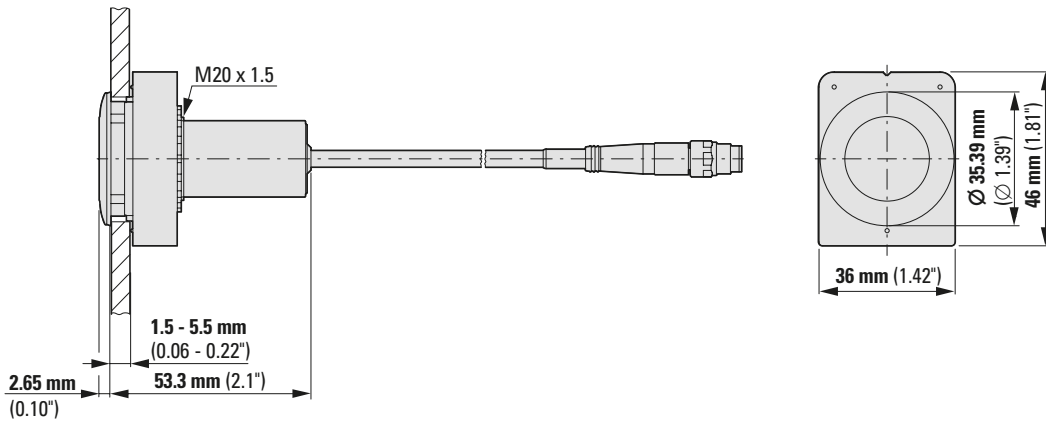

Pushbuttons, unterminated cable end

C30C-FD(R)(L)-...-P62/-65

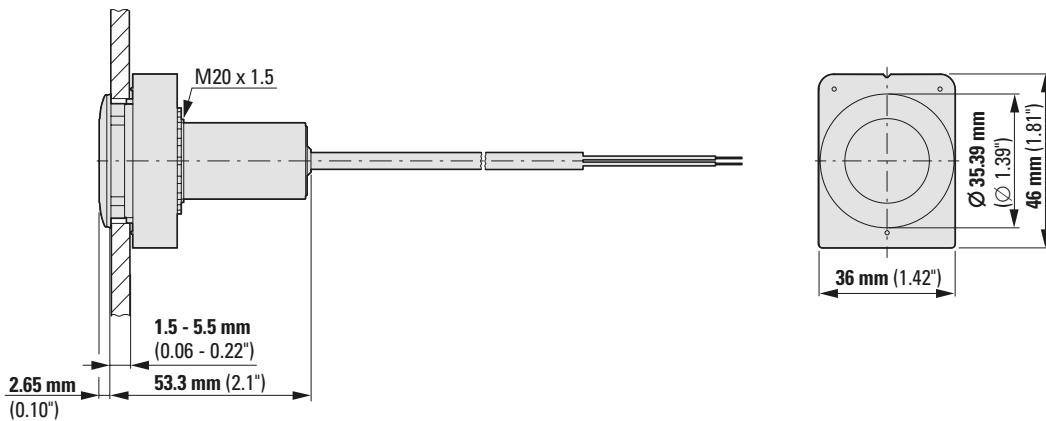

Indicator lights, M12A

C30C-FL-...-P5

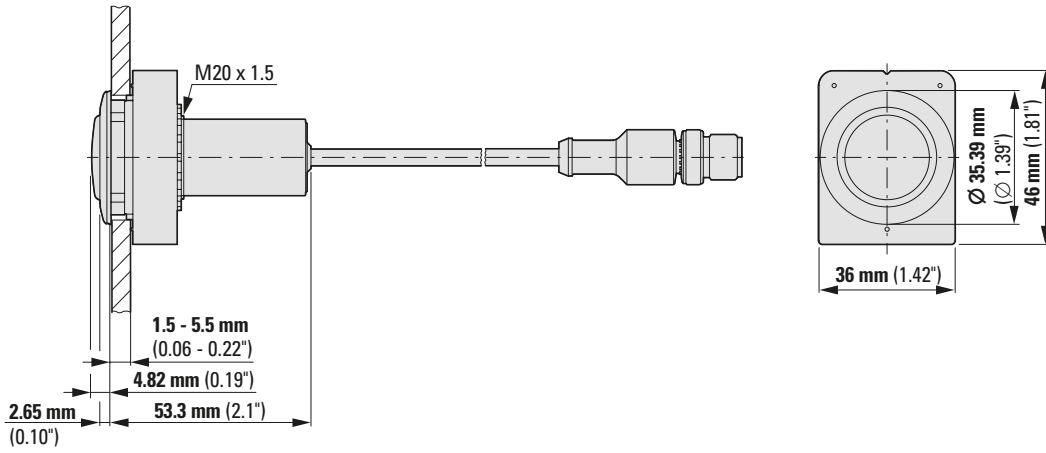

Indicator lights, M8

C30C-FL-...-P32

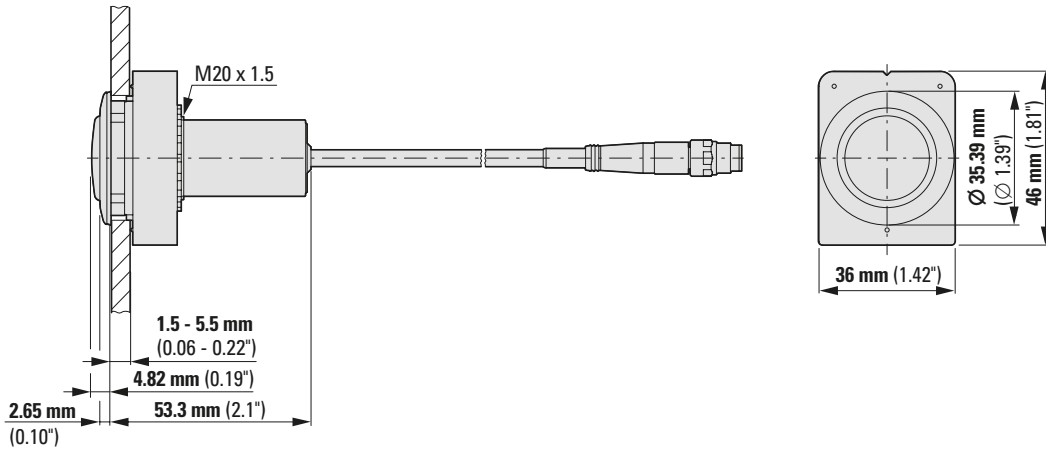

Indicator lights, unterminated cable end

C30C-FL-...-24-P62/-P65

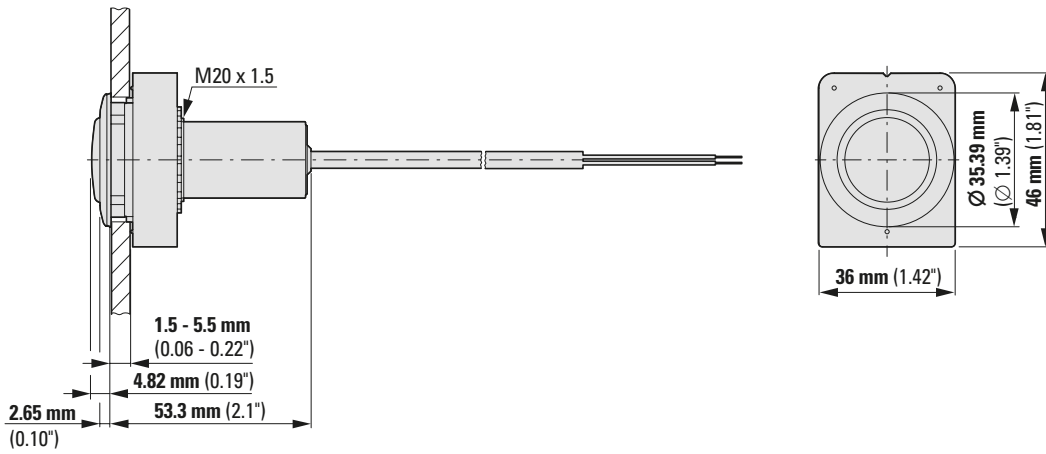

Build it in.

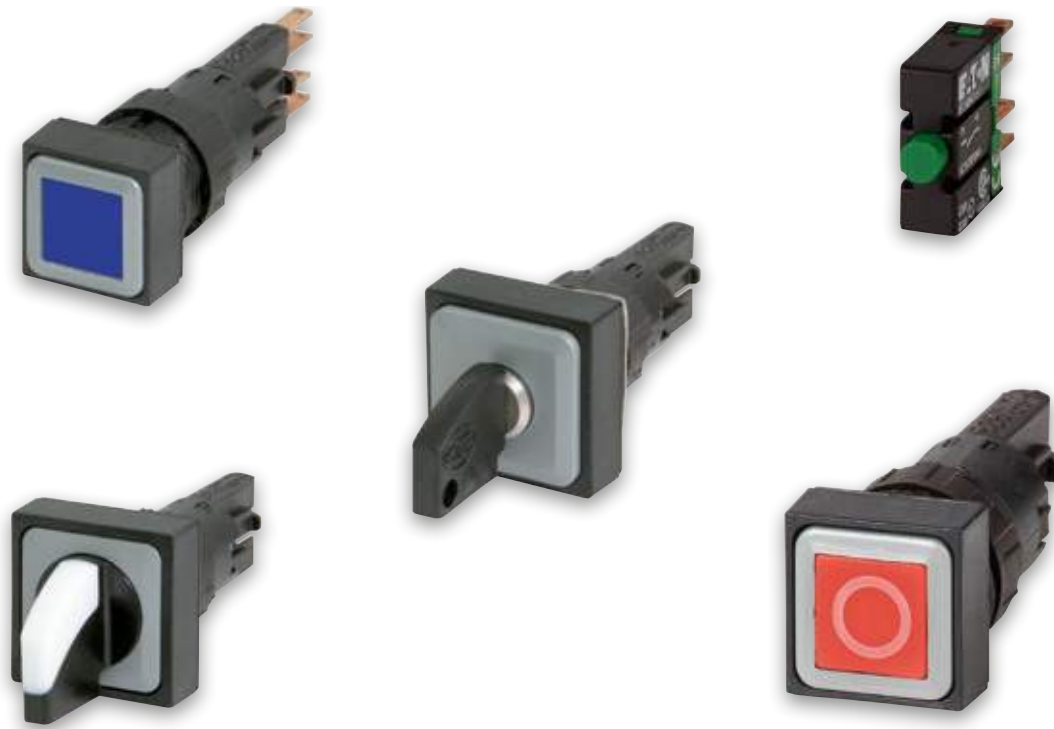

The RMQ16 Series Squeezes Signaling and Control into a Tiny Space



www.eaton.eu/rmq16

Square RMQ16 pilot devices with sizes of 18 mm and 25 mm are the perfect solution for control interfaces where space is at a premium. The various front elements can be installed with a perfect fit in any of their possible four directions and, thanks to their IP65 degree of protection in the front, are the perfect choice for safe use in harsh conditions. The series is not only characterized by a wide range of indicator lights, pushbuttons, selector switches, and key-operated switches, but its label editor function within the Pushbutton-Configurator also makes it possible to get customized laser inscriptions. The LED lamps and the contact elements in the series are connected using 2.8 mm x 0.8 mm female push-on connectors.

RMQ16 emergency stop buttons are tamper-proof in compliance with ISO 13850 / EN 418 and have a pull-to-reset mechanism. They can also be used as emergency switching off buttons.

RMQ16



3.0 RMQ16 Pilot devices	
3.1 System overview	
System overview	124
3.2 Product selection	
Pushbuttons	126
Illuminated pushbutton actuators	127
Changeover switches	128
Illuminated selector switch actuators	129
Key-operated actuators	130
Indicator lights	131
Emergency-Stop pushbuttons, Emergency-Stop labels	132
Accessories	133
3.3 Technical data	
Technical data	140
3.4 Dimensions	
Dimensions	142

3

Product features

- Front dimension and minimum grid dimensions 18 x 18 mm or 25 x 25 mm
- Mounting hole diameter 16.2 mm to EN 50007
- Degree of protection IP65
- For switching differing potentials
- Suitable for use with electronic devices to IEC/EN 61131-2
- Technical data according to IEC/EN 60947-5-1
- Approved throughout the world

3.1

RMQ16 Pilot devices

System overview

Moeller series

System overview

3

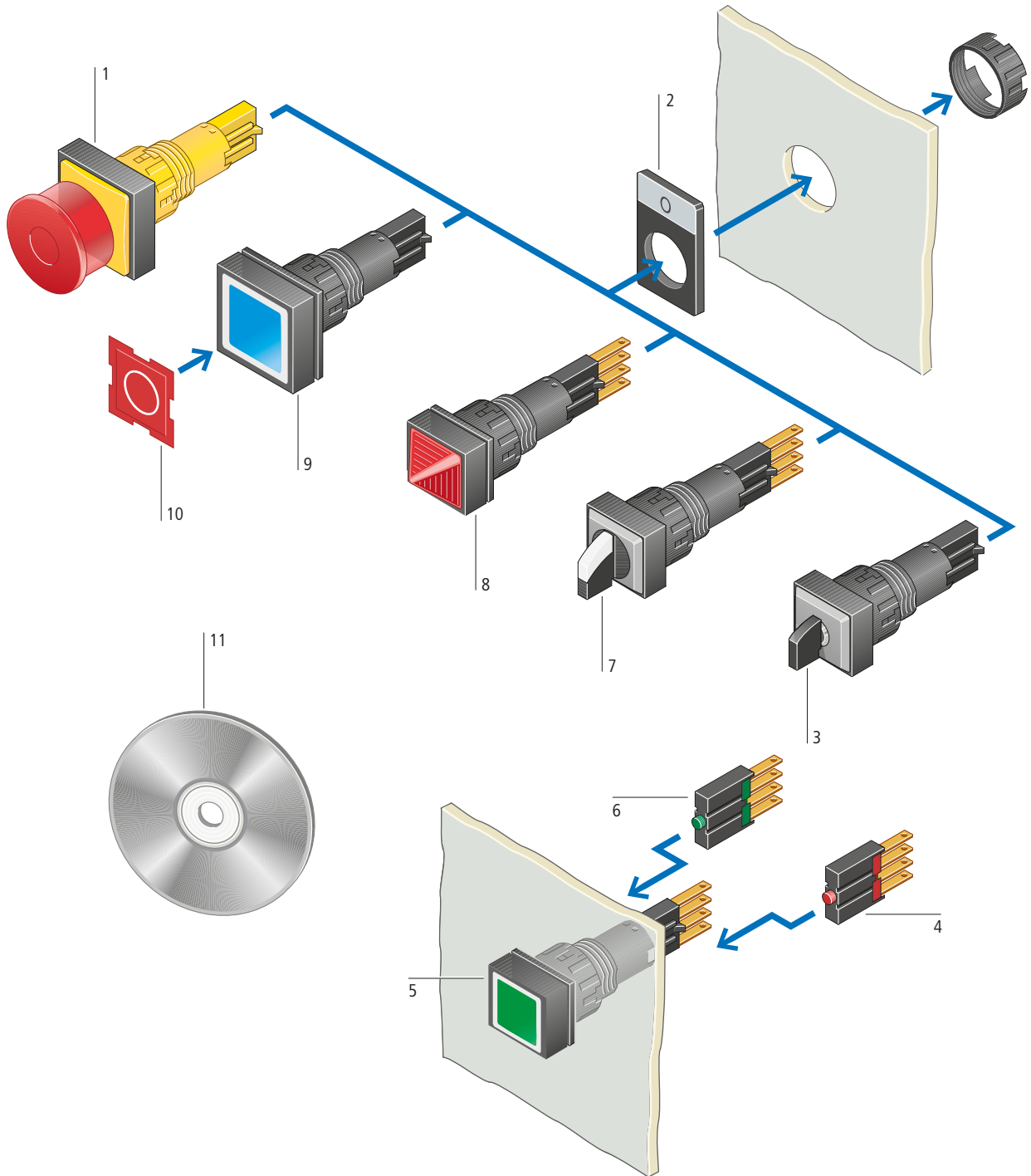

WWW.TM2A.PT info@tm2a.pt

WWW.TM2A.PT info@tm2a.pt

<p>Emergency-stop pushbuttons 1</p> <p>Can also be used as emergency switching off devices</p> <p>Tamper-proof according to ISO 13850/EN 418</p> <p>Illuminated and non-illuminated</p> <p>Additional labels, inscribed or blank</p> <p>European Machinery Safety Directive 2006/42/EC</p> <p>→ Page 132</p> <hr/> <p>Label mounts 2</p> <p>For insert labels</p> <p>Color: light grey, black, yellow</p> <p>Insert labels, inscribed or blank</p> <p>→ Page 137</p> <hr/> <p>Key-operated actuator 3</p> <p>2 and 3 positions</p> <p>Switching angle 45°</p> <p>Momentary and maintained</p> <p>Various lock mechanisms</p> <p>→ Page 130</p> <hr/> <p>Break contact element (red) 4</p> <p>With blade terminal</p> <p>Universal contacts suitable for use with electronic devices</p> <p>Positive opening safety function according to IEC/EN 60947-5-1</p> <p>→ Page 126</p>	<p>Illuminated pushbutton actuators 5</p> <p>Momentary and maintained</p> <p>Replaceable insert labels</p> <p>Colors: white, green, red, yellow, blue custom laser inscription</p> <p>→ Page 127</p> <hr/> <p>Make contact element (green) 6</p> <p>With blade terminal</p> <p>Universal contacts suitable for use with electronic devices</p> <p>→ Page 126</p> <hr/> <p>Changeover switches 7</p> <p>2 and 3 positions</p> <p>Switching angle 45° momentary and maintained</p> <p>Illuminated selector switch actuators with built-in lamp socket</p> <p>Colors: white, green, red</p> <p>→ Page 128</p> <hr/> <p>Indicator lights 8</p> <p>Flush and conical designs</p> <p>Built-in lamp socket</p> <p>For filament lamps and LEDs</p> <p>Colors: white, green, red, yellow, blue custom laser inscription</p> <p>→ Page 131</p>	<p>Pushbuttons 9</p> <p>Momentary and maintained</p> <p>Replaceable button plates</p> <p>Colors: white, green, red, yellow, blue, black</p> <p>→ Page 126</p> <hr/> <p>Button plates/insert labels 10</p> <p>Wear-resistant button plates for pushbutton actuators</p> <p>Transparent insert plates for illuminated pushbuttons and indicator lights</p> <p>Inscribed or blank</p> <p>With standard text and symbols or with custom laser inscription</p> <p>→ Page 133</p> <hr/> <p>Labelling with convenience 11</p> <p>All button plates, indicator lights and additional button plates from the RMQ range can be laser inscribed with any text and symbol as required.</p> <p>Download: www.eaton.eu/config/rmq Key word: „Pushbutton-Configurator → Labeleditor Function“</p>
---	--	---

Product selection

3



Front dimensions
18 x 18 mm

Front dimensions
25 x 25 mm

Color **Part no.** **Part no.** Std. pack
Button plate Article no. Article no.

Pushbuttons, IP65

momentary

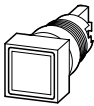

	green	Q18D-11 086332	Q25D-11 090471	10 off
	red	Q18D-10 086299	Q25D-10 090421	
	white	Q18D-20 054041	Q25D-20 054038	
	black	Q18D-19 054040	Q25D-19 054039	
	black	Q18D-SW 086788	Q25D-SW 087230	
	white	Q18D-WS 086752	Q25D-WS 086808	
	green	Q18D-GN 086450	Q25D-GN 086409	
	red	Q18D-RT 086713	Q25D-RT 086444	
	yellow	Q18D-GE 086417	Q25D-GE 086343	
	blue	Q18D-BL 086384	Q25D-BL 086328	
-	none	Q18D-X 093623	Q25D-X 093624	

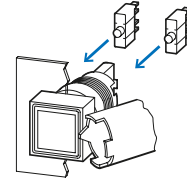

Accessories

Assembly aids and accessories

Contact elements

N/O Contact

N/C contact

Page

→ 138

→ 126

→ 126

maintained

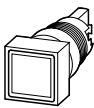

	black	Q18DR-SW 086269	Q25DR-SW 088739	10 off
	white	Q18DR-WS 086243	Q25DR-WS 088701	
	green	Q18DR-GN 086176	Q25DR-GN 088531	
	red	Q18DR-RT 086209	Q25DR-RT 088627	
	yellow	Q18DR-GE 090482	Q25DR-GE 088404	
	blue	Q18DR-BL 090241	Q25DR-BL 088110	
-	none	Q18DR-X 093625	Q25DR-X 093626	

Contact configuration:

⊕ = Safety function by positive opening according to IEC/EN 60947-5-1

N/O = normally open contact

N/C = normally closed contact

Contact sequence

Contact diagram

Color

Part no.
Article no.

Std. pack

Contact blocks

Operational voltage: 5 - 250 V

1 N/O	-				E10 090351	50 off
-	1 N/C ⊕				E01 090401	50 off

Notes

$\begin{matrix} | \\ \text{xy} \\ | \end{matrix}$ x = Sequence number on front element
y = Function number on contact element



Front dimensions
18 x 18 mm

Front dimensions
25 x 25 mm

Color Part no. Article no. Part no. Article no. Std. pack

Illuminated pushbuttons, IP65

momentary
Without filament
lamp

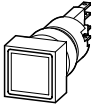

	–	Q18LT-WS 089202	Q25LT-WS 086262	10 off
	–	Q18LT-GN 089067	Q25LT-GN 086206	
	–	Q18LT-RT 089776	Q25LT-RT 086238	
	–	Q18LT-GE 088808	Q25LT-GE 086173	
	–	Q18LT-BL 088764	Q25LT-BL 090479	
–	Without lens	Q18LT-X 051745	Q25LT-X 051746	

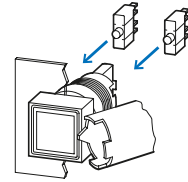

Accessories	Page
Assembly aids and accessories	→ 138
Contact elements	
N/O Contact	→ 126
N/C contact	→ 126

momentary
With filament
lamp, 24 V

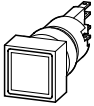

	–	Q18LT-WS/WB 088561	Q25LT-WS/WB 090226	10 off
	–	Q18LT-GN/WB 088509	Q25LT-GN/WB 089190	
	–	Q18LT-RT/WB 088537	Q25LT-RT/WB 089998	
	–	Q18LT-GE/WB 088449	Q25LT-GE/WB 089137	
	–	Q18LT-BL/WB 088338	Q25LT-BL/WB 089102	

maintained
Without filament
lamp

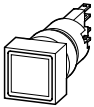

	–	Q18LTR-WS 088123	Q25LTR-WS 087232	10 off
	–	Q18LTR-GN 087831	Q25LTR-GN 086812	
	–	Q18LTR-RT 087918	Q25LTR-RT 086840	
	–	Q18LTR-GE 087764	Q25LTR-GE 086784	
	–	Q18LTR-BL 086813	Q25LTR-BL 086739	
–	Without lens	Q18LTR-X 051735	Q25LTR-X 051736	

maintained
With filament
lamp, 24 V

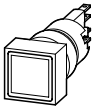

	–	Q18LTR-WS/WB 086708	Q25LTR-WS/WB 086447	10 off
	–	Q18LTR-GN/WB 086413	Q25LTR-GN/WB 086380	
	–	Q18LTR-RT/WB 086448	Q25LTR-RT/WB 086412	
	–	Q18LTR-GE/WB 086382	Q25LTR-GE/WB 086346	
	–	Q18LTR-BL/WB 086348	Q25LTR-BL/WB 086330	

Contact configuration:
⊕ = Safety function by positive opening according to IEC/EN 60947-5-1

N/O = normally open contact N/C = normally closed contact

Contact sequence Contact diagram Color Part no. Article no. Std. pack

Contact elements

Operational voltage: 5 - 250 V

1 N/O	–				E10 090351	50 off
–	1 N/C ⊕				E01 090401	50 off

Notes

 x = Sequence number on front element
 y = Function number on contact element



Front dimensions
18 × 18 mm

Front dimensions
25 × 25 mm

Function:	Color	Part no. Article no.	Part no. Article no.	Std. pack
▷ = momentary				
┘ = maintained				

Changeover switches, IP65

Incl. anti-rotation feature VS

Two positions

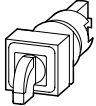

▷ 45°	○	Q18WK1 036515	Q25WK1 036599	5 off
┘ 45°	○	Q18WK1R 036598	Q25WK1R 036600	

Three positions

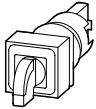

45° ◁ ▷ 45°	○	Q18WK3 072308	Q25WK3 072372	5 off
45° ▷ 45°	○	Q18WK3R 072309	Q25WK3R 072373	
45° ▷ ◁ 45°	○	Q18WK3R1 072310	Q25WK3R1 072374	
45° ◁ ▷ 45°	○	Q18WK3R2 072311	Q25WK3R2 072375	

Illuminated selector switch actuators, IP65

With VS anti-rotation tab

Without filament lamp

Two positions

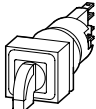

▷ 45°	○	Q18LWK1-WS 040349	Q25LWK1-WS 040658	5 off
▷ 45°	●	Q18LWK1-RT 039337	Q25LWK1-RT 040657	
▷ 45°	●	Q18LWK1-GN 039336	Q25LWK1-GN 040656	
┘ 45°	○	Q18LWK1R-WS 040376	Q25LWK1R-WS 040661	
┘ 45°	●	Q18LWK1R-RT 040351	Q25LWK1R-RT 040660	
┘ 45°	●	Q18LWK1R-GN 040350	Q25LWK1R-GN 040659	

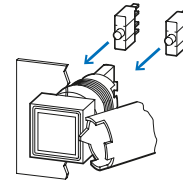

Accessories	Page
Assembly aids and accessories	→ 138
Contact elements	
N/O Contact	→ 126
N/C contact	→ 126

With filament lamp, 24 V

Two positions

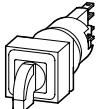

▷ 45°	○	Q18LWK1-WS/WB 038978	Q25LWK1-WS/WB 040379	5 off
▷ 45°	●	Q18LWK1-RT/WB 038930	Q25LWK1-RT/WB 040378	
▷ 45°	●	Q18LWK1-GN/WB 038883	Q25LWK1-GN/WB 040377	
┘ 45°	○	Q18LWK1R-WS/WB 039335	Q25LWK1R-WS/WB 040476	
┘ 45°	●	Q18LWK1R-RT/WB 039248	Q25LWK1R-RT/WB 040381	
┘ 45°	●	Q18LWK1R-GN/WB 039247	Q25LWK1R-GN/WB 040380	



Front dimensions
18 × 18 mm

Front dimensions
25 × 25 mm

Function:

Color

Part no.
Article no.

Part no.
Article no.

Std. pack

↘ = momentary
↙ = maintained

Illuminated selector switch actuators, IP65

With VS anti-rotation tab

Without filament lamp
Three positions

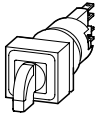

45° ↘↙ 45°	○	Q18LWK3-WS 072322	Q25LWK3-WS 072358	5 off
45° ↘↙ 45°	●	Q18LWK3-RT 072323	Q25LWK3-RT 072359	
45° ↘↙ 45°	●	Q18LWK3-GN 072324	Q25LWK3-GN 072360	
45° ↘↙ 45°	○	Q18LWK3R-WS 072325	Q25LWK3R-WS 072361	
45° ↘↙ 45°	●	Q18LWK3R-RT 072326	Q25LWK3R-RT 072362	
45° ↘↙ 45°	●	Q18LWK3R-GN 072327	Q25LWK3R-GN 072363	
45° ↘↙ 45°	○	Q18LWK3R1-WS 072328	Q25LWK3R1-WS 072364	
45° ↘↙ 45°	●	Q18LWK3R1-RT 072329	Q25LWK3R1-RT 072365	
45° ↘↙ 45°	●	Q18LWK3R1-GN 072330	Q25LWK3R1-GN 072366	
45° ↘↙ 45°	○	Q18LWK3R2-WS 072331	Q25LWK3R2-WS 072367	
45° ↘↙ 45°	●	Q18LWK3R2-RT 072332	Q25LWK3R2-RT 072368	
45° ↘↙ 45°	●	Q18LWK3R2-GN 072333	Q25LWK3R2-GN 072369	

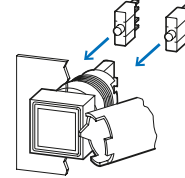

Accessories	Page
Assembly aids and accessories	→ 138
Contact elements	
N/O Contact	→ 126
N/C contact	→ 126

With filament lamp, 24 V
Three positions

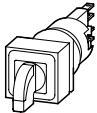

45° ↘↙ 45°	○	Q18LWK3-WS/WB 072334	Q25LWK3-WS/WB 072346	5 off
45° ↘↙ 45°	●	Q18LWK3-RT/WB 072335	Q25LWK3-RT/WB 072347	
45° ↘↙ 45°	●	Q18LWK3-GN/WB 072336	Q25LWK3-GN/WB 072348	
45° ↘↙ 45°	○	Q18LWK3R-WS/WB 072337	Q25LWK3R-WS/WB 072349	
45° ↘↙ 45°	●	Q18LWK3R-RT/WB 072338	Q25LWK3R-RT/WB 072350	
45° ↘↙ 45°	●	Q18LWK3R-GN/WB 072339	Q25LWK3R-GN/WB 072351	
45° ↘↙ 45°	○	Q18LWK3R1-WS/WB 072340	Q25LWK3R1-WS/WB 072352	
45° ↘↙ 45°	●	Q18LWK3R1-RT/WB 072341	Q25LWK3R1-RT/WB 072353	
45° ↘↙ 45°	●	Q18LWK3R1-GN/WB 072342	Q25LWK3R1-GN/WB 072354	
45° ↘↙ 45°	○	Q18LWK3R2-WS/WB 072343	Q25LWK3R2-WS/WB 072355	
45° ↘↙ 45°	●	Q18LWK3R2-RT/WB 072344	Q25LWK3R2-RT/WB 072356	
45° ↘↙ 45°	●	Q18LWK3R2-GN/WB 072345	Q25LWK3R2-GN/WB 072357	

Function:	Key withdrawable in position	Color	Part no. Article no.	Part no. Article no.	Std. pack
-----------	------------------------------	-------	----------------------	----------------------	-----------

↘ = momentary
 ↙ = maintained

Front dimensions 18 × 18 mm Front dimensions 25 × 25 mm

IP65, key-operated actuators

With 1 key and VS anti-rotation tab

Two positions

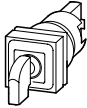

↘ 45°	-	0	-	●	Q18S1 038806	Q25S1 038773	5 off
↙ 45°		0	-	●	Q18S1R 038805	Q25S1R 038772	
↘ 45°	-	0	-	●	Q18S1R-A1 072312	Q25S1R-A1 072376	
↘ 45°	-	0	-	●	Q18S1-GN 062148	Q25S1-GN 062150	
↙ 45°		0	-	●	Q18S1R-GN 062151	Q25S1R-GN 062108	
↘ 45°	-	0	-	●	Q18S1-RT 046841	Q25S1-RT 046843	
↙ 45°		0	-	●	Q18S1R-RT 046837	Q25S1R-RT 046839	
↘ 45°	-	0	-	○	Q18S1-WS 046849	Q25S1-WS 046851	
↙ 45°		0	-	○	Q18S1R-WS 046845	Q25S1R-WS 046847	
↘ 45°	-	0	-	●	Q18S1-BL 045959	Q25S1-BL 046835	
↙ 45°		0	-	●	Q18S1R-BL 062814	Q25S1R-BL 045502	

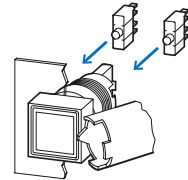

Accessories

Assembly aids and accessories

Contact elements

N/O Contact

N/C contact

Page

→ 138

→ 126

→ 126

Three positions

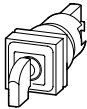

45° ↘ 45°	-	0	-	●	Q18S3 072313	Q25S3 072377	5 off
45° ↘ 45°		0		●	Q18S3R 072314	Q25S3R 072378	
45° ↘ 45°	-	0	-	●	Q18S3R-A1 072315	Q25S3R-A1 072379	
45° ↘ 45°		0	-	●	Q18S3R-A2 072316	Q25S3R-A2 072380	
45° ↘ 45°	-	0		●	Q18S3R-A3 072317	Q25S3R-A3 072381	
45° ↘ 45°		0	-	●	Q18S3R-A4 072318	Q25S3R-A4 072382	
45° ↘ 45°	-	0	-	●	Q18S3R-A5 072319	Q25S3R-A5 072383	
45° ↘ 45°	-	0		●	Q18S3R-A6 072320	Q25S3R-A6 072384	
45° ↘ 45°	-	0	-	●	Q18S3R-A7 072321	Q25S3R-A7 072385	
45° ↘ 45°	-	0	-	●	Q18S3-GN 062149	Q25S3-GN 062153	
45° ↘ 45°		0		●	Q18S3R-GN 062152	Q25S3R-GN 062147	
45° ↘ 45°	-	0	-	●	Q18S3-RT 046842	Q25S3-RT 046844	
45° ↘ 45°		0		●	Q18S3R-RT 046838	Q25S3R-RT 046840	
45° ↘ 45°	-	0	-	○	Q18S3-WS 046850	Q25S3-WS 046852	
45° ↘ 45°		0		○	Q18S3R-WS 046846	Q25S3R-WS 046848	
45° ↘ 45°	-	0	-	●	Q18S3-BL 046368	Q25S3-BL 046836	
45° ↘ 45°		0		●	Q18S3R-BL 064430	Q25S3R-BL 045646	

Notes

For each color there is a corresponding key.
 → Page 139



Front dimensions
18 × 18 mm

Front dimensions
25 × 25 mm

Color

Part no.
Article no.

Part no.
Article no.

Std. pack

Indicator lights, IP65

flush
Without filament
lamp

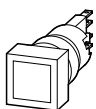

	Q18LF-WS 088406	Q25LF-WS 090228	10 off
	Q18LF-GN 088337	Q25LF-GN 090000	
	Q18LF-RT 088387	Q25LF-RT 090198	
	Q18LF-GE 088303	Q25LF-GE 089252	
	Q18LF-BL 088270	Q25LF-BL 089229	

flush
Without lens

—	Q18LX 051739	Q25LX 051740	10 off
---	------------------------	------------------------	--------

flush
With filament
lamp, 24 V

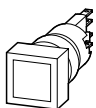

	Q18LF-WS/WB 088059	Q25LF-WS/WB 089151	10 off
	Q18LF-GN/WB 087947	Q25LF-GN/WB 088828	
	Q18LF-RT/WB 088001	Q25LF-RT/WB 089104	
	Q18LF-GE/WB 087915	Q25LF-GE/WB 088798	
	Q18LF-BL/WB 087860	Q25LF-BL/WB 088761	

Conical
Without filament
lamp

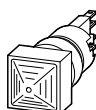

	Q18LH-WS 088705	Q25LH-WS 086263	10 off
	Q18LH-GN 088629	Q25LH-GN 086207	
	Q18LH-RT 088655	Q25LH-RT 086241	
	Q18LH-GE 088585	Q25LH-GE 090481	
	Q18LH-BL 088560	Q25LH-BL 090428	

Conical
With filament
lamp, 24 V

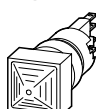

	Q18LH-WS/WB 088535	Q25LH-WS/WB 090405	10 off
	Q18LH-GN/WB 088483	Q25LH-GN/WB 090312	
	Q18LH-RT/WB 088507	Q25LH-RT/WB 090354	
	Q18LH-GE/WB 088448	Q25LH-GE/WB 090285	
	Q18LH-BL/WB 088424	Q25LH-BL/WB 090240	



Front dimensions
25 × 25 mm

Color Degree of protection Part no. Article no. Std. pack

Emergency-stop pushbuttons

Tamper-proof according to ISO 13850, EN 418
Pushbutton remains in pushed position; released by pulling
Can also be used as emergency-stop key-release mushroom

Non-illuminated

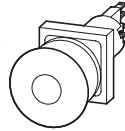

IP65

Q25PV
072370

5 off

Illuminated

with built-in multiple LED, 24 V DC, $I_g = 15$ mA
Positive pole at X1
No bulb replacement required.



IP65

Q25LPV
072371

2 off

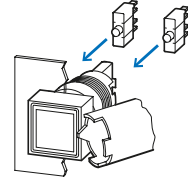

Accessories

Assembly aids and accessories

Contact elements

N/O Contact

N/C contact

Page

→ 138

→ 126

→ 126

Emergency-stop pushbuttons

Overload-protected to ISO 13850, EN 418
Pushbutton remains in pushed position; released by pulling

Non-illuminated

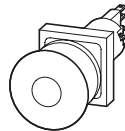

IP65

Q25PV-S
257063

5 off

Illuminated

with built-in multiple LED, 24 V DC, $I_g = 15$ mA
Positive pole at X1
No bulb replacement required.



IP65

Q25LPV-S
257064

5 off

Emergency-stop labels

Yellow, black lettering

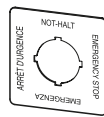

Square
50 × 50 mm
de, en, fr, it

IP65

SQT11
121375

5 off



Round
ø 60 mm
de, en, fr, it

IP65

SRT11
121374

5 off

Emergency-stop labels

Yellow, black lettering



Square
50 × 50 mm
de, en, fr, it

IP65

SQT1
058874

5 off



Round
ø 60 mm
de, en, fr, it

IP65

SRT1
058873

5 off

Emergency-stop labels

Blank, yellow

Not suitable for engraving

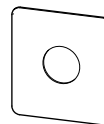

Square
50 × 50 mm

IP65

SQ-GE
063263

5 off

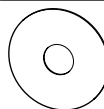































Round
ø 60 mm

IP65

SR-GE
063264

5 off

















Button plates for pushbutton actuators

Inscription	Symbol	18 x 18 mm		25 x 25 mm		Std. pack
		Part no. Article no.	Part no. Article no.	Part no. Article no.	Part no. Article no.	
Marking plates						
-		01TQ18 086816	01TQ25 091121			20 off
-		02TQ18 086859	02TQ25 091149			
-		03TQ18 087766	03TQ25 091184			
-		04TQ18 087834	04TQ25 091442			
-		05TQ18 087867	05TQ25 091471			
-		06TQ18 087920	06TQ25 091506			
With customized inscription via Labeleditor → Notes		XQ18D-*. *1) 285286	XQ25D-*. *1) 285287			1 off
OFF		10TQ18 087951	10TQ25 091536			20 off
STOP or OFF		19TQ18 054510	19TQ25 054508			
ON		11TQ18 088007	11TQ25 091562			
START or ON		20TQ18 054509	20TQ25 054507			
START or ON		21TQ18 088061	21TQ25 091586			
Direction of movement		32TQ18 088125	32TQ25 091618			
Direction of movement		36TQ18 088275	36TQ25 092592			
Electr. voltage		34TQ18 095386	34TQ25 092563			
Increase		37TQ18 088315	37TQ25 092608			
Decrease		38TQ18 088340	38TQ25 092645			
Manual operation		40TQ18 088389	40TQ25 092709			
Automatic		41TQ18 088412	41TQ25 092774			
ON-OFF, momentary		43TQ18 088426	43TQ25 092791			
Unlock		52TQ18 088452	52TQ25 092825			
Lock		53TQ18 088487	53TQ25 092874			
Unclamp		54TQ18 088512	54TQ25 093013			
Clamp		55TQ18 088545	55TQ25 093032			
Liquid START			921TQ25 047426			
Liquid STOP		63TQ18 088566	63TQ25 093060			
Klaxon		66TQ18 088590	66TQ25 093092			
Spindle START			811TQ25 053898			
Spindle STOP			814TQ25 047425			
ON-OFF, maintained		899TQ18 089232	899TQ25 093063			

Notes

- When ordering, complete part no. XQ18D-*. * or XQ25D-*. *:
 - Wildcard * Δ color, e.g.: -R (red), -G (green), -B (blue), -W (white), -Y (yellow), -S (black)
 - Wildcard * Δ file name generated by Labeleditor → Engineering, Page 74
- Lenses for illuminated pushbutton actuators, indicator lights, laser inscription → Page 139



















Button plates for pushbutton actuators

























Inscription	Symbol	18 x 18 mm		25 x 25 mm		Std. pack
		Part no. Article no.	Part no. Article no.	Part no. Article no.	Part no. Article no.	
Marking plates						
Direction of movement		911TQ18 089778	911TQ25 093100			20 off
Direction of movement		912TQ18 090181	912TQ25 093135			
	0	80TQ18 088631	80TQ25 093134			
	1	81TQ18 088663	81TQ25 093158			
	2	82TQ18 088715	82TQ25 093178			
	3	83TQ18 088744	83TQ25 093197			
	4	84TQ18 088766	84TQ25 093224			
	5	85TQ18 088811	85TQ25 093241			
	6	86TQ18 089069	86TQ25 093257			
	7	87TQ18 089107	87TQ25 093288			
	8	88TQ18 089165	88TQ25 093305			
	9	89TQ18 089205	89TQ25 093329			
STOP			110TQ25 093363			
STOP			112TQ25 063748			
ARRET			310TQ25 091446			
START			111TQ25 093399			
START			122TQ25 063746			
MARCHE			311TQ25 091475			
AUS			117TQ25 093434			
AUS			113TQ25 063749			
OFF			217TQ25 090911			
ARRET			317TQ25 091508			
EIN			121TQ25 093461			
EIN			123TQ25 063747			
ON			221TQ25 090934			
MARCHE			321TQ25 091563			

Notes

Lenses for illuminated pushbutton actuators, indicator lights, laser inscription → Page 139











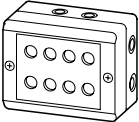

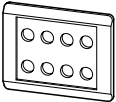

Button plates for pushbutton actuators
25 x 25 mm

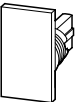
Inscription	Symbol	Part no. Article no.	Std. pack
Marking plates			
LINKS		134T025 093494	20 off
LEFT		234T025 090987	
GAUCHE		334T025 092567	
RECHTS		135T025 093527	
RIGHT		235T025 091009	
DROITE		335T025 092594	
ZU		153T025 090632	
CLOSE		253T025 091089	
FERME		353T025 092609	
AUF		172T025 090732	
UP		272T025 091124	
MONTEE		372T025 092711	
AB		173T025 090822	
DOWN		273T025 091152	
DESCENTE		373T025 092775	
RESET		287T025 091185	
VOR		190T025 090852	
ZURÜCK		191T025 090866	
Notes	Lenses for illuminated pushbutton actuators, indicator lights, laser inscription → Page 139		

Inscription		Label mounts Q25T... with insert label Part no. Article no.	Insert plates for Q25T...-X label mount Part no. Article no.	Std. pack
Marking plates				
Blank, black, suitable for engraving		Q25TS-01 046184	01S025 037986	20 off
Blank, aluminium-colored, suitable for engraving		Q25TS-02 046185	02S025 038074	
Blank, yellow, not suitable for engraving		Q25TGE-05 063259	05S025 063201	
AUS		Q25TS-117 046194		
EIN		Q25TS-121 046196		
ON		Q25TS-221 046197		
STOP		Q25TS-110 046190	110S025 038507	
START		Q25TS-111 046192		
Störung		Q25TS-150 046198		
FAULT		Q25TS-250 046199		
DÉFAUT		Q25TS-386 072306	386S025 072302	
Betrieb		Q25TS-183 046201		
EN SERVICE		Q25TS-383 046204		
HAND 0 AUTO		Q25TS-197 072305		
MAN. 0 AUTO		Q25TS-397 072307		
NOT-AUS		Q25TGE-199 063260	199S025 063200	
EMERGENCY STOP		Q25TGE-299 063261	299S025 063199	
RUN			283S025 038767	
EN SERVICE			383S025 038771	
ARRET D'URGENCE			399S025 048638	
-		Q25TS-10 046186	10S025 038268	
-		Q25TS-11 046187		
-		Q25TS-32 046188		
-		Q25TS-90 046189	90S025 038271	
-		Q25TS-93 072304	93S025 072300	
With customized inscription via Labeleditor → Notes	-	XQ25TS-*.* 109773		1 off

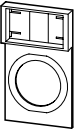
Notes



















- When ordering, complete part no. XQ25TS-*.*:
 1. Wildcard * Δ color: AL = aluminum, B = black, Y = yellow
 2. Wildcard * Δ file extension

	Color	RAL number	Part no. Article no.	Std. pack
Surface mounting enclosure, IP65¹⁾				
For conventional wiring with moulded cover fixing screws Enclosure base: black (RAL 9005) 8 mounting locations Knockout cable entry Bottom: 4 x M20 Sides: 7 x M20				
		RAL 7035	I8 046299	2 off
Flush mounting plate, IP65¹⁾				
For conventional wiring 8 mounting locations				
		RAL 7035	E8 054423	1 off
		RAL 9005	E8-SW 065212	1 off
Customized complete unit				
Parameterizable To order use form FO315 → Data sheet in Online Catalog				
	-		M16-COMBINATION 2010762	1 off
Blanking plates, IP65				
For closing off of spare mounting locations in surface mounting enclosures or flush mounting plates in grid dimension 25 × 37.5 mm				
		RAL 9005	Q25AS 036602	10 off
		RAL 7035	Q25AGR 048641	
		RAL 1004	Q25AGE 048640	
Label mounts without insert label				
For additional marking of mounting locations in surface mounting enclosures or flush mounting plates in grid dimension 25 × 37.5 mm Suitable insert labels → Page 136				
		RAL 9005	Q25TS-X 036601	20 off
		RAL 7035	Q25TGR-X 063257	
		RAL 1004	Q25TGE-X 063258	

Notes

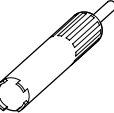
¹⁾ Unused mounting locations must be closed off with blanking plates.
Each used mounting location must be fitted with a label mount.

3

Type	Lifespan EN 60064, $t_a = +25\text{ °C}$ $t_{\text{avge}}(\text{AC})$ h	Color	Part no. Article no.	Std. pack
Filament lamp W 2 × 4.6 d				
 6 V/1.0 W	10000	–	WBGL6 090223	50 off
12 V/1.0 W	15000	–	WBGL12 089968	50 off
24 - 28 V/1.0 W	7000	–	WBGL24 089247	100 off
Multiple LEDs W 2 × 4.6 d				
 For AC/DC 6 V/45 mA	60000		WBLED-GE6 055711	10 off
			WBLED-GN6 055712	
			WBLED-RT6 055713	
12 V/24 mA	60000		WBLED-GE12 055714	
			WBLED-GN12 055715	
			WBLED-RT12 055716	
Single chip LED W 2 × 4.6 d				
Positive pole to X1, Integral suppressor circuit up to 1000 V				
 18 - 30 V DC/7 - 12.5 mA	100000		LEDWB-Y 208724	10 off
			LEDWB-G 208725	
			LEDWB-R 208726	
			LEDWB-W 208728	
			LEDWB-B 208727	
Mounting ring tool				
For fixing nut with bulb extractor				
	–	–	R16-MS 090297	10 off
Insulated ferrule				
For fast-on connector 2.8 × 0.8 mm, plug-in type from front $U_g > 50\text{ V AC}$, $U_g > 120\text{ V DC}$				
	–	–	ISH2.8 090267	100 off
Fast-on connector				
2.8 × 0.8 mm for conductor cross-section 0.5 - 1 mm ²				
	–	–	LT306.022.3 058863	100 off
Blanking plugs, IP65				
For closing off of spare mounting locations				
	For grid dimension 18 × 18 mm	–	Q18BS 037985	10 off
		For grid dimension 25 × 25 mm	–	Q25BS 036976
Anti-rotation tab				
Guard-ring as anti-rotation tab for all RMQ16 buttons				
	–	–	VS 046301	50 off

WWW.TM2A.PT info@tm2a.pt

WWW.TM2A.PT info@tm2a.pt



For use with	Color	Part no. Article no.	Std. pack
Screw adapter, IP20			
Conductor cross-sections 1 × 1.5 mm ² , 2 × 0.75 mm ²			
For N/C contacts		SRA01 028101	20 off
For N/O contacts		SRA10 028100	
For lamp socket		SRAL 028099	



Individual key			
Standard lock mechanism, black, each color corresponds to a specific lock mechanism			
–		ES16 065190	10 off
–		ES16-GN 030742	5 off
–		ES16-RT 030741	
–		ES16-WS 030743	
–		ES16-BL 030744	

Transparent insert plates

For better light diffusion			
For grid dimension 18 × 18 mm		01LQ18 090231	20 off
For grid dimension 25 × 25 mm		01LQ25 093180	

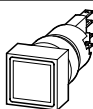

Lenses for illuminated pushbutton

With customized inscription to order via Labeleditor → Notes			
For grid dimension 18 × 18 mm	–	XQ18LT-*.* 285288	1 off
For grid dimension 25 × 25 mm	–	XQ25LT-*.* 285289	

Lenses for indicator lights, flush

With customized inscription to order via Labeleditor → Notes			
For grid dimension 18 × 18 mm	–	XQ18LF-*.* 285310	1 off
For grid dimension 25 × 25 mm	–	XQ25LF-*.* 285311	

Insert labels for label mounts

For laser inscription with Labeleditor → Notes			
For Q25TS-...	–	XQ25TS-*.* 109773	1 off

Notes

- When ordering, complete part no. XQ...-*.*:
 1. Wildcard * ≙ color, e. g.: -R (red), -G (green), -B (blue), -W (white), -Y (yellow), -S (black)
 2. Wildcard * ≙ file name generated by Labeleditor → Engineering, Page 74

Technical data

3

			Contact elements	Illuminated push-button actuators (maintained)	Illuminated selector switch actuators	Indicator lights
General						
Standards			IEC/EN 60947, VDE 0660			
Lifespan, mechanical	Operations	x 10 ⁶	> 100	> 30	> 3	–
Operating frequency	Operations/h		≤ 3600	≤ 1800	≤ 1800	–
Operating force	N		3	4	–	–
Operating torque	Nm		–	–	≤ 0.2	–
Degree of protection, IEC/EN 60529			IP20 with ISH2.8	IP65	IP65	IP65
Climatic proofing			Damp heat, constant as per IEC 60068-2-78 Damp heat, cyclic, to IEC 60068-2-30			
Ambient air temperature						
Open	°C		-25 - +60	-25 - +60	-25 - +60	-25 - +60
Enclosed	°C		-25 - +40	-25 - +40	-25 - +40	-25 - +40
Mounting position			any	any	any	any
Mechanical shock resistance to IEC 60068-2-27 Shock duration 11 ms, half-sinusoidal			g	> 40	> 40	> 40
Terminal capacity			mm ²	0.5 - 1.0	0.5 - 1.0	0.5 - 1.0
Blade terminal			2.8 x 0.8 mm to DIN 46244			
Fast-on connector			2.8 x 0.8 mm to DIN 46247 and IEC 60760			
Contacts						
Rated impulse withstand voltage	U _{imp}	V AC	4000	800	800	800
Rated insulation voltage	U _i	V	250	250	250	250
Overvoltage category/degree of pollution			III/3	III/3	III/3	III/3
Rated operating voltage	U _e	V AC	250	24	24	24
Control circuit reliability						
At 24 V DC/5 mA	H _F	Fault probability	< 10 ⁻⁷ (i.e. 1 failure to 10 ⁷ operations)			–
At 5 V DC/1 mA	H _F	Fault probability	< 5 x 10 ⁻⁶ (i.e. 1 failure to 5 x 10 ⁶ operations)			–
Use of ISH insulated ferrule 2.8			On > 24 V AC/DC recommended On > 50 V AC or 120 V DC mandatory, also on unoccupied blade terminals			
Max. short-circuit protective device						
fuseless			Part no.	FAZ-B6/1	–	–
Fuse			gG/gL	A	10	–
Switching capacity						
Rated operational current						
AC-15						
24 V	I _e	A	4	–	–	–
48 V	I _e	A	4	–	–	–
110 V	I _e	A	4	–	–	–
230 V	I _e	A	4	–	–	–
DC-13						
24 V	I _e	A	3	–	–	–
42 V	I _e	A	1	–	–	–
60 V	I _e	A	0.8	–	–	–
110 V	I _e	A	0.5	–	–	–
220 V	I _e	A	0.2	–	–	–

		Pushbuttons (maintained)	Changeover switches	Key-operated actuator	Emergency-stop pushbuttons
General					
Standards		IEC/EN 60947, VDE 0660	IEC/EN 60947, VDE 0660	IEC/EN 60947, VDE 0660	IEC/EN 60947, VDE 0660
Lifespan, mechanical	Operations	$\times 10^6$ > 3	> 3	> 3	> 0.1
Operating frequency	Operations/h	≤ 1800	≤ 1800	≤ 1800	≤ 600
Operating force	N	4	–	–	25
Operating torque	Nm	–	0.2	0.4	–
Degree of protection, IEC/EN 60529		IP65	IP65	IP65	IP65
Climatic proofing		Damp heat, constant as per IEC 60068-2-78 Damp heat, cyclic, to IEC 60068-2-30			
Ambient air temperature					
Open	°C	-25 - +60	-25 - +60	-25 - +60	-25 - +60
Enclosed	°C	-25 - +40	-25 - +40	-25 - +40	-25 - +40
Mounting position		any	any	any	any
Mechanical shock resistance to IEC 60068-2-27 Shock duration 11 ms, half-sinusoidal		g	> 40	> 40	> 40
Terminal capacity		mm ²	0.5 - 1.0	0.5 - 1.0	0.5 - 1.0
Blade terminal		2.8 × 0.8 mm to DIN 46244			
Fast-on connector		2.8 × 0.8 mm to DIN 46247 and IEC 60760			

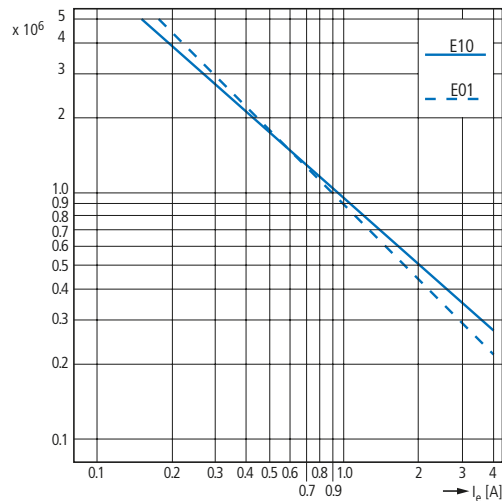

Lifespan, electrical AC-15 according to IEC/EN 60947-5-1 at 230 V; I_e = rated operational current

Dimensions

Actuating and indicator elements

Square style

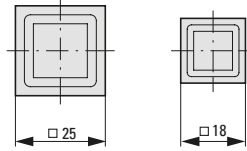
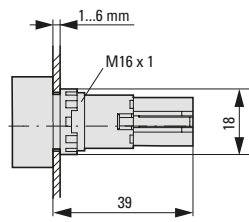

Q...BS

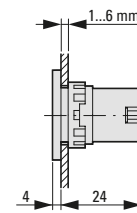

Q...D-...

Q...DR-...

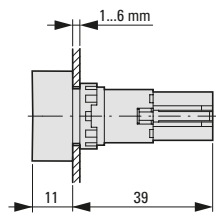

Q...S...

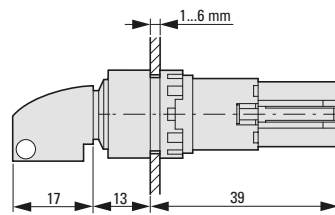

Q...WK...

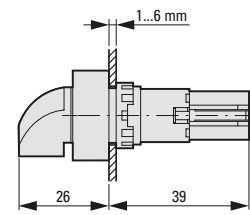

Q...LT-...

Q...LTR-...

Q...LF-...

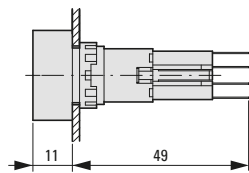

Q...LH-...

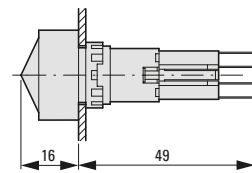

Q...LWK...

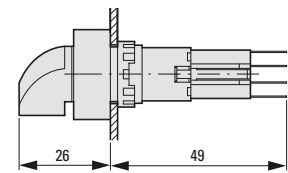

Q25PV...

Q25LPV...

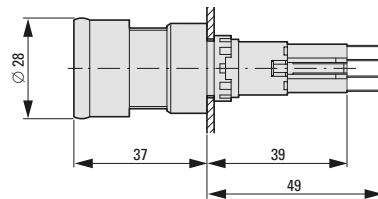
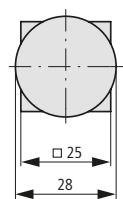

Front mount

Q18, Q25, E89, SRA, VS, M16

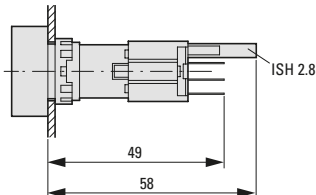
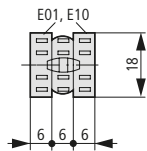

Drilling dimensions

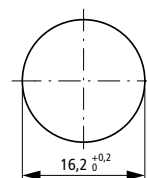

Grid dimension to IEC/EN 60947

Q25

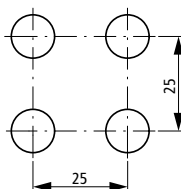

Minimum grid dimension

Q18

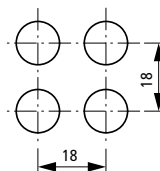

Mounting distance

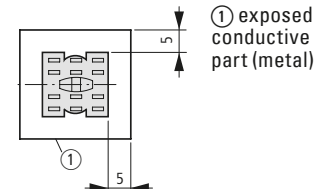

Flush mounting plate

E8...

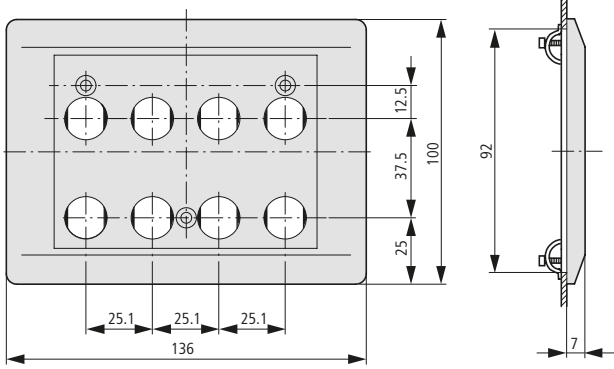

Size of cutout: 92 mm × 94 mm

RMQ16 screw adapters

SRA...

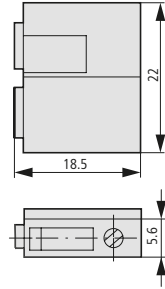

Anti-rotation tab

VS

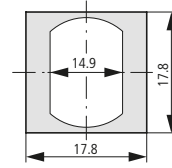

Housing extension RMQ16

I8...

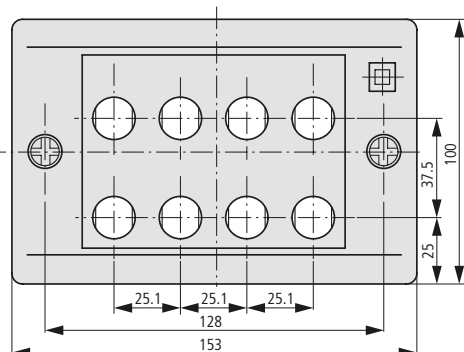
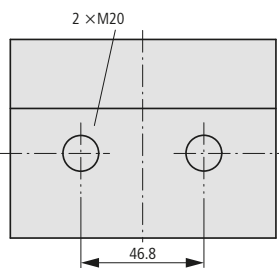
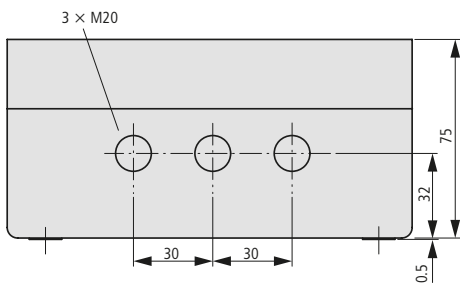
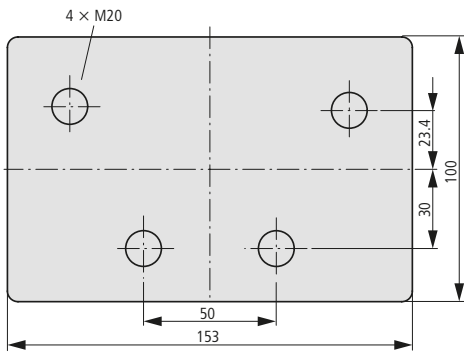

Fixing hole: 2 x Ø 4.5 mm

Distance: 128 mm

Label mounts RMQ16

Q25TS-...

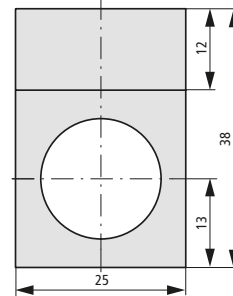

Blanking plates

Q25AS

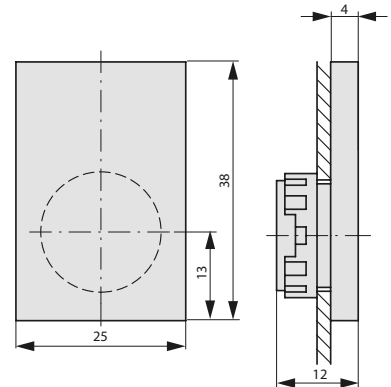

Build it in.



Foot and Palm Switches for Universal Use in all Kinds of environments

The large actuation surface on our heavy-duty FAK foot and palm switches makes them both intuitive and quick to use. In addition, they feature a tamper-proof design, preventing tampering during use. FAK devices can be actuated by hand, fist, elbow, or foot, ensuring that quick action can be taken to protect personnel and property whenever necessary. Finally, a high degree of shock resistance and extremely high IP67, IP69K degrees of protection make FAK units the ideal device for rugged applications.

FAK foot and palm switches with a red actuation surface on a yellow background are approved for use as emergency stop buttons. They perfectly match the characteristics required in DIN EN 60204, Safety of machinery – Electrical equipment of machines, and meet all relevant requirements. Moreover, the devices are tamper-proof (see IEC 60947-5) and feature positive-opening contacts (see IEC 60947-5-1).

www.eaton.eu/rmq

FAK



4.0 FAK foot and palm switch

4.0 System overview 145

4.1 Product selection
Complete units, individual components 146

4.2 Technical data, dimensions 147

System overview

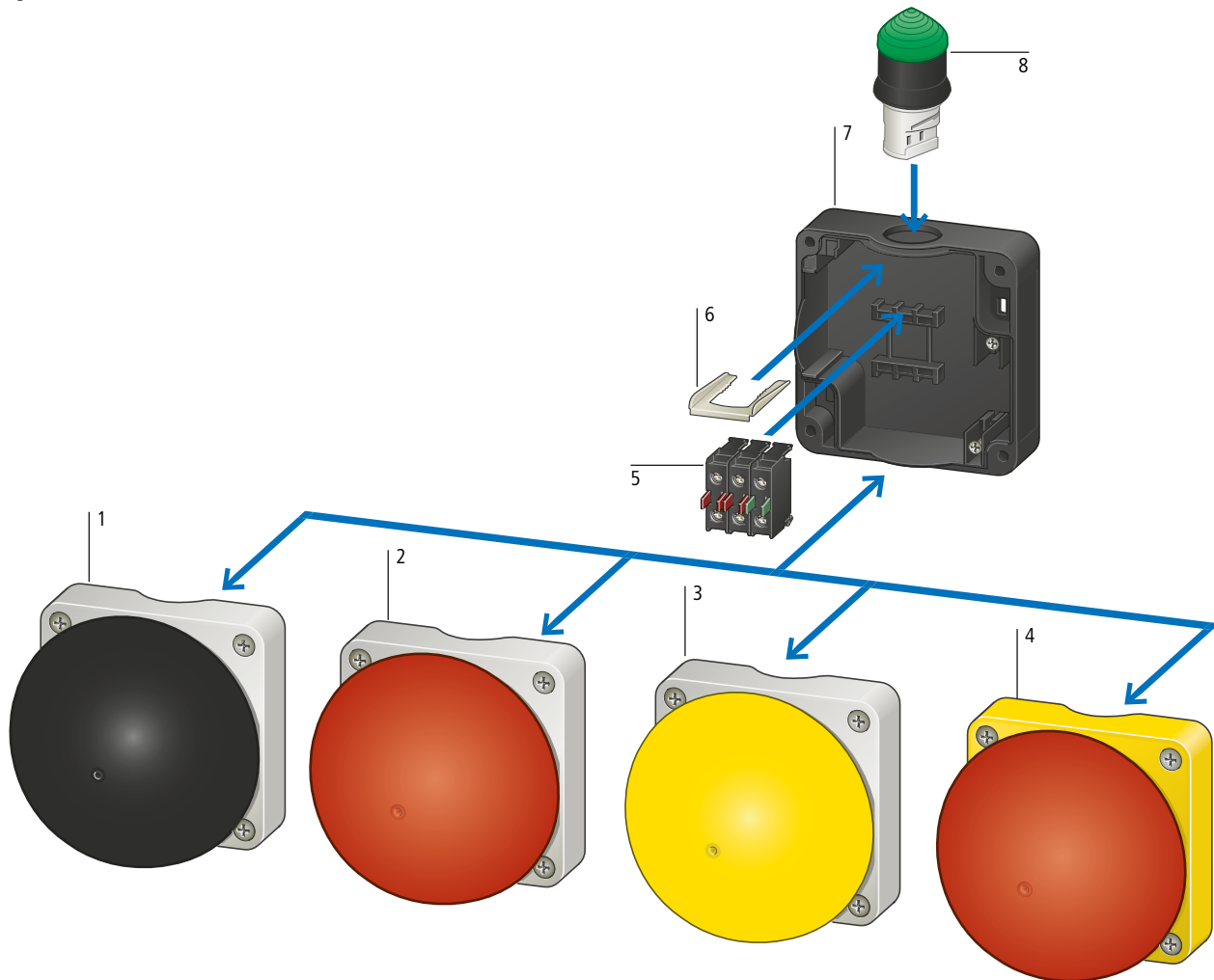

WWW.TM2A.PT info@tm2a.pt

WWW.TM2A.PT info@tm2a.pt

Enclosure base	7
Prepared for contact elements	
Base fixing (not for ...SMC... contacts)	
→ Page 146	
Operator only with button	1, 2,
Various color combinations	3, 4
Yellow/red for Emergency stop or emergency switching off applications	
European Machinery Safety Directive 2006/42/EC	
For foot or hand operation	
→ Page 146	

Contact elements	5
Base fixing	
→ Page 48	
Indicator lights	6, 8
Conical	
BA9s base	
→ Page 33	

Product selection

Contact configuration:
 ⊕ = Safety function by positive opening according to IEC/EN 60947-5-1

N/O = normally open contact
 N/C = normally closed contact

Contact sequence

Approval mark

Part no.
Article no.

Std. pack

4

Foot and palm switches FAK, IP67, IP69K

momentary

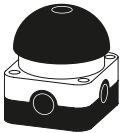

1 N/O

1 N/C ⊕



FAK-S/KC11/I
229749

1 off

momentary

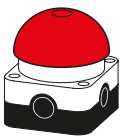

1 N/O

1 N/C ⊕



FAK-R/KC11/I
229746

1 off

maintained

Pull to release
Emergency-stop button tamper-proof to ISO 13850/EN 418

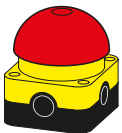

–

1 N/C ⊕



FAK-R/V/KC01/IY
229747

1 off

1 N/O

1 N/C ⊕



FAK-R/V/KC11/IY
229748

–

2 N/C ⊕



FAK-R/V/KC02/IY
256790



Customized complete units

An order consists of: enclosure base, enclosure top, contact elements for base fixing (→ Page 48)

FAK-COMBINATION 1 off
2010763



Enclosure base

For max. 3 contact elements

FAK-IU 1 off
229753

Enclosure top

momentary

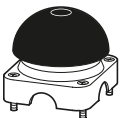

FAK-S 1 off
095540

momentary

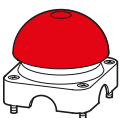

FAK-R
071810

momentary

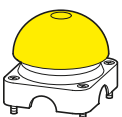

FAK-Y
229754

maintained

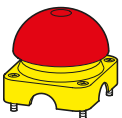

FAK-R/V/Y
229755

Technical data

		FAK foot and palm switch	
		momentary	maintained
General			
Standards		IEC/EN 60947, VDE 0660	IEC/EN 60947, VDE 0660
Lifespan, mechanical	Operations x 10 ⁶	1	0.1
Operating frequency	Operations/h	≤ 3600	≤ 600
Operating force	N	20 - 40	40 - 60
Degree of protection, IEC/EN 60529		IP67, IP69K	IP67, IP69K
Climatic proofing		Damp heat, constant, to IEC 60068-2-78 Damp heat, cyclic, to IEC 60068-2-30	
Ambient air temperature			
Open	°C	-25 - +40	-25 - +40
Mounting position		any	any
Mechanical shock resistance to IEC 60068-2-27		g	> 15
Shock duration 11 ms, half-sinusoidal			

4

Dimensions

FAK...

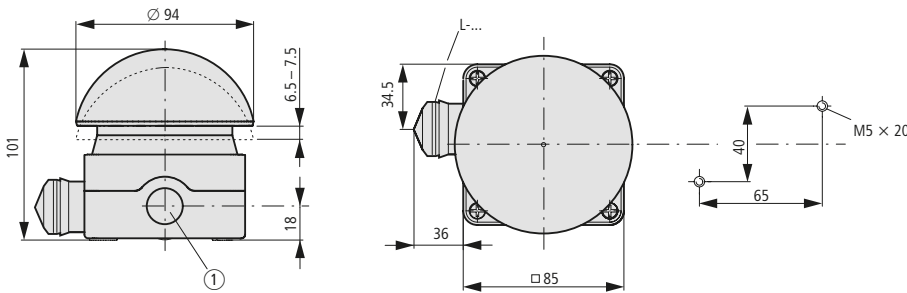

- ① 3 x M20 (Pg 13.5) lateral
- 1 x M16 in the base

Build it in.



Signal Operating States Quickly, Clearly, and Flexibly



SL7/SL4 signal towers configurator
www.eaton.eu/config/SL

SL4 and SL7 signal towers are used to continuously signal operating states for machines, systems, and processes. Their scope of application is extremely wide-ranging, going from production, through logistics, all the way to retail. This is in no small part thanks to the fact that the fast and clear signaling they provide ensures smooth and safe operation in any environment.

The light and acoustic modules in the series can be configured flexibly both in terms of volume and of the specific visual signals they emit. This versatility is only further enhanced by the signal towers' high-performance LEDs, which ensure that visual signals are recognized even under adverse light conditions. Moreover, a high IP66 degree of protection makes it possible to use the signal towers in demanding environments, such as outdoors.

With a diameter of 40 mm / 70 mm, SL4 and SL7 signal towers feature extremely compact dimensions designed to save space. In addition, only a few steps are required in order to quickly and easily install and remove them, which can prove to be a tremendous advantage when packing and transporting control panels or machines.

Connecting the signal towers to a SmartWire-DT communication system cuts down on wiring time and reduces the number of digital outputs required from your PLC. This, combined with the fact that data from the switchgear connected with SmartWire-DT will be processed in your PLC, ensures that operating states such as impending overloads will be detected and signaled with the signal towers immediately. The result? A marked increase in your systems' availability.

SL4/SL7



5.0	Signal towers	
5.1	System overview	
	SL4 – System	150
5.2	Product selection	
	SL4 – Complete devices, light modules	152
	SL4 – Light modules	153
	SL4 – Light modules, acoustic modules	155
	SL4 – Base modules	156
	SL4 – Base modules, accessories	157
5.3	System overview	
	SL7 – System	158
5.4	Product selection	
	SL7 – Complete devices, light modules	160
	SL7 – Light modules	161
	SL7 – Acoustic modules	164
	SL7 – Base modules	165
	SL7 – Base modules, accessories	166
5.5	Technical data	
	SL4 – Technical data	167
	SL7 – Technical data	169
5.6	Dimensions	
	SL4 – Dimensions	171
	SL7 – Dimensions	175

5.1

Signal towers

SL4 – System overview

Moeller series

System overview

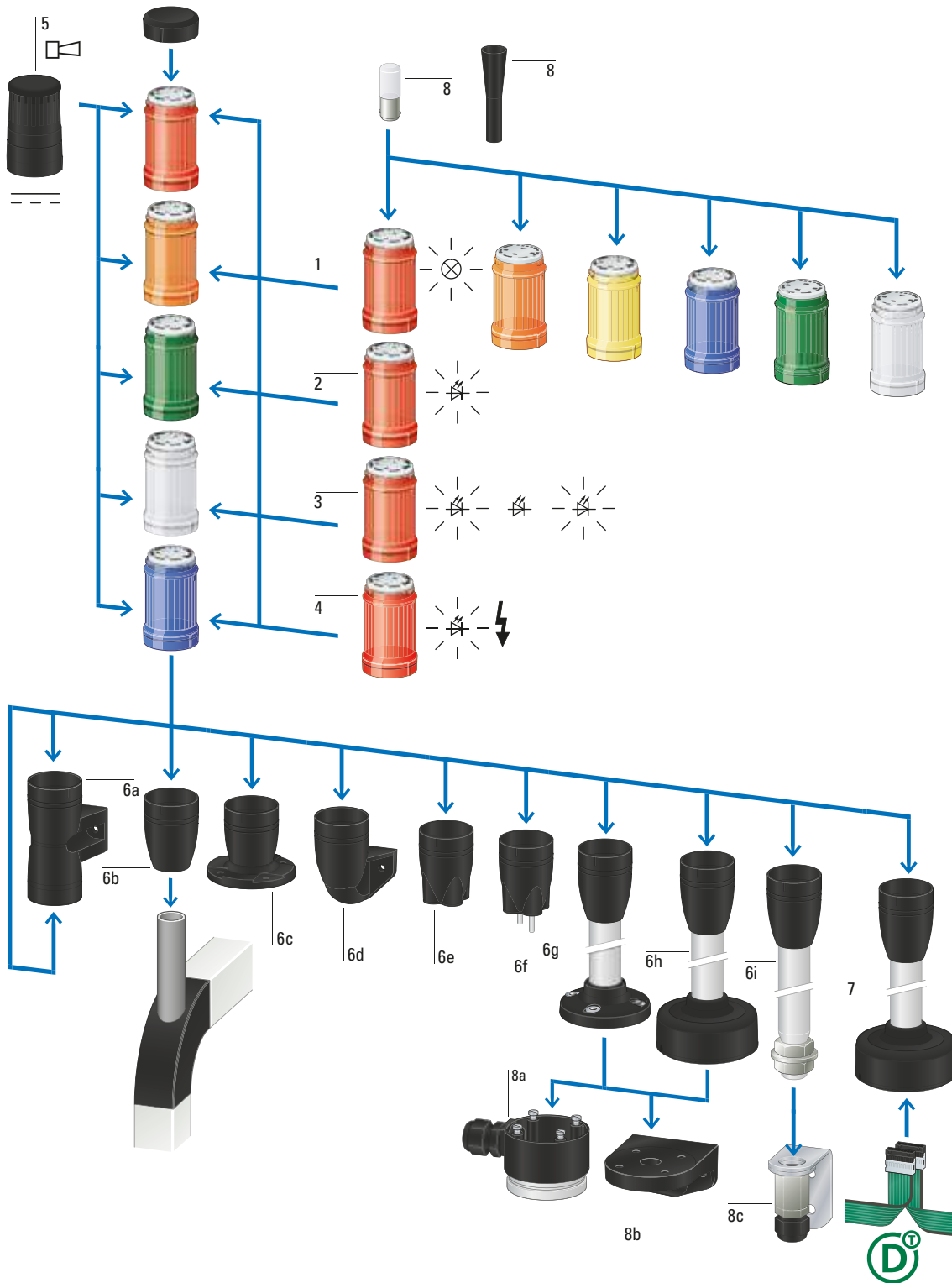

5

WWW.TM2A.PT info@tm2a.pt

WWW.TM2A.PT info@tm2a.pt

Module for filament lamp, continuous light 1

Without light element (filament lamp with BA15d socket)

Easy mounting with bayonet mount

Modules can be arranged in any order

Max. 2 x 5 modules that can be actuated individually (two with base module SL7-CB-D only)

Degree of protection IP66

Operating mode: 100% DF (duty factor)

→ Page 155

Module with LED, continuous light 2

Easy mounting with bayonet mount

Modules can be arranged in any order

Max. 2 x 5 modules that can be actuated individually (two with base module SL7-CB-D only)

Degree of protection IP66

Operating mode: 100% DF (duty factor)

→ Page 152

Module with LED, flashing light 3

Easy mounting with bayonet mount

Modules can be arranged in any order

Max. 2 x 5 modules that can be actuated individually (two with base module SL7-CB-D only)

Degree of protection IP66

Operating mode: 100% DF (duty factor)

Flashing frequency 2 Hz

→ Page 153

Module with LED, strobe light 4

With a fixed flashing frequency 1.4 Hz

With LED for effective signaling effect with various flashing sequences (flashing frequency 1 - 2.6 Hz)

Easy mounting with bayonet mount

Modules can be arranged in any order

Max. 2 x 5 modules that can be actuated individually (two with base module SL7-CB-D only)

Degree of protection IP66

Operating mode: 100% DF (duty factor)

→ Page 154

Acoustic module 5

Continuous tone or pulsed tone - adjustable with internal dip switches

Sound pressure 80 dB, frequency 4000 Hz

Easy mounting with bayonet mount

Set up as topmost module

Max. 2 x 1 module that can be actuated individually (two with base module SL7-CB-D only)

Degree of protection IP66

Permanently integrated cover plate

Operating mode: 100% DF (duty factor)

→ Page 155

Base module for mounting on both sides 6a

Easy mounting with bayonet mount

Degree of protection IP66

With cover plate

With Push in terminals

→ Page 157

Base module can hold tubes 6b

→ Page 156

Base module with external fixing holes 6c

→ Page 156

Base module one-sided with bracket 6d

→ Page 157

Base module with internal (on the inside) fixing holes 6e

→ Page 156

Base module with built-in (pre-assembled) fixing screws 6f

→ Page 156

Base module with aluminium tube and plastic foot 6g

Aluminium tube 100 mm, 250 mm or 400 mm

→ Page 157

Base module with base adapter for slipping onto place (rapid mounting and wiring system) 6h

Aluminium tube 100 mm, 250 mm or 400 mm

→ Page 156

Base module with aluminium tube and screw fixing 6h

Aluminium tube 100 mm, 250 mm or 400 mm

→ Page 156

Base module with base adapter for slipping onto place (rapid mounting and wiring system) and SmartWire-DT connection 7

Aluminium tube 100 mm

→ Page 156

Magnetic base including M20 cable gland 8a

For vertical mounting

→ Page 157

Mounting bracket 8b

For vertical mounting

→ Page 157

Accessories 8c











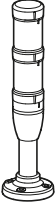









Tool for replacing filament lamp









Filament lamp

→ Page 157

Product selection

5

	Rated operational voltage U_e V	Number of modules	Color	Function	Part no. Article no.	Std. pack		
Complete units								
 <p>Continuous light LED IP66 Base module with foot and 100 mm spacer</p>	24 V AC/DC	2			SL4-100-L-RG-24LED 171295	1 off		
		3			SL4-100-L-RYG-24LED 171296			
Module with LED								
 <p>Continuous light IP66</p>	24 V AC/DC				SL4-L24-B 171313	1 off		
					SL4-L24-G 171314			
					SL4-L24-R 171315			
					SL4-L24-W 171316			
					SL4-L24-Y 171317			
					SL4-L24-A 171318			
			110/120 V AC				SL4-L120-B 171319	
					SL4-L120-G 171320			
					SL4-L120-R 171321			
					SL4-L120-W 171322			
					SL4-L120-Y 171323			
					SL4-L120-A 171324			
			230/240 V AC				SL4-L230-B 171325	
					SL4-L230-G 171326			
					SL4-L230-R 171327			
	SL4-L230-W 171328							
	SL4-L230-Y 171329							
	SL4-L230-A 171330							

	Rated operating voltage U_e V	Color	Function	Part no. Article no.	Std. pack
 <p>Module with LED Flashing light IP66 2 Hz</p>	24 V AC/DC			SL4-BL24-B 171337	1 off
				SL4-BL24-G 171338	
				SL4-BL24-R 171339	
				SL4-BL24-W 171340	
				SL4-BL24-Y 171341	
				SL4-BL24-A 171342	
	110/120 V AC		SL4-BL120-B 171343		
			SL4-BL120-G 171344		
			SL4-BL120-R 171345		
			SL4-BL120-W 171346		
			SL4-BL120-Y 171347		
			SL4-BL120-A 171348		
	230/240 V AC		SL4-BL230-B 171349		
			SL4-BL230-G 171350		
			SL4-BL230-R 171351		
			SL4-BL230-W 171352		
			SL4-BL230-Y 171353		
			SL4-BL230-A 171354		

Rated operating voltage
 U_e
V





























Color









Function







Part no.
Article no.

Std. pack

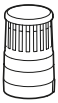
Module with LED

	Strobe light IP66 1.4 Hz	24 V AC/DC			SL4-FL24-B 171355	1 off
					SL4-FL24-G 171356	
					SL4-FL24-R 171357	
					SL4-FL24-W 171358	
					SL4-FL24-Y 171359	
					SL4-FL24-A 171360	
		110/120 V AC		SL4-FL120-B 171361		
				SL4-FL120-G 171362		
				SL4-FL120-R 171363		
				SL4-FL120-W 171364		
				SL4-FL120-Y 171365		
				SL4-FL120-A 171366		
		230/240 V AC		SL4-FL230-B 171367		
				SL4-FL230-G 171368		
				SL4-FL230-R 171369		
				SL4-FL230-W 171370		
				SL4-FL230-Y 171371		
				SL4-FL230-A 171372		
	Multistrobe light IP66 LED for effective signaling effect With various strobe sequences 1 - 2.6 Hz	24 V AC/DC			SL4-FL24-B-M 171373	1 off
					SL4-FL24-G-M 171374	
					SL4-FL24-R-M 171375	
					SL4-FL24-W-M 171376	
					SL4-FL24-Y-M 171377	
					SL4-FL24-A-M 171378	

	Rated operating voltage U_e V	Color	Function	Part no. Article no.	Std. pack
 <p>Module for filament lamp Continuous light IP66 Without lamp Filament lamp max. 4 W Filament lamp → Page 157</p>	< 250 V AC/DC			SL4-L-B 171331	1 off
				SL4-L-G 171332	
				SL4-L-R 171333	
				SL4-L-W 171334	
				SL4-L-Y 171335	
				SL4-L-A 171336	

	Rated operating voltage U_e V	Rated operational current I_e mA	Color	Function	Type of tone	Part no. Article no.	Std. pack
 <p>Acoustic modules Continuous tone or pulsed tone, adjustable with internal dip switches. Sound pressure 80 db, adjustable with internal potentiometer $f = 4000$ Hz Place only at the highest position on a pillar IP66</p>	24 V AC/DC	Max. 39				SL4-AP24 171379	1 off
	110/120 V AC	Max. 21				SL4-AP120 171380	
	230/240 V AC	Max. 21				SL4-AP230 171381	

	Rated operating voltage U_e V	Rated operational current I_e mA	Color	Function	Type of tone	Part no. Article no.	Std. pack
 <p>Customized complete unit Order please enquire</p>	-	-	-	-	-	SL4-COMBINATION 2011956	1 off

5.2

Signal towers





SL4 – Base modules





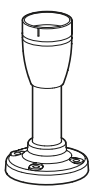
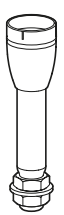

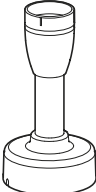
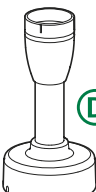

Moeller series

5

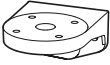
WWW.TM2A.PT info@tm2a.pt

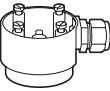
WWW.TM2A.PT info@tm2a.pt

	Tube length	Color	For use with	Part no. Article no.	Std. pack	
Base modules						
For horizontal mounting including cover max. 5 modules						
	Base with aluminium tube and plastic foot Push in terminals	100 mm	Black	SL4-L-... SL4-BL-... SL4-FL-... SL4-AP-...	SL4-PIB-100 171297	1 off
		250 mm	Aluminum color tube		SL4-PIB-250 171298	
		400 mm			SL4-PIB-400 171299	
		800 mm			SL4-PIB-800 177313	
	Base with aluminum tube and banjo bolt Push in terminals	100 mm			SL4-PIB-T-100 171305	
		250 mm			SL4-PIB-T-250 171306	
		400 mm			SL4-PIB-T-400 171307	
		800 mm			SL4-PIB-T-800 178461	
	Base with external fixing holes Push in terminals	–	Black		SL4-PIB-EMH 171302	
	Base with internal (on the inside) fixing holes Push in terminals	–			SL4-PIB-IMH 171300	
	Base with built-in (pre-assembled) fixing screws Push in terminals	–			SL4-PIB-IMS 171301	
	Base: Can hold tubes with a diameter of 25 mm (±0.5) for wall thickness 2 - 3.4 mm	–			SL4-PIB-TM 179986	
	Base with base adapter for slipping onto place (rapid mounting and wiring system) Screw terminals	100 mm	Black		SL4-FMS-100 171308	
		250 mm	Aluminum color tube		SL4-FMS-250 171309	
		400 mm			SL4-FMS-400 171310	
		800 mm			SL4-FMS-800 178463	
	Base with base adapter for slipping onto place (rapid mounting and wiring system) Blade terminal SWD4-8MF2 max. 0.3 A per module External power supply connectable (24 V DC) Parameterizable with SWD-Assist (planning and ordering help)	100 mm			SL4-SWD 171311	

	Color	For use with	Part no. Article no.	Std. pack																								
Base modules																												
	For vertical mounting including cover																											
	Black	SL4-L-... SL4-BL-... SL4-FL-... SL4-AP-...	SL4-PIB-FW 171303	1 off																								
	For vertical mounting on both sides including cover																											
	Black	SL4-L-... SL4-BL-... SL4-FL-... SL4-AP-...	SL4-PIB-D 171304	1 off																								
Mounting bracket																												
	For vertical mounting, insulated material																											
	–	SL4-PIB-... SL7-CB-...	SL7/4-FW 171446	1 off																								
Including mounting bracket M20 cable gland																												
	For vertical mounting, metal																											
	–	SL4-PIB-T-... SL7-CB-T-...	SL7/4-FW-T 171455	1 off																								
Tool for replacing filament lamp																												
	–																											
	–	SL4-L-... SL7-L-...	SL7/4-BET 171294	1 off																								
Magnetic base including M20 cable gland																												
	For vertical mounting, insulated material																											
	–	SL4-PIB-100(250)(400) SL7-CB-100(250)(400)	SL7/4-MMS 172954	1 off																								
<table border="1"> <thead> <tr> <th>Lifespan</th> <th>Rated operating voltage U_e</th> <th>Power</th> <th>For use with</th> <th>Part no. Article no.</th> <th>Std. pack</th> </tr> </thead> <tbody> <tr> <td rowspan="4"></td> <td colspan="5">Filament lamp</td> </tr> <tr> <td rowspan="4">> 3000 h</td> <td>12 V</td> <td rowspan="4">4 W</td> <td rowspan="4">SL4-L-...</td> <td>SL4-L12 171382</td> <td rowspan="4">1 off</td> </tr> <tr> <td>24 V</td> <td>SL4-L24 171383</td> </tr> <tr> <td>120 V</td> <td>SL4-L120 171384</td> </tr> <tr> <td>230 V</td> <td>SL4-L230 171385</td> </tr> </tbody> </table>					Lifespan	Rated operating voltage U_e	Power	For use with	Part no. Article no.	Std. pack		Filament lamp					> 3000 h	12 V	4 W	SL4-L-...	SL4-L12 171382	1 off	24 V	SL4-L24 171383	120 V	SL4-L120 171384	230 V	SL4-L230 171385
Lifespan	Rated operating voltage U_e	Power	For use with	Part no. Article no.	Std. pack																							
	Filament lamp																											
	> 3000 h	12 V	4 W	SL4-L-...	SL4-L12 171382	1 off																						
		24 V			SL4-L24 171383																							
		120 V			SL4-L120 171384																							
230 V		SL4-L230 171385																										

System overview

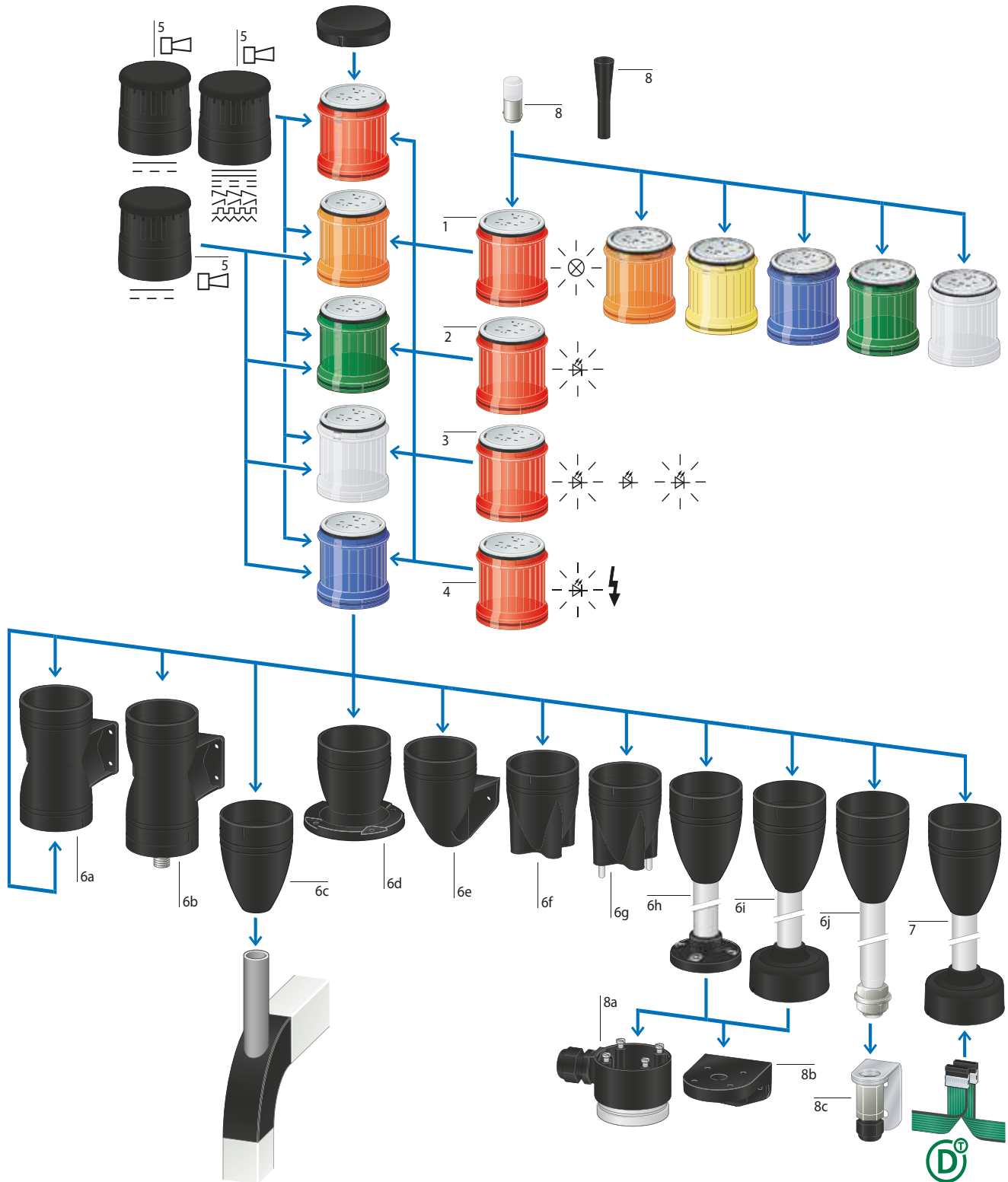

5

WWW.TM2A.PT info@tm2a.pt

WWW.TM2A.PT info@tm2a.pt

Module for filament lamp, continuous light 1

Without light element (filament lamp with BA15d socket)
 Easy mounting with bayonet mount
 Modules can be arranged in any order
 Max. 2 x 5 modules that can be actuated individually (two with base module SL7-CB-D only)
 Degree of protection IP66
 Operating mode: 100% DF (duty factor)
 → Page 163

Module with LED, continuous light 2

Easy mounting with bayonet mount
 Modules can be arranged in any order
 Max. 2 x 5 modules that can be actuated individually (two with base module SL7-CB-D only)
 Degree of protection IP66
 Operating mode: 100% DF (duty factor)
 → Page 163

Module with LED, flashing light 3

Easy mounting with bayonet mount
 Modules can be arranged in any order
 Max. 2 x 5 modules that can be actuated individually (two with base module SL7-CB-D only)
 Degree of protection IP66
 Operating mode: 100% DF (duty factor)
 Flashing frequency 2 Hz
 → Page 161

Module with LED, strobe light 4

With a fixed flashing frequency 1.4 Hz
 With LED for effective signaling effect with various flashing sequences (flashing frequency 1 - 2.6 Hz)
 Easy mounting with bayonet mount
 Modules can be arranged in any order
 Max. 2 x 5 modules that can be actuated individually (two with base module SL7-CB-D only)
 Degree of protection IP66
 Operating mode: 100% DF (duty factor)
 → Page 162

Acoustic module 5

Easy mounting with bayonet mount
 Set up as topmost module
 Max. 2 x 1 module that can be actuated individually (two with base module SL7-CB-D only)
 Degree of protection IP66
 Permanently integrated cover plate
 Operating mode: 100% DF (duty factor)
 Sound pressure 80 dB, frequency 4000 Hz
 → Page 164

Acoustic module 5a

Continuous tone or pulsed tone - adjustable with internal dip switches
 Frequency: 2800 Hz
 → Page 164

Acoustic module 5b

Multi-tone (8 tones) - adjustable with internal dip switch
 Frequency 500 - 2700 Hz
 → Page 164

Acoustic module 5b

Continuous tone or pulsed tone - can be actuated externally; takes up 2 inputs (2 modules)
 Frequency: 2800 Hz
 → Page 164

Base module for mounting on both sides 6a

Easy mounting with bayonet mount
 Degree of protection IP66
 With cover plate
 With Push in terminals
 → Page 166

Base module for vertical mounting on one sides 6b

Plug-in connection M22
 → Eaton Online Catalog

Base module can hold tubes 6c

→ Page 165

Base module with external fixing holes 6d

→ Page 165

Base module one-sided with bracket 6e

→ Page 166

Base module with internal (on the inside) fixing holes 6f

→ Page 165

Base module with built-in (pre-assembled) fixing screws 6g

→ Page 165

Base module with aluminium tube and plastic foot 6h

Aluminium tube 100 mm, 250 mm or 400 mm
 → Page 165

Base module with base adapter for slipping onto place (rapid mounting and wiring system) 6i

Aluminium tube 100 mm, 250 mm or 400 mm
 → Page 165

Base module with aluminum tube and screw fixing 6j

Aluminium tube 100 mm, 250 mm or 400 mm
 → Page 165

Base module with base adapter for slipping onto place (rapid mounting and wiring system) and SmartWire-DT connection 7

Aluminium tube 100 mm
 → Page 165

Accessories 8

Magnetic base including M20 cable gland 8a

For vertical mounting
 → Page 157

Mounting bracket 8b

For vertical mounting
 → Page 157

Accessories 8c

Tool for replacing filament lamp
 Filament lamp
 → Page 157

5.4

























Signal towers

SL7 – Complete devices, light modules

Moeller series

Product selection

5

	Rated operating voltage U_e V	Number of modules	Color	Function	Part no. Article no.	Std. pack	
Complete units							
 <p>Continuous light LED IP66 Base module with foot and 100 mm spacer</p>	24 V AC/DC	2			SL7-100-L-RG-24LED	1 off	
		3			SL7-100-L-RYG-24LED	171425	
Module with LED							
 <p>Continuous light IP66</p>	24 V AC/DC				SL7-L24-B	1 off	
					SL7-L24-G		
					SL7-L24-R		
					SL7-L24-W		
					SL7-L24-Y		
					SL7-L24-A		
			110/120 V AC				SL7-L120-B
							SL7-L120-G
							SL7-L120-R
							SL7-L120-W
							SL7-L120-Y
							SL7-L120-A
	230/240 V AC		SL7-L230-B				
			SL7-L230-G				
			SL7-L230-R				
			SL7-L230-W				
			SL7-L230-Y				
			SL7-L230-A				

WWW.TM2A.PT info@tm2a.pt

WWW.TM2A.PT info@tm2a.pt



Module with LED

Flashing light
IP66
2 Hz

Rated operating
voltage
 U_e
V

Color

Function

Part no.
Article no.

Std. pack

24 V AC/DC



SL7-BL24-B
171439

1 off



SL7-BL24-G
171440



SL7-BL24-R
171441



SL7-BL24-W
171442



SL7-BL24-Y
171388



SL7-BL24-A
171389

110/120 V AC



SL7-BL120-B
171390



SL7-BL120-G
171391



SL7-BL120-R
171392



SL7-BL120-W
171393



SL7-BL120-Y
171394



SL7-BL120-A
171395

230/240 V AC



SL7-BL230-B
171396



SL7-BL230-G
171397



SL7-BL230-R
171398



SL7-BL230-W
171399



SL7-BL230-Y
171400



SL7-BL230-A
171401

5.4

Signal towers

SL7 – Light modules

Moeller series



























5









	Rated operating voltage U_e V	Color	Function	Part no. Article no.	Std. pack
Module with LED					
Strobe light IP66 1.4 Hz	24 V AC/DC			SL7-FL24-B 171402	1 off
				SL7-FL24-G 171403	
				SL7-FL24-R 171404	
				SL7-FL24-W 171405	
				SL7-FL24-Y 171406	
				SL7-FL24-A 171407	
	110/120 V AC		SL7-FL120-B 171408		
			SL7-FL120-G 171409		
			SL7-FL120-R 171410		
			SL7-FL120-W 171411		
			SL7-FL120-Y 171412		
			SL7-FL120-A 171413		
	230/240 V AC		SL7-FL230-B 171414		
			SL7-FL230-G 171415		
			SL7-FL230-R 171416		
			SL7-FL230-W 171417		
			SL7-FL230-Y 171418		
			SL7-FL230-A 171419		



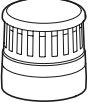

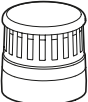
WWW.TM2A.PT info@tm2a.pt

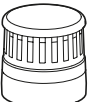
WWW.TM2A.PT info@tm2a.pt

	Rated operating voltage U_e V	Color	Function	Part no. Article no.	Std. pack
Module with high power LED					
 <p>Continuous light IP66 High-performance LED for maximum signaling effect High Performance LED</p>	24 V AC/DC			SL7-L24-B-HP 171427	1 off
				SL7-L24-G-HP 171428	
				SL7-L24-R-HP 171429	
				SL7-L24-W-HP 171430	
				SL7-L24-Y-HP 171431	
				SL7-L24-A-HP 171432	
<p>Strobe light IP66 High-performance LED for maximum signaling effect High Performance LED 1.4 Hz</p>	24 V AC/DC			SL7-FL24-B-HP 171420	
				SL7-FL24-G-HP 171421	
				SL7-FL24-R-HP 171422	
				SL7-FL24-W-HP 171423	
				SL7-FL24-Y-HP 171273	
				SL7-FL24-A-HP 171274	
<p>Multistrobe light IP66 High-performance LED for maximum signaling effect High Performance LED 1 - 2.6 Hz</p>	24 V AC/DC			SL7-FL24-B-HPM 171275	
				SL7-FL24-G-HPM 171276	
				SL7-FL24-R-HPM 171277	
				SL7-FL24-W-HPM 171278	
				SL7-FL24-Y-HPM 171279	
				SL7-FL24-A-HPM 171280	
Module for filament lamp					
 <p>Continuous light IP66 Without lamp Filament lamp max. 7 W Filament lamp → Page 166</p>	< 250 V AC/DC			SL7-L-B 171433	1 off
				SL7-L-G 171434	
				SL7-L-R 171435	
				SL7-L-W 171436	
				SL7-L-Y 171437	
				SL7-L-A 171438	

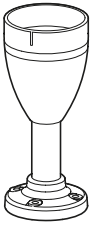
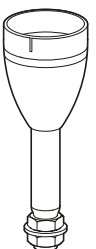
5

Rated operating voltage U_e V	Rated operational current I_e mA	Color	Function	Type of tone	Part no. Article no.	Std. pack
Acoustic modules						
 <p>Continuous tone or pulsed tone, adjustable with internal dip switches. Sound pressure 100 db, adjustable with internal potentiometer $f = 2800$ Hz Place only at the highest position on a pillar IP66</p>						
24 V AC/DC	Max. 92	■			SL7-AP24 171281	1 off
110/120 V AC	Max. 41	■			SL7-AP120 171282	
230/240 V AC	Max. 43	■			SL7-AP230 171283	
 <p>Continuous tone or pulsed tone, external actuation. Assigned two inputs (2 modules). Sound pressure 100 db, adjustable with internal potentiometer $f = 2800$ Hz Place only at the highest position on a pillar IP66</p>						
24 V AC/DC	Max. 92	■			SL7-AP24-E 171284	1 off
110/120 V AC	Max. 41	■			SL7-AP120-E 171285	
230/240 V AC	Max. 43	■			SL7-AP230-E 171286	
 <p>Multi-tone; 8 tones, adjustable with internal dip switch. Sound pressure 100 db, adjustable with internal potentiometer $f = 500 - 2700$ Hz Place only at the highest position on a pillar IP66</p>						
24 V AC/DC	Max. 115	■			SL7-AP24-M 171287	1 off
110/120 V AC	Max. 45	■			SL7-AP120-M 171288	
230/240 V AC	Max. 43	■			SL7-AP230-M 171289	
Customized complete unit						
Order please enquire						
-	-	-	-	-	SL7-COMBINATION 2011955	1 off

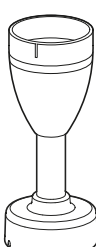
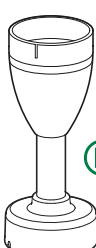
	Tube length	Color	For use with	Part no. Article no.	Std. pack
Base modules					
For horizontal mounting including cover max. 5 modules					
	100 mm	Black Aluminum color tube	SL7-L-... SL7-BL-... SL7-FL-... SL7-AP-...	SL7-CB-100 171443	1 off
	250 mm			SL7-CB-250 171444	
	400 mm			SL7-CB-400 171445	
	800 mm			SL7-CB-800 177312	
	100 mm			SL7-CB-T-100 171452	
	250 mm			SL7-CB-T-250 171453	
	400 mm			SL7-CB-T-400 171454	
	800 mm			SL7-CB-T-800 178460	
	–	Black		SL7-CB-IMH 171447	
	–			SL7-CB-IMS 171448	
	–			SL7-CB-EMH 171449	
	–			SL7-CB-TM 179987	
	100 mm	Black Aluminum color tube		SL7-FMS-100 171456	
	250 mm			SL7-FMS-250 171457	
	400 mm			SL7-FMS-400 171458	
	800 mm			SL7-FMS-800 178462	
	100 mm			SL7-SWD 171459	
Base with base adapter for slipping onto place (rapid mounting and wiring system) Blade terminal SWD4-8MF2 max. 0.3 A per module External power supply connectable (24 V DC) Parameterizable with SWD-Assist (planning and ordering help)					

5.4

Signal towers

SL7 – Base modules, accessories

Moeller series

5

	Color	For use with	Part no. Article no.	Std. pack
--	-------	--------------	-------------------------	-----------

Base modules



For vertical mounting, with cover, max. 5 modules

One-sided base with bracket Spring-cage terminals	Black	SL7-L-... SL7-BL-... SL7-FL-... SL7-AP-...	SL7-CB-FW 171450	1 off
--	-------	---	----------------------------	-------



For vertical mounting on both sides, with cover, max. 2 x 5 modules

Base with external fixing holes Spring-cage terminals	Black	SL7-L-... SL7-BL-... SL7-FL-... SL7-AP-...	SL7-CB-D 171451	1 off
--	-------	---	---------------------------	-------



Mounting bracket

For vertical mounting, insulated material

–	–	SL4-PIB-... SL7-CB-...	SL7/4-FW 171446	1 off
---	---	---------------------------	---------------------------	-------



Including mounting bracket M20 cable gland

For vertical mounting, metal

–	–	SL4-PIB-T... SL7-CB-T...	SL7/4-FW-T 171455	1 off
---	---	-----------------------------	-----------------------------	-------



Tool for replacing filament lamp

–	–	SL4-L... SL7-L...	SL7/4-BET 171294	1 off
---	---	----------------------	----------------------------	-------

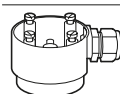

Magnetic base including M20 cable gland

For vertical mounting, insulated material

–		SL4-PIB-100(250)(400) SL7-CB-100(250)(400)	SL7/4-MMS 172954	1 off
---	--	---	----------------------------	-------

Lifespan	Rated operating voltage U_e	Power	For use with	Part no. Article no.	Std. pack
----------	----------------------------------	-------	--------------	-------------------------	-----------



Filament lamp

Ba 15d socket

> 3000 h	12 V	5 W	SL7-L-...	SL7-L12 171290	1 off
	24 V	6.5 W		SL7-L24 171291	
	120 V	7 W		SL7-L120 171292	
	230 V	6.5 W		SL7-L230 171293	

Technical data

SL4-...

General	
Standards	IEC/EN 60947-5-1, UL508
Climatic proofing	Damp heat, constant, to IEC 60068-2-78 Damp heat, cyclic, to IEC 60069-2-30
Mounting position	any
Mechanical shock resistance	g > 15 according to IEC 60068-2-27 Shock duration 11 ms Half sinus
IEC degree of protection	IP66 IEC/EN 60529
Degree of protection UL	Type 4, 4X, 13
Material	Enclosure: Polycarbonate (PC), black Cap: Polycarbonate (PC)
Color of lamp hood	blue, green, red, clear, yellow, orange, amber
Ambient air temperature	°C -30 - +60
Number of signal elements	Max. 5 with standard base Max. 10 with base for mounting on both sides
Terminal capacities	
Solid/flexible	mm ² 0.2 - 1.5
Solid/flexible, with ferrule	mm ² 0.25 - 1.5
Flexible with ferrule with plastic collar	mm ² 0.25 - 0.75
	AWG 24 - AWG 16
Contacts	
Rated impulse withstand voltage	U_{imp} V AC 4000
Rated insulation voltage	U_i V 250
Overvoltage category/degree of pollution	III/3

	SL4-L...-...	SL4-BL...-...	SL4-FL...-...	SL4-FL24...-M	SL4-L...
Light modules					
Type of light	Continuous light	Flashing light	Strobe light	Multistrobe light	Continuous light
Lamp	LED				Filament lamp max. 4 W
Lamp holder	-	-	-	-	Ba15d
Flashing/strobe frequency	-	2 Hz	1.4 Hz	1 - 2.6 Hz	-
Transmission angle	360°				
Leakage current	A < 0.003				
Current/power consumption					
24 V AC/DC	A 0.022 - 0.033	0.028 - 0.036	0.035 - 0.065	0.048 - 0.068	-
110/120 V AC	A 0.030	0.030	0.10	-	-
230/240 V AC	A 0.030	0.030	0.10	-	-
Power consumption	-	-	-	-	Max. 4 W with the specified voltages
Voltage range	24 V AC/DC ± 10 % 110/120 V AC ± 10 % 230/240 V AC ± 10 %			24 V AC/DC ± 10 %	up to 250 V AC/DC
Lifespan	h > 100000				
Weight	g 45				

SL4-AP...

Acoustic modules

Type of tone	Continuous or pulsed tone	
Types of sound	2 versions, → table of sound types	
Sound setting	built-in, 1 pole DIP	
Sound pressure	dB	80
Sound pressure level adjustment	-	
Sound pressure can be lowered to a minimum of	-	
Transmission angle	360°	
Current/power consumption		
24 V AC/DC	A	0.039
110/120 V AC	A	0.021
230/240 V AC	A	0.021
Voltage range	24 V AC/DC ± 10 % 110/120 V AC ± 10 % 230/240 V AC ± 10 %	
Weight	g	43

	Type of tone	Frequency Hz	Plot	Repeat rate	Special application	Max. volume dB
Table of sound types						
SL4-AP...	Continuous tone	approx. 4000	_____	-	-	80
	Pulse tone	approx. 4000	— — —	approx. 2 Hz	-	80

SL7-...

General	
Standards	IEC/EN 60947-5-1, UL508
Climatic proofing	Damp heat, constant, to IEC 60068-2-78 Damp heat, cyclic, to IEC 60069-2-30
Mounting position	any
Mechanical shock resistance	g > 15 according to IEC 60068-2-27 Shock duration 11 ms Half sinus
IEC degree of protection	IP66 IEC/EN 60529
Degree of protection UL	Type 4, 4X, 13
Material	Enclosure: Polycarbonate (PC), black Cap: Polycarbonate (PC)
Color of lamp hood	blue, green, red, clear, yellow, orange, amber
Ambient air temperature	°C -30 - +60
Number of signal elements	Max. 5 with standard base Max. 10 with base for mounting on both sides
Terminal capacities	
Solid/flexible	mm ² 0.13 - 2.5
Flexible with ferrule with plastic collar	mm ² 0.25 - 1.5
	AWG 24 - AWG 14
Contacts	
Rated impulse withstand voltage	U_{imp} V AC 4000
Rated insulation voltage	U_i V 250
Overtoltage category/degree of pollution	III/3

SL7-L-... SL7-BL-... SL7-FL-... SL7-L24-...-HP SL7-FL24-...-HP SL7-FL24-...-HPM SL7-L-...

Light modules		SL7-L-...	SL7-BL-...	SL7-FL-...	SL7-L24-...-HP	SL7-FL24-...-HP	SL7-FL24-...-HPM	SL7-L-...
Type of light		Continuous light	Flashing light	Strobe light	Continuous light	Strobe light	Multistrobe light	Continuous light
Lamp		LED			High Performance LED			Filament lamp max. 7 W
Lamp holder		-	-	-	-	-	-	Ba15d
Flashing/strobe frequency		-	2 Hz	1.4 Hz	-	1.4 Hz	1 - 2.6 Hz	-
Transmission angle		360°						
Leakage current	A	< 0.003						
Current/power consumption								
24 V AC/DC	A	0.049 - 0.054	0.058	0.130 - 0.135	0.170 - 0.200	0.260 - 0.265	0.260 - 0.265	-
110/120 V AC	A	0.028 - 0.031	0.028 - 0.030	0.010	-	-	-	-
230/240 V AC	A	0.027 - 0.028	0.030 - 0.031	0.010	-	-	-	-
Power consumption		-	-	-	-	-	-	Max. 7 W with the specified voltages
Voltage range		24 V AC/DC ± 10 % 110/120 V AC ± 10 % 230/240 V AC ± 10 %			18-30 V DC/18-26 V AC			up to 250 V AC/DC
Lifespan	h	> 100000			> 50000			> 3000
Weight	g	80						

	SL7-AP...	SL7-AP...-E	SL7-AP...-M
Acoustic modules			
Type of tone	Continuous or pulsed tone		Continuous or pulsed tone 8 types of sound
Types of sound	2 versions, → table of sound types		8 versions, → table of sound types
Sound setting	Built-in, 1 pole DIP	Can be externally actuated	Built-in, 3 pole DIP
Sound pressure	dB	100	
Sound pressure level adjustment	Built-in, potentiometer		
Sound pressure can be lowered to a minimum of	88 dB		
Transmission angle	360°		
Current/power consumption			
24 V AC/DC	A	0.092	0.115
110/120 V AC	A	0.041	0.045
230/240 V AC	A	0.043	0.043
Voltage range	24 V AC/DC ± 10 % 110/120 V AC ± 10 % 230/240 V AC ± 10 %		
Weight	g	102	

	Type of tone	Frequency Hz	Plot	Repeat rate	Special application	Max. volume dB
Table of sound types						
SL7-AP...	Continuous tone	approx. 2800		–	–	100
	Pulse tone	approx. 2800		approx. 2 Hz	–	100
SL7-AP...-E	Continuous tone	approx. 2800		–	–	100
	Pulse tone	approx. 2800		approx. 2 Hz	–	100
SL7-AP...-M	Continuous tone	2700		–	–	100
	Continuous tone	1350		–	–	100
	Pulse tone	2700		250 ms on, 250 ms off	–	100
	Pulse tone	1350		250 ms on, 250 ms off	–	100
	Falling	1200 - 500		1 Hz	Evacuation, Germany, DIN 3304-3	98
	Rising	500 - 1200		Rising 3 s, 0.5 s off	Netherlands NEN 2575:2000	98
	Alternating	800 - 1000		2 Hz	–	94
	Rising/falling	500 - 1500		10 Hz	–	94

Dimensions

Complete units

SL4-100-L-RG-24LED

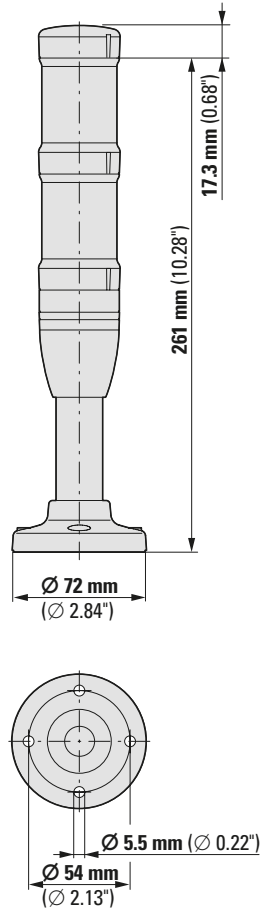

SL4-100-L-RYG-24LED

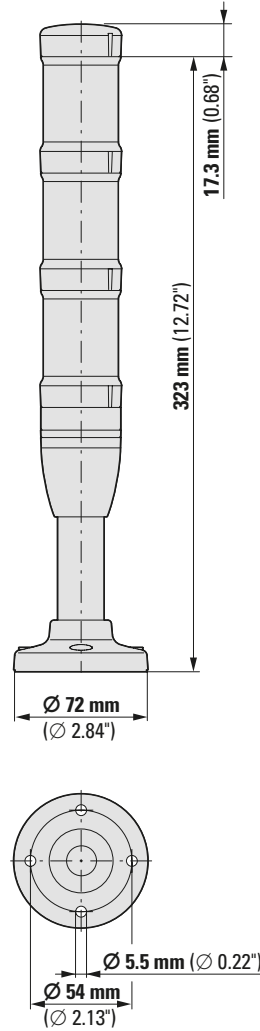

Light modules

SL4-(B)(F)L ...

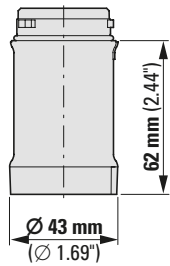

Acoustic modules

SL4-AP...

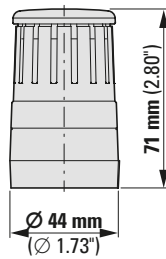

WWW.TM2A.PT info@tm2a.pt

WWW.TM2A.PT info@tm2a.pt

5.6

Signal towers

SL4 – Dimensions

Moeller series

Base modules

SL4-PIB-...

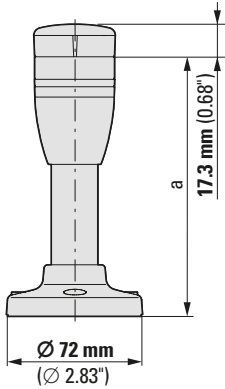

Part no.	a mm (inch)
SL4-PIB-100	136 (3.53)
SL4-PIB-250	286 (11.26)
SL4-PIB-400	436 (17.16)
SL4-PIB-800	836 (32.91)

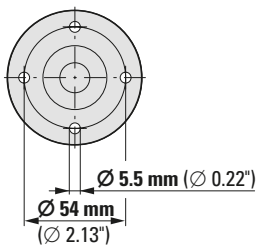

SL4-PIB-T-...

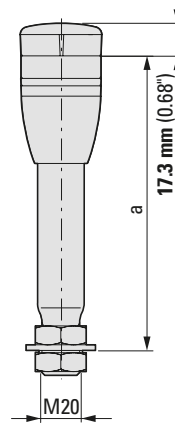

Part no.	a mm (inch)
SL4-PIB-T-100	150 (5.90)
SL4-PIB-T-250	300 (11.81)
SL4-PIB-T-400	450 (17.72)
SL4-PIB-T-800	850 (33.46)

SL4-PIB-D

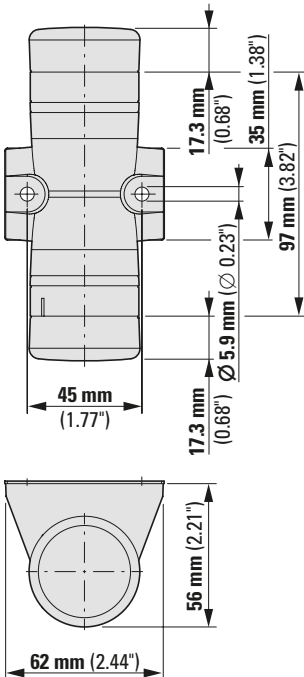

SL4-PIB-EMH

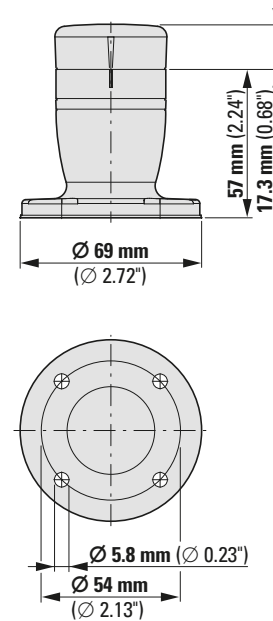

5

WWW.TM2A.PT info@tm2a.pt

WWW.TM2A.PT info@tm2a.pt

Base modules

SL4-PIB-FW

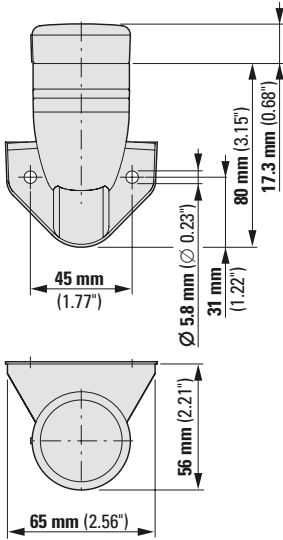

SL4-PIB-IMH

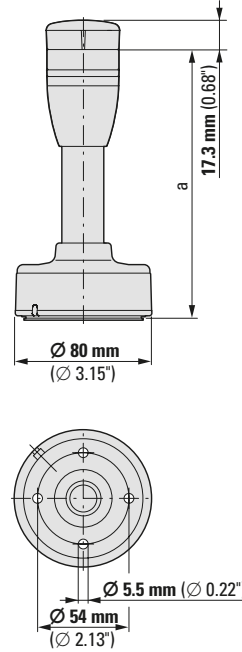

SL4-PIB-IMS

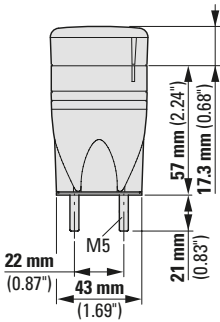

SL4-FMS-...

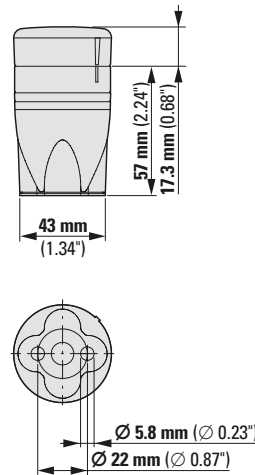

Part no.	a mm (inch)
SL4-FMS-100	157 (6.18)
SL4-FMS-250	307 (12.09)
SL4-FMS-400	457 (17.99)
SL4-FMS-800	857 (33.74)

SL4-PIB-TM

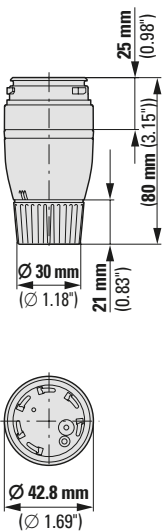

WWW.TM2A.PT info@tm2a.pt

WWW.TM2A.PT info@tm2a.pt

Base module for connecting to SmartWire-DT®

SL4-SWD

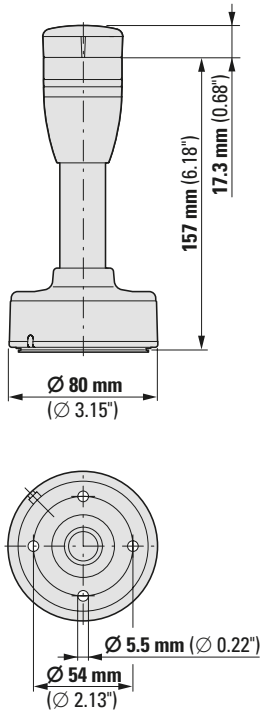

Mounting bracket

SL7/4-FW

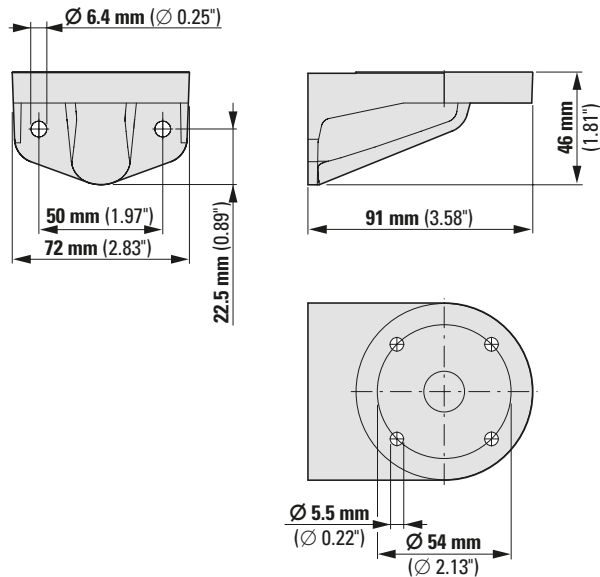

SL7/4-FW-T

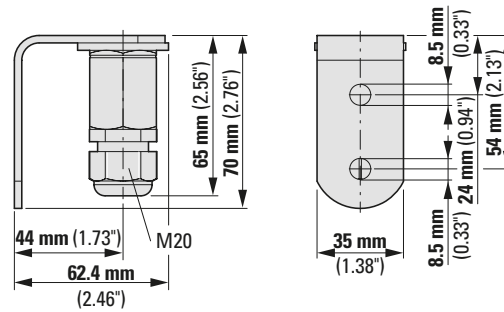

Filament lamp

SL4-L12(24)(120)(230)

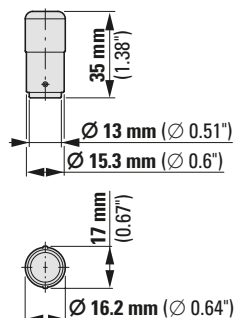

Tool for replacing filament lamp

SL7/4-BET

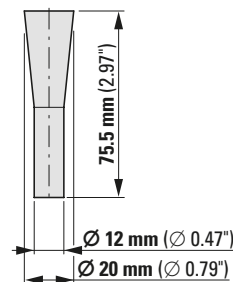

Complete units

SL7-100-L-RG-24LED

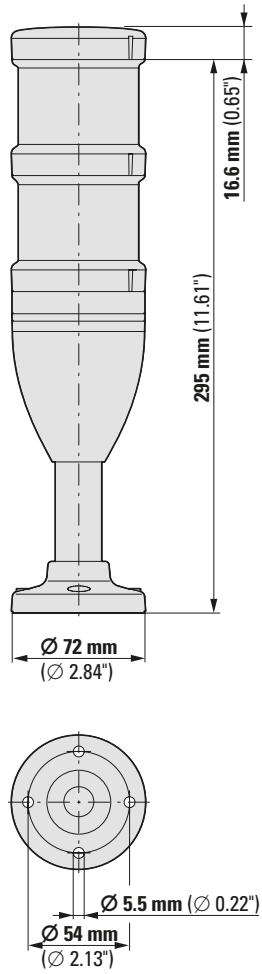

SL7-100-L-RYG-24LED

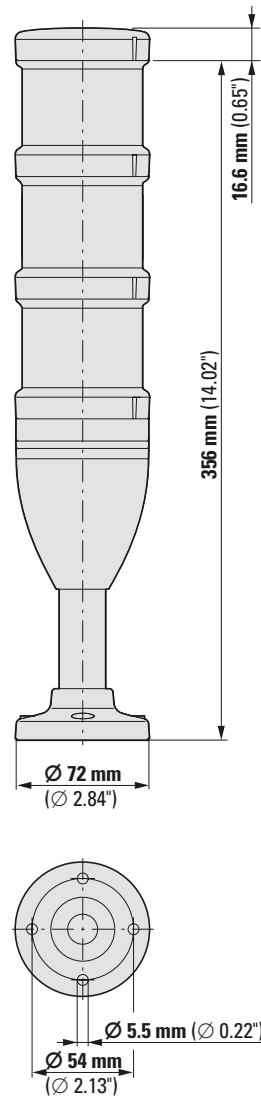

5

WWW.TM2A.PT info@tm2a.pt

WWW.TM2A.PT info@tm2a.pt

Light modules

SL7-(B)(F)L ...

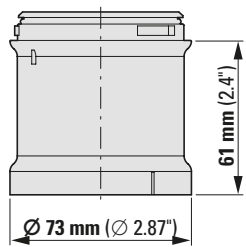

Acoustic modules

SL7-AP...

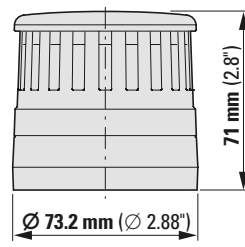

5.6

Signal towers

SL7 – Dimensions

Moeller series

Base modules

SL7-CB-...

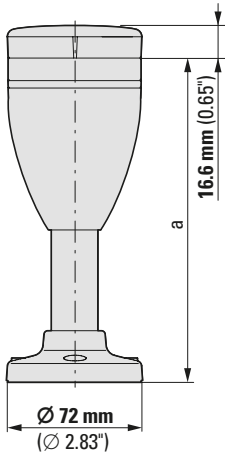

Part no.	a mm (inch)
SL7-CB-100	171 (6.73)
SL7-CB-250	321 (12.64)
SL7-CB-400	471 (18.54)
SL7-CB-800	871 (34.29)

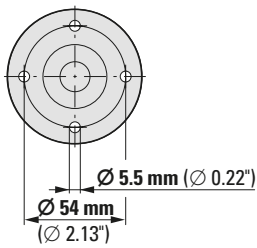

SL7-CB-T-...

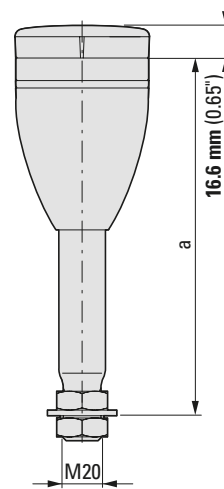

Part no.	a mm (inch)
SL7-CB-T-100	190 (7.48)
SL7-CB-T-250	340 (13.38)
SL7-CB-T-400	490 (19.29)
SL7-CB-T-800	890 (35.04)

SL7-CB-D

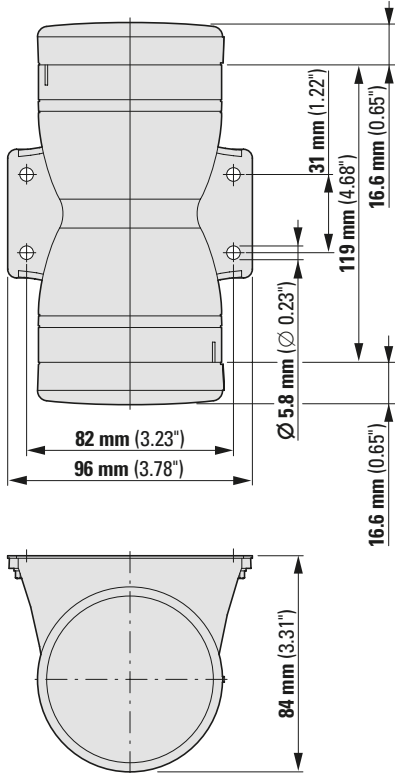

SL7-CB-EMH

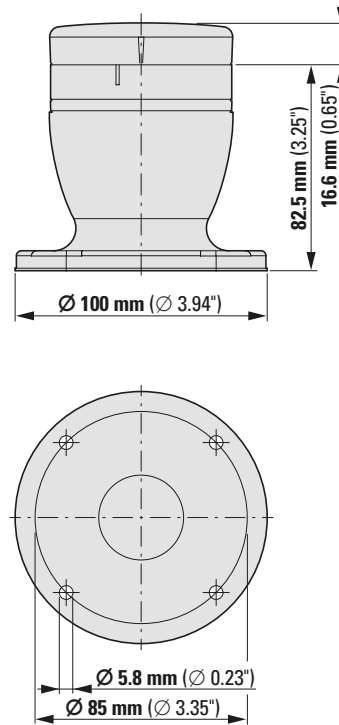

5

WWW.TM2A.PT
info@tm2a.pt

WWW.TM2A.PT
info@tm2a.pt

WWW.TM2A.PT
info@tm2a.pt

WWW.TM2A.PT
info@tm2a.pt

Base modules

SL7-CB-FW

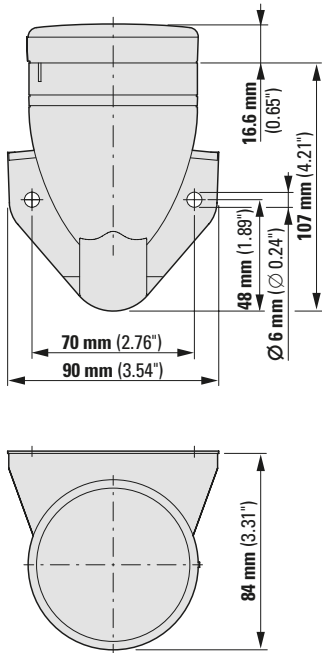

SL7-CB-IMH

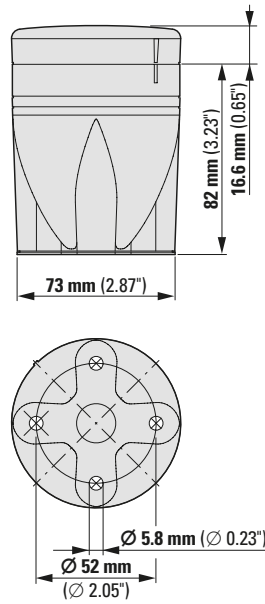

SL7-CB-IMS

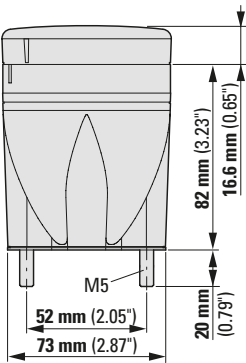

SL7-FMS-...

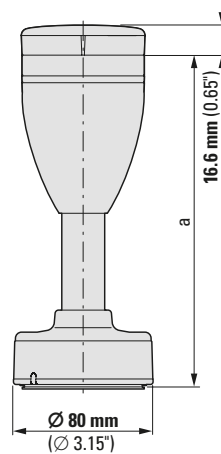

Part no.	a mm (inch)
SL7-FMS-100	192 (7.55)
SL7-FMS-250	342 (13.46)
SL7-FMS-400	492 (19.37)
SL7-FMS-800	892 (35.12)

SL7-CB-TM

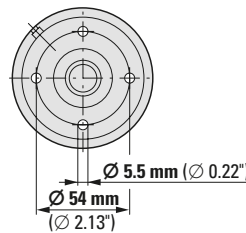
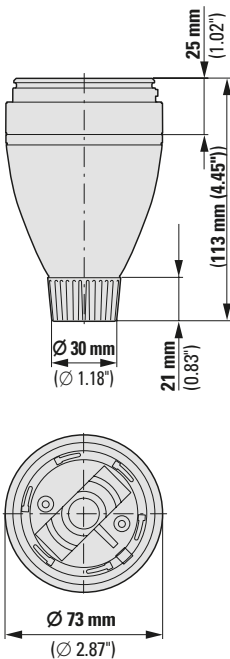

5.6

Signal towers

SL7 – Dimensions

Moeller series

Base module for connecting to SmartWire-DT®

SL7-SWD

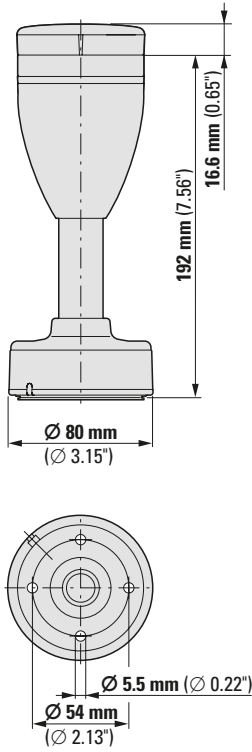

Magnetic base including M20 cable gland

SL7/4-MMS

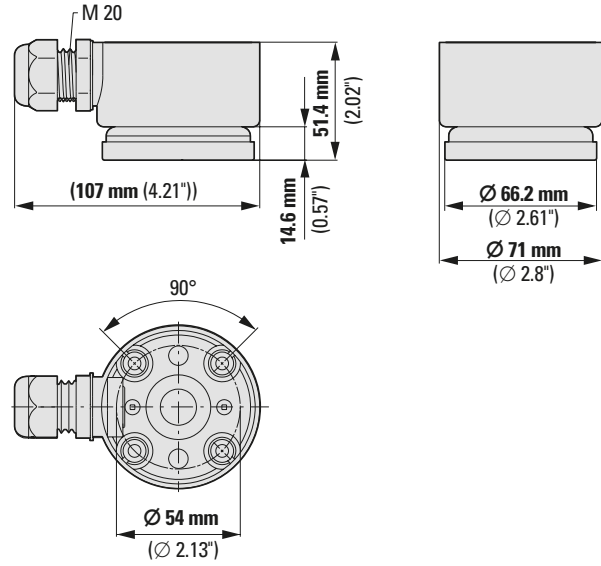

Mounting bracket

SL7/4-FW

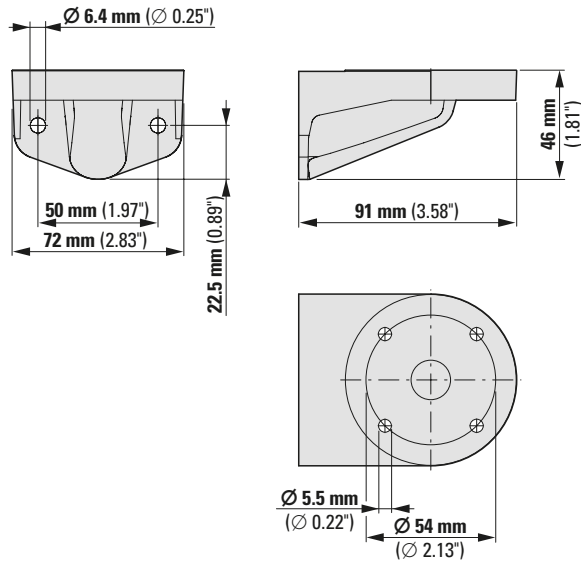

SL7/4-FW-T

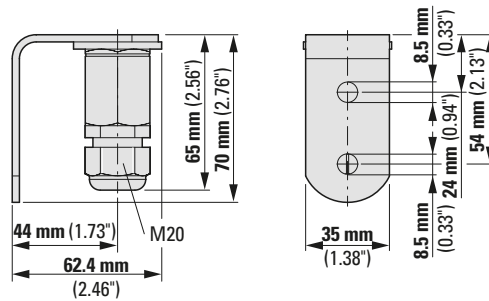

Filament lamp

SL7-L12(24)(120)(230)

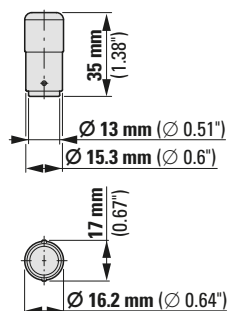

Tool for replacing filament lamp

SL7/4-BET

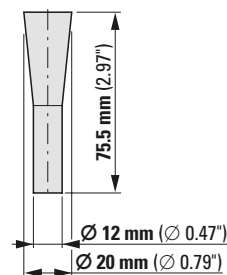

5

WWW.TM2A.PT info@tm2a.pt

WWW.TM2A.PT info@tm2a.pt

WWW.TM2A.PT info@tm2a.pt

WWW.TM2A.PT info@tm2a.pt

WWW.TM2A.PT info@tm2a.pt

WWW.TM2A.PT info@tm2a.pt

Build it in.



The RMQ C22 Series: Powerful Functionality with a Compact Design



Download product range catalog „C22 compact portfolio“ www.eaton.com

RMQ C22 pilot devices are not only characterized by compact dimensions and a conventional screw connection, but also feature the same design that has made units such as our M22 modular pushbuttons stand the test of time. C22 devices are built as monolithic units with an “all-in-one” focus that combines contacts and lamps in a single housing.

In addition to a comprehensive selection of operators and selector switches, the C22 product portfolio also includes emergency stop buttons in a variety of versions, including lockable units.

C22 devices combine multiple components in a single device. This compact design means that only one article no. is required, making product selection and ordering much easier and faster. On top of this, these devices have an extremely long mechanical life and are suitable for worldwide use.

Build it in.



Galileo



XV HMI/PLC: Easy and Convenient Operation for a Rapidly Changing World



Eaton's XV HMI PLC touch panels comprise a range of products that has been fine-tuned to perfection and can be seamlessly integrated into a variety of performance classes. Capacitive, resistive, and infrared touch technology devices are available in display sizes ranging from 3.5" to 15" with a plastic, metal, or stainless steel housing. Moreover, an on-board SmartWire-DT master interface makes it possible to achieve significant savings all the way from the hardware planning stage through commissioning.

With its multi-touch display HMI PLC units, the XV300 series has opened a whole new world of intuitive and convenient operation. These panels feature the same ease of use as modern mobile devices, such as smartphones and tablets, but upgraded for industrial applications.

Combined with a small mounting depth, the completely flat, anti-reflective, and tempered glass panel in XV300 units ensures that these devices not only meet the most demanding design and hygiene requirements, but are also ideal for use in harsh industrial environments.

WWW.TM2A.PT info@tm2a.pt

WWW.TM2A.PT info@tm2a.pt

WWW.TM2A.PT info@tm2a.pt

WWW.TM2A.PT info@tm2a.pt

Build it in.



Control and Signaling in Hazardous Locations



For more information
please refer to the Crouse-Hinds
main catalog (Part 2)

Download at:
www.crouse-hinds.de/en
Products and Brochures



CEAG products from Eaton's Crouse-Hinds series include signal and control devices for a reliable operation in harsh environments.

Enclosures in high degree of protection (IP66) are available in impact-resistant plastic, glass fiber-reinforced polyester, light alloy or stainless steel with a high resistance to chemicals.

The portfolio includes explosion-protected built-in components designed for panel mounting and use in zones 1 and 2. In addition to control units, it also includes signal lamps, pushbuttons, and switches. Moreover, the switch and pushbutton top parts can be combined with various contact systems.

Control units are available in enclosure solutions that make them suitable for use in zone 1, 2, 21, and 22. Up to three built-in components can be installed in each enclosure. Even the light alloy and stainless steel enclosures are particularly characterized by high mechanical and thermal resistances.

Explosion-protected built-in components

The use of CEAG signal and control devices for panel mounting applications is approved for panel thicknesses of up to 5 mm. The panel built-in devices, signal lamps, pushbutton, and switch bases can be installed in a matter of seconds by using the bayonet mount on the devices. Single-wire installation is easy and clear. Slip-on strain-relief fittings and protective caps for the cable connections can be retrofitted on all panel mounting devices, at which point the devices become fully certified units.

This approach eliminates the need to configure and keep spares of panel built-in devices with different cable lengths.

Built-in components for control units

The variety of built-in components available means that custom-tailored control units for specific customers can be put together within the scope of type examination. The switch and button top parts can be combined with a variety of contact systems as necessary.

Explosion-protected control units

Enclosure solutions made of low-temperature impact-resistant thermoplastic, high-quality die-cast aluminum (AlSi), or stainless steel (AISI 316) are available. The well-engineered design behind the plastic housing makes it possible to achieve an optimum cable connection thanks to the fact that the side panels are drawn deeper.

In order to make cable routing easier, the built-in components can be snapped out from the housing.

Mounting openings can be left unused so that certified genuine CEAG components can be retrofitted as necessary. In this case, the openings will be sealed at the factory with blanking elements.

Assortment

The explosion-protected pilot devices are available as pushbuttons, double pushbuttons, mushroom-head pushbuttons, emergency stop mushroom-head pushbuttons, key-operated pushbuttons and LED signal lamps with a number of designs. In addition, a variety of accessories, including label plates and protective caps, are available as well.

In the case of explosion-protected control units, the built-in components are installed inside an enclosure, making them suitable for use in zone 1 and 2 explosive gas areas and zone 21 and 22 explosive dust areas. The corresponding enclosures made of plastic, light alloy, or stainless steel feature a high degree of protection (IP66).

Explosion-protected built-in components

for zone 1 and 2



Eaton Crouse-Hinds products are suitable for use in harsh and demanding environmental conditions.



Quick and easy installation of built-in components in control panels.

Explosion-protected enclosure solutions

for zones 1, 2, 21 and 22



Our Service – Your Benefit

See More, Do More

- We increase your profits
- We improve your productivity and quality
- We reduce your total cost of ownership
- We simplify your sourcing and ordering processes
- You can focus on your core competencies
- Environmental benefit:
We minimize your packaging and transportation effort

VAS-EMEA@eaton.com

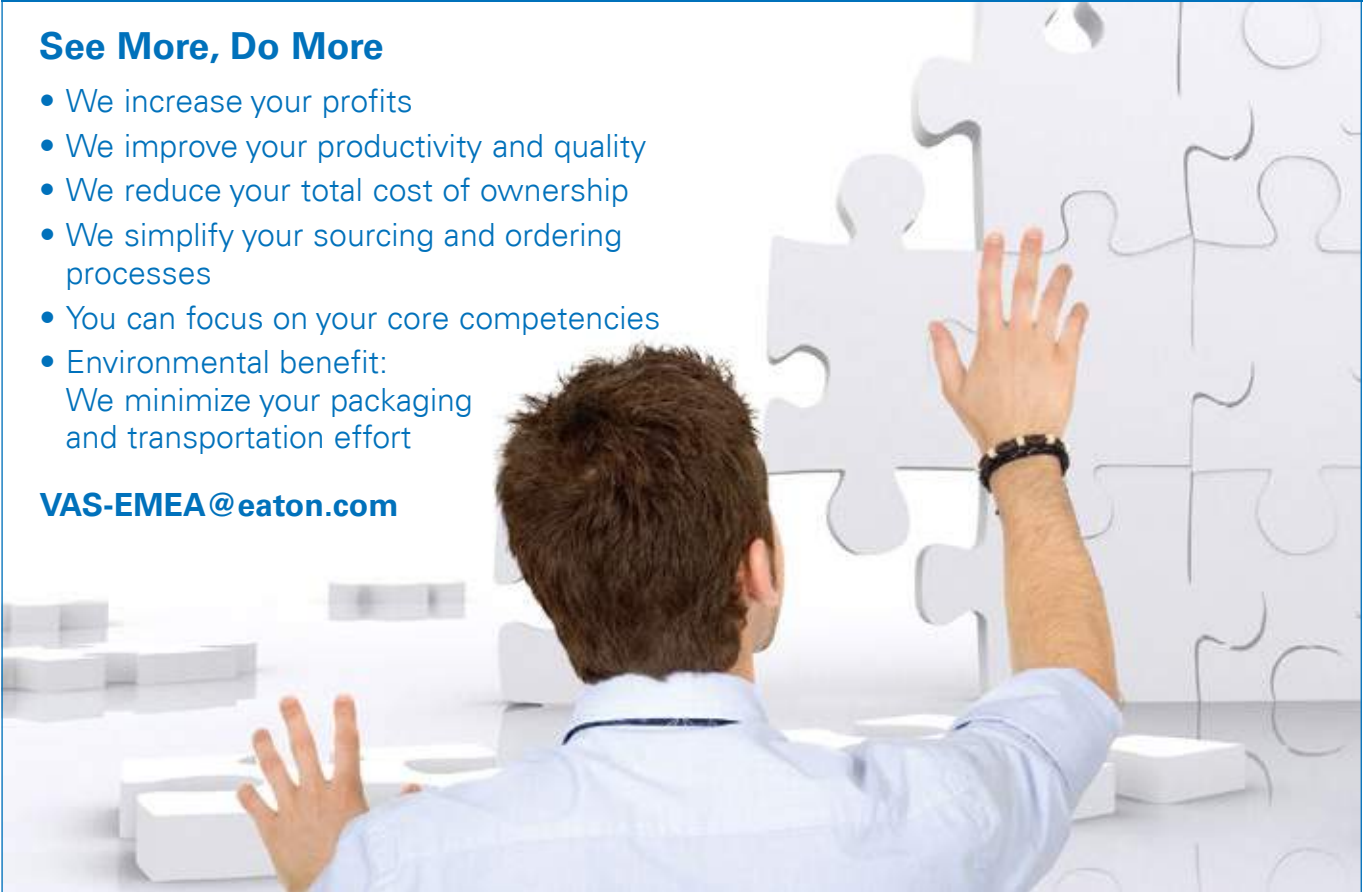

info@tm2a.pt

info@tm2a.pt

WWW.TM2A.PT

WWW.TM2A.PT

Basic Services

- Dispatch notification
- Customized labels / barcodes
- Kitting – all variations / different possibilities
- Customer-specific packaging

Warehouse Services

Integrated Solutions

- Product assemblies
- Product combinations incl. wiring
- Products in enclosures / on DIN-rail / mounting plate
- SmartWire-DT solutions
- Pre-programmed soft starters / HMI's / PLC's

Assemblies

Customized Solutions

- Workshops with Value Analysis/Value Engineering approach

Workshops / Innovation

With our Value Added Services you can save up to 40% of your costs!

To find the right contact person

At Eaton, we believe that building and maintaining strong relationships with our customers is something that deserves our undivided attention.

That is why you can rest assured knowing that you will be able to count on us for every project from the very start. Simply contact us to get personalized one-on-one advice. To quickly and easily find the appropriate contact, please refer to the contact addresses below.



In just a few steps, we will get you the contact information for the person or team in charge of support for your specific industry in your region.

To find the right contact person anywhere in the world, visit:

→ www.eaton.eu/contact

Eatons After Sales Service

Eaton is known for its unparalleled after-sales support for low-voltage switchgear, switchgear systems, and services. For more detailed information, as well as to view our terms and conditions, please visit www.eaton.eu/aftersales

Europe, Middle East, Africa24/7

Hotline

For immediate support please call +49 (0) 180 5 223822* (24/7). You will receive competent and fast, round the clock assistance, with unplanned machine and system stand stills, system malfunctions and device failures.

(* 0.14 Euro per minute from the Deutsche Telekom AG network)

Helpdesk

Eaton specialists: +49 (0) 228 602 3640 (Monday–Friday from 08:00–16:00 CET) or contact your local Eaton representative.

We offer extensive support from commissioning to application queries as well as in the area of fault analysis, which can also include remote diagnostics.

We can also offer you an individual consulting service contract which is tailor-made to suit your requirements.

If you would like to communicate your service queries in writing, please use the following e-mail address:

AfterSalesEGBonn@eaton.com

At Eaton, we're energized by the challenge of powering a world that demands more. With over 100 years experience in electrical power management, we have the expertise to see beyond today. From groundbreaking products to turnkey design and engineering services, critical industries around the globe count on Eaton.

We power businesses with reliable, efficient and safe electrical power management solutions. Combined with our personal service, support and bold thinking, we are answering tomorrow's needs today. Follow the charge with Eaton. **Visit eaton.eu.**

To contact an Eaton salesperson or local distributor/agent, please visit www.eaton.eu/electrical/customersupport



TM2A Soluções e Componentes Industriais
Rua Cidade de Viena 2, Parque Ind. Arneiro
2660-456 São Julião do Tojal
PORTUGAL
T: +351 219737330 F: +351 219737339
www.tm2a.pt info@tm2a.pt

Changes to the products, to the information contained in this document, and to prices are reserved, so are errors and omissions. Only order confirmations and technical documentation by Eaton is binding. Photos and pictures also do not warrant a specific layout or functionality. Their use in whatever form is subject to prior approval by Eaton. The same applies to Trademarks (especially Eaton, Moeller, Cutler-Hammer, Cooper, Bussmann). The Terms and Conditions of Eaton apply, as referenced on Eaton internet pages and Eaton order confirmations.

Eaton Industries GmbH
Hein-Moeller-Str. 7-11
D-53115 Bonn/Germany

© 2016 by Eaton Corporation
All rights reserved
Printed in Germany 11/16
Publication No.: CA047003EN
Version 1.0 / 1p November 2016
Article No.: 188298



Scan and use
the flip catalog