



## Circuit-breakers, fuses

Tested quality, approvals and shipping classifications represent the functionality and safety suitable for world markets with industrial miniature circuit-breakers. Besides a comprehensive range of residual current devices, LV h.b.c. fuse bases and fuse switch-disconnectors is provided.

### **FAZ miniature circuit-breakers**

Height 80 mm only +++ Installation and removal without disassembly of the rails +++ Double comfort terminal lift/claw +++ Terminal with rear plug protection → Page 19/4

### **Digital residual current device**

Preventive information +++ Warning before tripping +++ Integrated auxiliary contact +++ Display for earth-fault release → Page 19/21

### **Fuse base**

Integrated terminal covers +++ Double terminals → Page 19/42

### **Cylindrical fuse switch-disconnectors**

With flash function on tripped fuse +++ can be sealed → Page 19/45

### **Fuse switch-disconnectors (empty) C10-FD**

Cord protection for photovoltaic generator +++ Trip indicator signals tripped fuse link: 50 – 400 V: blinking, 400 – 1000 V: continuous light +++ Nominal current voltage 1000 V DC +++ For cylindrical fuse inserts in photovoltaic applications +++ Sealable → Page 19/48

## Circuit-breaker

### System overview

Miniature circuit-breakers, residual current devices	19/2
--	------

### Ordering

Miniature circuit-breakers	19/4
FAZ	19/4
FAZT	19/10
FAZ-PN	19/12
FAZ for DC applications	19/13
AZ	19/14
Residual current device, leakage current meter	19/16
PKNM combination switches, power meters	19/17
mRB6, mRB4 combination switches	19/18
Residual current device	
FI	19/19
dRCM	19/21
Remote monitoring unit	19/22
Remote switching modules, remote test modules	19/22
FI residual current devices only for export	19/23
Auxiliary contacts and shunt releases	19/24
LS auxiliary contacts	19/24
Trip-indicating auxiliary contacts/auxiliary contacts	19/24
FI auxiliary contacts, shunt releases	19/24
Undervoltage releases, MCB lock	19/24
Mounting accessories	19/25
EVG busbar	19/25
Phase busbars accessory, extension terminals	19/27
Busbar tag shroud	19/27
ZV-SS busbars, shroud section	19/27
Miniature circuit-breakers for North America	19/28
FAZ-...-NA	19/28
FAZ-...-RT	19/34
Accessories for miniature circuit-breakers North America	19/40

### Engineering

FAZ... miniature circuit-breakers	19/54
Tripping characteristic	19/56
Let-through characteristics	19/59

### Technical data

Miniature circuit-breakers	19/65
Residual current device	19/66
Auxiliary contacts, shunt releases	19/70

### Dimensions

Miniature circuit-breakers	19/82
Residual current device	19/82
Auxiliary contacts	19/84

## Fuses

### Ordering

Fuse bases	19/42
Fuse bases	19/42
Fuse bases 1 and 3 pole	19/42
Accessories for fuse bases	19/43
Covers	19/43
Transparent shroud	19/43
Busbar connector, end cap	19/43
Notched phase busbars, can be cut to desired length	19/43
K35-AB connection terminal	19/43
Fuse inserts Z-DII(III)/SE	19/43
Gauge screw Z-DII(III)/PS	19/44
Ring inserts Z-DII(III)/PE	19/44
Screw cap Z-DII(III)/SK	19/44
Fuse switch-disconnector Z-SLS, empty	19/45
Fuse sets	19/45
Switch-on inhibits	19/46
Incoming double terminal	19/46
Fuse inserts Z-D01(02)/SE	19/47
Gauge rings Z-D01(02)/PE	19/47
Screw cap Z-D01(02)/SK	19/47
Spring Z-D02/SIKA-HF	19/47
Fuse switch-disconnectors, empty, photovoltaics	19/48
Fuse links, photovoltaics	19/48
Fuse switch-disconnector VLC, empty	19/49
Cylindrical fuse inserts Z-C19/50	
LV h.b.c. fuse bases	19/51
LV h.b.c. fuse switch-disconnectors	19/51
Set of connecting links	19/51
Cover with fuse monitoring	19/51
Busbar tag shroud	19/52
Clip set	19/52
Sets of clamp-type terminals	19/52
Insulating surround	19/52
LV h.b.c.-Fuse-links Z-NH...	19/53

### Engineering

Let-through characteristics	19/64
-----------------------------	-------

### Technical data

Fuse material	19/75
Fuse switch-disconnector	19/78
LV h.b.c. fuse switch-disconnectors	19/80
LV h.b.c. fuse base	19/81

### Dimensions

Fuse base	19/86
Fuse switch-disconnector	19/86
Fuse Bases	19/87

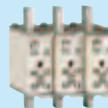
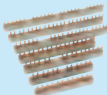

System overview

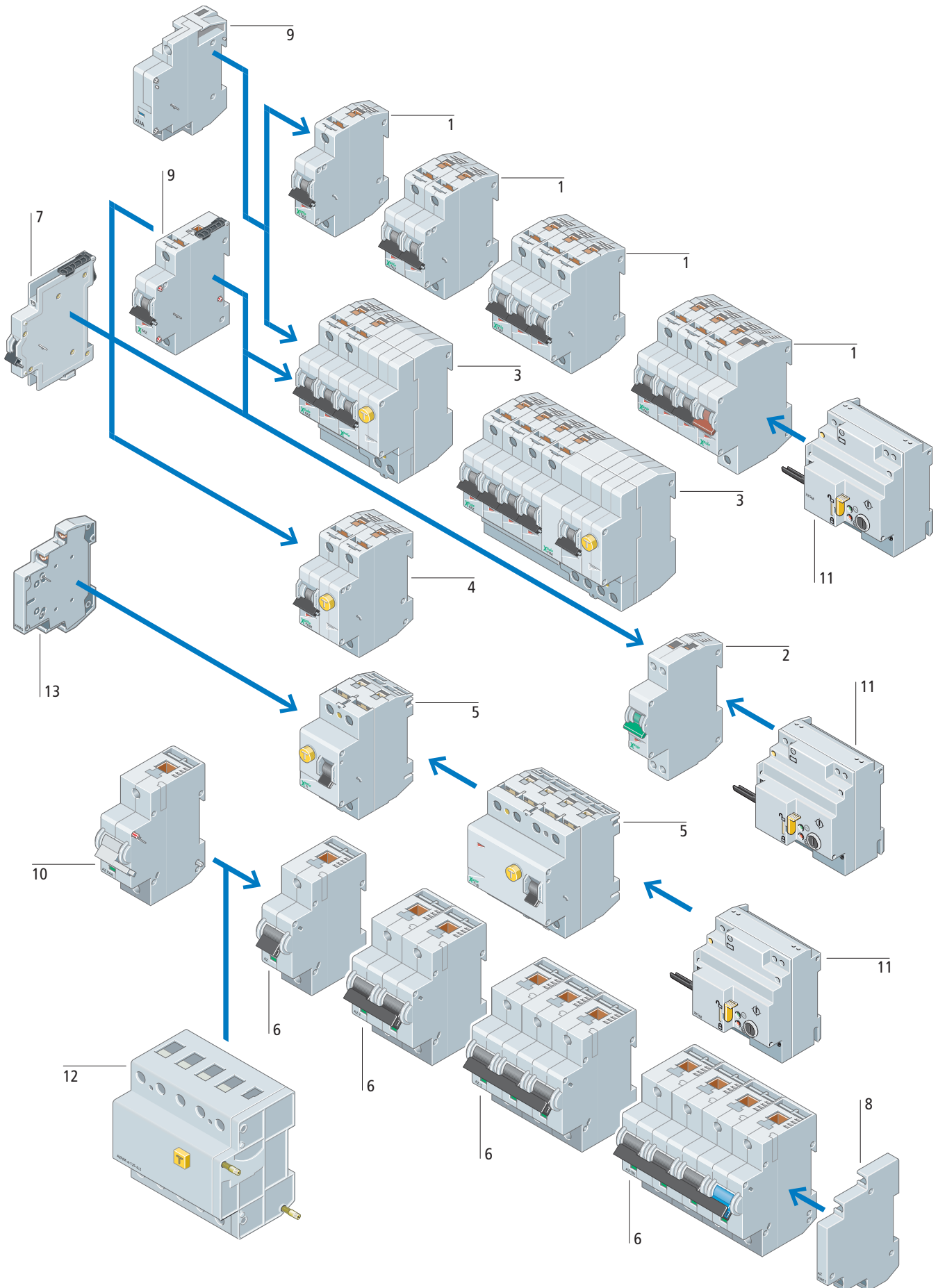

WWW.TM2A.PT info@tm2a.pt

WWW.TM2A.PT info@tm2a.pt



## Basic devices

<b>FAZ miniature circuit-breakers</b>	1
Characteristic/rated operational current ranges B/4 – 63 A; C/0.5 – 63 A; D/6 – 40 A; K/0.5 – 63 A; S/1 – 40 A; Z/0.5 – 63 A	
Switching capacity: 15 kA to IEC/EN 60947-2	
B, C, D, K, S, Z characteristic	
1-, 1N-, 2-, 3-, 3N-, 4 pole	
Special miniature circuit-breaker for control circuits (1, 2 pole)	
Special miniature circuit-breaker for DC applications up to 500 V DC	
→ Page 19/4	
<b>FAZT miniature circuit-breakers</b>	1
Characteristic/rated operational current ranges B/1 – 25 A; C/1 – 25 A; D/1 – 16 A	
Switching capacity: 25 kA to IEC/EN 60947-2	
→ Page 19/10	
<b>FAZ-PN miniature circuit-breaker</b>	2
Characteristic/rated operational current ranges B/6 – 40 A; C/2 – 40 A	
Switching capacity: 6 kA to IEC/EN 60898	
B, C characteristic	
1 N pole	
→ Page 19/12	
<b>Residual-current protective modules for fitting to FAZ</b>	3
Protection in the event of fault current	
Rated current ranges 40 – 63 A	
Rated fault current 30 mA, 300 mA	
→ Page 19/16	
<b>Residual-current protective modules for fitting to AZ</b>	12
Protection in the event of fault current	
Rated current ranges 80 – 125 A	
Rated fault current 30 mA, 300 mA	
→ Page 19/16	
<b>PKNM combined device</b>	4
Overload and short-circuit protection, and protection in the event of fault currents	
Characteristic/rated operational current ranges B/6-40 A; C/6-40 A; 1N pole	
Switching capacity: 10 kA to IEC/EN 60898	
Rated fault current 30 mA, 300 mA	
→ Page 19/17	

<b>Residual-current circuit-breaker (RCCB)</b>	5
AC current sensitive	
2 pole, 16 – 80 A	
4 pole, 25 – 80 A	
Pulsed current sensitive	
2 pole, 16 – 40 A	
4 pole, 25 – 125 A	
AC/DC sensitive	
4 pole, 40 – 125 A	
Rated fault current	
30 mA, 100 mA, 300 mA, 500 mA	
4 pole, selective, 63 – 80 A	
Rated fault current	
100 mA, 300 mA	
4 pole suitable for frequency inverters 40, 63 A, 100 mA, 300 mA	
→ Page 19/13	
<b>AZ miniature circuit-breakers</b>	6
Characteristic/rated operational current ranges C/20-125 A; D/50-100 A	
Switching capacity: 15 – 25 kA to IEC/EN 60947-2, 1-, 2-, 3-, 3N-, 4 pole	
→ Page 19/14	

## Add-on functions

<b>FAZ auxiliary contact</b>	7
Standard auxiliary contact	
Trip-indicating auxiliary contacts	
Auxiliary contacts	
→ Page 19/24	
<b>AZ auxiliary contact</b>	8
Standard auxiliary contacts	
→ Page 19/24	
<b>FAZ shunt releases</b>	9
Undervoltage release	
Shunt releases	
Can be fitted to FAZ or FAZ-FIM	
→ Page 19/24	
<b>AZ shunt releases</b>	10
Shunt releases	
→ Page 19/24	
<b>FI auxiliary contact</b>	13
Auxiliary contacts	
→ Page 19/24	
<b>Remote switching module</b>	11
Suitable for remote switching and automatic restart of a miniature circuit-breaker or RCCB, for remote trip testing of an RCCB in conjunction with a remote test module	
→ Page 19/22	



Ordering

	1 pole			2 pole With 2 protected poles			3 pole With 3 protected poles			
	Rated operational current $I_n$ A	Part no. Article no.	Price See price list	Std. pack	Part no. Article no.	Price See price list	Std. pack	Part no. Article no.	Price See price list	Std. pack
<b>FAZ miniature circuit-breakers</b>										
Characteristic B	4	FAZ-B4/1-HS 279274		12 off	FAZ-B4/2-HS 279275		1 off			
Instantaneous release	5	FAZ-B5/1 278528		12 off						
response current 3 - 5 x $I_n$	6	FAZ-B6/1 278529			FAZ-B6/2 278728		1 off	FAZ-B6/3 278841		1 off
Switching capacity 15 kA (IEC/EN 60947-2)	8	FAZ-B8/1 278530			FAZ-B8/2 278729			FAZ-B8/3 278842		
	10	FAZ-B10/1 278531			FAZ-B10/2 278730			FAZ-B10/3 278843		
	12	FAZ-B12/1 278532			FAZ-B12/2 278731			FAZ-B12/3 278844		
	13	FAZ-B13/1 278533			FAZ-B13/2 278732			FAZ-B13/3 278845		
	15	FAZ-B15/1 278534			FAZ-B15/2 278733			FAZ-B15/3 278846		
	16	FAZ-B16/1 278535			FAZ-B16/2 278734			FAZ-B16/3 278847		
	20	FAZ-B20/1 278536			FAZ-B20/2 278735			FAZ-B20/3 278848		
	25	FAZ-B25/1 278537			FAZ-B25/2 278736			FAZ-B25/3 278849		
	32	FAZ-B32/1 278538			FAZ-B32/2 278737			FAZ-B32/3 278850		
	40	FAZ-B40/1 278539			FAZ-B40/2 278738			FAZ-B40/3 278851		
	50	FAZ-B50/1 278540			FAZ-B50/2 278739			FAZ-B50/3 278852		
	63	FAZ-B63/1 278541			FAZ-B63/2 278740			FAZ-B63/3 278853		
<b>Characteristic C</b>										
Instantaneous release	0.5	FAZ-C0.5/1 278544		12 off	FAZ-C0.5/2 278743		1 off	FAZ-C0.5/3 278856		1 off
response current 5 - 10 x $I_n$	1	FAZ-C1/1 278546			FAZ-C1/2 278745			FAZ-C1/3 278858		
Switching capacity 15 kA (IEC/EN 60947-2)	1.6	FAZ-C0.5/1 278548			FAZ-C1.6/2 278747			FAZ-C1.6/3 278860		
	2	FAZ-C2/1 278549			FAZ-C2/2 278748			FAZ-C2/3 278861		
	3	FAZ-C3/1 278551			FAZ-C3/2 278750			FAZ-C3/3 278863		
	4	FAZ-C4/1 278553			FAZ-C4/2 278752			FAZ-C4/3 278865		
	6	FAZ-C6/1 278555			FAZ-C6/2 278754			FAZ-C6/3 278867		
	8	FAZ-C8/1 278556			FAZ-C8/2 278755			FAZ-C8/3 278868		
	10	FAZ-C10/1 278557			FAZ-C10/2 278756			FAZ-C10/3 278869		
	13	FAZ-C13/1 278559			FAZ-C13/2 278758			FAZ-C13/3 278871		
	16	FAZ-C16/1 278561			FAZ-C16/2 278760			FAZ-C16/3 278873		
	20	FAZ-C20/1 278562			FAZ-C20/2 278761			FAZ-C20/3 278874		
	25	FAZ-C25/1 278563			FAZ-C25/2 278762			FAZ-C25/3 278875		
	32	FAZ-C32/1 278564			FAZ-C32/2 278763			FAZ-C32/3 278876		
	40	FAZ-C40/1 278565			FAZ-C40/2 278764			FAZ-C40/3 278877		
	50	FAZ-C50/1 278566			FAZ-C50/2 278765			FAZ-C50/3 278878		
	63	FAZ-C63/1 278567			FAZ-C63/2 278766			FAZ-C63/3 278879		

	4 pole With 4 protected poles			2 pole With 1 protected pole, N switching with pole			4 pole With 3 protected poles, N switching with poles			Notes
	Part no. Article no.	Price See price list	Std. pack	Part no. Article no.	Price See price list	Std. pack	Part no. Article no.	Price See price list	Std. pack	
	FAZ-B6/4 279029		1 off	FAZ-B6/1N 278642		1 off	FAZ-B6/3N 278943		1 off	<p>Switching capacity (IEC/EN 60898) 10 kA</p> <p>Switching capacity (IEC/EN 60947-2) 15 kA</p> <p><b>Accessories Page</b></p> <p>Auxiliary contacts → 19/24</p> <p>Shunt releases</p> <p>Mounting accessories → 19/25</p> <p>FAZ-B4/1-HS, FAZ-B4/2-HS Special miniature circuit-breakers with much reduced let-through energy to prevent contact weld of <b>auxiliary contacts</b></p> <p>1 pole Depth 71 mm Width 17.5 mm</p> <p>2 pole; 1 pole + N Depth 71 mm Width 35 mm</p> <p>3 pole Depth 71 mm Width 52.5 mm</p> <p>4 pole; 3 pole + N Depth 71 mm Width 70 mm</p> <p><b>Information relevant for export to North America</b></p> <p>Product Standards IEC/EN 60947-2; IEC/EN 60898; UL 1077; CSA-C22.2 No. 235; CE marking E177451</p> <p>UL File No. QVNU2, QVNU8</p> <p>UL CCN 204453</p> <p>CSA File No. 3215-30</p> <p>CSA Class No. 3215-30</p> <p>UL Certification UL Recognized, CSA certified</p> <p>Conditions of Acceptability Supplementary Protector only</p> <p>Suitable for Branch Circuits; not as BCPD</p> <p>Max. Voltage Rating 1 pole: 277 V AC; 48 V DC 2 pole: 480 Y/277 V AC; 96 V DC 3 pole: 480 Y/277 V AC</p> <p>Degree of Protection IEC: IP20; UL/CSA Type: -</p> <p>Short Circuit Current Rating ≤ 40 A 10 kA ≥ 50 A 5 kA</p>
	FAZ-B8/4 279030			FAZ-B8/1N 278643			FAZ-B8/3N 278944			
	FAZ-B10/4 279031			FAZ-B10/1N 278644			FAZ-B10/3N 278945			
	FAZ-B12/4 279032			FAZ-B12/1N 278645			FAZ-B12/3N 278946			
	FAZ-B13/4 279033			FAZ-B13/1N 278646			FAZ-B13/3N 278947			
	FAZ-B15/4 279034			FAZ-B15/1N 278647			FAZ-B15/3N 278948			
	FAZ-B16/4 279035			FAZ-B16/1N 278648			FAZ-B16/3N 278949			
	FAZ-B20/4 279036			FAZ-B20/1N 278649			FAZ-B20/3N 278950			
	FAZ-B25/4 279037			FAZ-B25/1N 278650			FAZ-B25/3N 278951			
	FAZ-B32/4 279038			FAZ-B32/1N 278651			FAZ-B32/3N 278952			
	FAZ-B40/4 279039			FAZ-B40/1N 278652			FAZ-B40/3N 278953			
	FAZ-B50/4 279040			FAZ-B50/1N 278653			FAZ-B50/3N 278954			
	FAZ-B63/4 279041			FAZ-B63/1N 278654			FAZ-B63/3N 278955			
	FAZ-C0.5/4 279044		1 off	FAZ-C0.5/1N 278657		1 off	FAZ-C0.5/3N 278958		1 off	
	FAZ-C1/4 279046			FAZ-C1/1N 278659			FAZ-C1/3N 278960			
	FAZ-C1.6/4 279048			FAZ-C1.6/1N 278661			FAZ-C1.6/3N 278962			
	FAZ-C2/4 279049			FAZ-C2/1N 278662			FAZ-C2/3N 278963			
	FAZ-C3/4 279051			FAZ-C3/1N 278664			FAZ-C3/3N 278965			
	FAZ-C4/4 279053			FAZ-C4/1N 278666			FAZ-C4/3N 278967			
	FAZ-C6/4 279055			FAZ-C6/1N 278668			FAZ-C6/3N 278969			
	FAZ-C8/4 279056			FAZ-C8/1N 278669			FAZ-C8/3N 278970			
	FAZ-C10/4 279057			FAZ-C10/1N 278670			FAZ-C10/3N 278971			
	FAZ-C13/4 279059			FAZ-C13/1N 278672			FAZ-C13/3N 278973			
	FAZ-C16/4 279061			FAZ-C16/1N 278674			FAZ-C16/3N 278975			
	FAZ-C20/4 279062			FAZ-C20/1N 278675			FAZ-C20/3N 278976			
	FAZ-C25/4 279063			FAZ-C25/1N 278676			FAZ-C25/3N 278977			
	FAZ-C32/4 279064			FAZ-C32/1N 278677			FAZ-C32/3N 278978			
	FAZ-C40/4 279065			FAZ-C40/1N 278678			FAZ-C40/3N 278979			
	FAZ-C50/4 279066			FAZ-C50/1N 278679			FAZ-C50/3N 278980			
	FAZ-C63/4 279067			FAZ-C63/1N 278680			FAZ-C63/3N 278981			

WWW.TM2A.PT info@tm2a.pt

WWW.TM2A.PT info@tm2a.pt

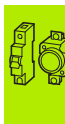
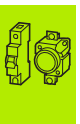



Rated operational current $I_n$ A	1 pole			2 pole With 2 protected poles			3 pole With 3 protected poles		
	Part no. Article no.	Price See price list	Std. pack	Part no. Article no.	Price See price list	Std. pack	Part no. Article no.	Price See price list	Std. pack
<b>FAZ miniature circuit-breakers</b>									
Characteristic D Instantaneous release response current 10 - 20 x $I_n$ Switching capacity 15 kA (IEC/EN 60947-2)	6	FAZ-D6/1 278578	12 off	FAZ-D6/2 278777		1 off	FAZ-D6/3 278890		1 off
	8	FAZ-D8/1 278579		FAZ-D8/2 278778			FAZ-D8/3 278891		
	10	FAZ-D10/1 278580		FAZ-D10/2 278779			FAZ-D10/3 278892		
	13	FAZ-D13/1 278582		FAZ-D13/2 278781			FAZ-D13/3 278894		
	16	FAZ-D16/1 278584		FAZ-D16/2 278783			FAZ-D16/3 278896		
	20	FAZ-D20/1 278585		FAZ-D20/2 278784			FAZ-D20/3 278897		
	25	FAZ-D25/1 278586		FAZ-D25/2 278785			FAZ-D25/3 278898		
	32	FAZ-D32/1 278587		FAZ-D32/2 278786			FAZ-D32/3 278899		
	40	FAZ-D40/1 278588		FAZ-D40/2 278787			FAZ-D40/3 279000		
Characteristic K Instantaneous release response current 8 - 12 x $I_n$ Switching capacity 15 kA (IEC/EN 60947-2)	0.5	FAZ-K0.5/1 278589	12 off	FAZ-K0.5/2 278788		1 off	FAZ-K0.5/3 278901		1 off
	1	FAZ-K1/1 278590		FAZ-K1/2 278789			FAZ-K1/3 278902		
	1.6	FAZ-K0.5/1 278591		FAZ-K1.6/2 278790			FAZ-K1.6/3 278903		
	2	FAZ-K2/1 278592		FAZ-K2/2 278791			FAZ-K2/3 278904		
	3	FAZ-K3/1 278593		FAZ-K3/2 278792			FAZ-K3/3 278905		
	4	FAZ-K4/1 278594		FAZ-K4/2 278793			FAZ-K4/3 278906		
	6	FAZ-K6/1 278595		FAZ-K6/2 278794			FAZ-K6/3 278907		
	8	FAZ-K8/1 278596		FAZ-K8/2 278795			FAZ-K8/3 278908		
	10	FAZ-K10/1 278597		FAZ-K10/2 278796			FAZ-K10/3 278909		
	13	FAZ-K13/1 278598		FAZ-K13/2 278797			FAZ-K13/3 278910		
	16	FAZ-K16/1 278599		FAZ-K16/2 278798			FAZ-K16/3 278911		
	20	FAZ-K20/1 278600		FAZ-K20/2 278799			FAZ-K20/3 278912		
	25	FAZ-K25/1 278601		FAZ-K25/2 278800			FAZ-K25/3 278913		
	32	FAZ-K32/1 278602		FAZ-K32/2 278801			FAZ-K32/3 278914		
	40	FAZ-K40/1 278603		FAZ-K40/2 278803			FAZ-K40/3 278916		
	50	FAZ-K50/1 278604		FAZ-K50/2 278803			FAZ-K50/3 278916		
	63	FAZ-K63/1 278605		FAZ-K63/2 278804			FAZ-K63/3 278917		

Rated operational current $I_n$ A	4 pole With 4 protected poles			4 pole With 3 protected poles, N switching with poles			Notes
	Part no. Article no.	Price See price list	Std. pack	Part no. Article no.	Price See price list	Std. pack	
<b>FAZ miniature circuit-breakers</b>							
	FAZ-D6/4 279078		1 off	FAZ-D6/3N 278992		1 off	<p>Switching capacity (IEC/EN 60898) 10 kA</p> <p>Switching capacity (IEC/EN 60947-2) 15 kA</p> <p><b>Accessories</b> Auxiliary contacts → 19/24 Shunt releases Mounting accessories → 19/25</p> <p><b>Page</b></p> <p>1 pole Depth 71 mm Width 17.5 mm</p> <p>2 pole; 1 pole + N Depth 71 mm Width 35 mm</p> <p>3 pole Depth 71 mm Width 52.5 mm</p> <p>4 pole; 3 pole + N Depth 71 mm Width 70 mm</p> <p><b>Information relevant for export to North America</b></p> <p>Product Standards IEC/EN 60947-2; IEC/EN 60898; UL 1077; CSA-C22.2 No. 235; CE marking</p> <p>UL File No. E177451 UL CCN QVNU2, QVNU8</p> <p>CSA File No. 204453 CSA Class No. 3215-30</p> <p>NA Certification UL Recognized, CSA certified</p> <p>Conditions of Acceptability Supplementary Protector only</p> <p>Suitable for Branch Circuits; not as BCPD</p> <p>Max. Voltage Rating 1 pole: 277 V AC; 48 V DC 2 pole: 480 Y/277 V AC; 96 V DC 3 pole: 480 Y/277 V AC</p> <p>Degree of Protection IEC: IP20; UL/CSA Type: -</p> <p>Short Circuit Current Rating ≤ 40 A 10 kA ≥ 50 A 5 kA</p>
	FAZ-D8/4 279079			FAZ-D8/3N 278993			
	FAZ-D10/4 279080			FAZ-D10/3N 278994			
	FAZ-D13/4 279082			FAZ-D13/3N 278996			
	FAZ-D16/4 279084			FAZ-D16/3N 278998			
	FAZ-D20/4 279085			FAZ-D20/3N 278999			
	FAZ-D25/4 279086			FAZ-D25/3N 29000			
	FAZ-D32/4 279087			FAZ-D32/3N 279001			
	FAZ-D40/4 279088			FAZ-D40/3N 279002			
	FAZ-K0.5/4 279089		1 off	FAZ-K0.5/3N 279003		1 off	
	FAZ-K1/4 279090			FAZ-K1/3N 279004			
	FAZ-K1.6/4 279091			FAZ-K1.6/3N 279005			
	FAZ-K2/4 279092			FAZ-K2/3N 279006			
	FAZ-K3/4 279093			FAZ-K3/3N 279007			
	FAZ-K4/4 279094			FAZ-K4/3N 279008			
	FAZ-K6/4 279095			FAZ-K6/3N 279009			
	FAZ-K8/4 279096			FAZ-K8/3N 279010			
	FAZ-K10/4 279097			FAZ-K10/3N 279011			
	FAZ-K13/4 279098			FAZ-K13/3N 279012			
	FAZ-K16/4 279099			FAZ-K16/3N 279013			
	FAZ-K20/4 279100			FAZ-K20/3N 279014			
	FAZ-K25/4 279101			FAZ-K25/3N 279015			
	FAZ-K32/4 279102			FAZ-K32/3N 279016			
	FAZ-K40/4 279103			FAZ-K40/3N 279017			
	FAZ-K50/4 279104			FAZ-K50/3N 279018			
	FAZ-K63/4 279105			FAZ-K63/3N 279019			

WWW.TM2A.PT info@tm2a.pt

WWW.TM2A.PT info@tm2a.pt



	Rated current $I_n$ A	1 pole		Std. pack	2 pole		Std. pack
		Part no. Article no.	Price See price list		Part no. Article no.	Price See price list	
<b>FAZ miniature circuit-breakers</b>							
Characteristic S Instantaneous release response current 13 - 17 x $I_n$ Switching capacity 10 kA (IEC/EN 60947-2)	1	FAZ-S1/1 278606		12 off 	FAZ-S1/2 278805		1 off 
	2	FAZ-S2/1 278607			FAZ-S2/2 278806		
	3	FAZ-S3/1 278608			FAZ-S3/2 278807		
	4	FAZ-S4/1 278609			FAZ-S4/2 278808		
	6	FAZ-S6/1 278610			FAZ-S6/2 278809		
	10	FAZ-S10/1 278611			FAZ-S10/2 278810		
	16	FAZ-S16/1 278612			FAZ-S16/2 278811		
	20	FAZ-S20/1 278613			FAZ-S20/2 278812		
	25	FAZ-S25/1 278614			FAZ-S25/2 278813		
	32	FAZ-S32/1 278615			FAZ-S32/2 278814		
40	FAZ-S40/1 278616		FAZ-S40/2 278815				
Characteristic Z Instantaneous release response current 2 - 3 x $I_n$ Switching capacity 10 kA (IEC/EN 60947-2)	0.5	FAZ-Z0.5/1 278617		12 off 	FAZ-Z0.5/2 278816		1 off 
	1	FAZ-Z1/1 278618			FAZ-Z1/2 278817		
	1.6	FAZ-Z1.6/1 278619			FAZ-Z1.6/2 278818		
	2	FAZ-Z2/1 278620			FAZ-Z2/2 278819		
	3	FAZ-Z3/1 278621			FAZ-Z3/2 278820		
	4	FAZ-Z4/1 278622			FAZ-Z4/2 278821		
	6	FAZ-Z6/1 278623			FAZ-Z6/2 278822		
	8	FAZ-Z8/1 278624			FAZ-Z8/2 278823		
	10	FAZ-Z10/1 278625			FAZ-Z10/2 278824		
	16	FAZ-Z16/1 278626			FAZ-Z16/2 278825		
	20	FAZ-Z20/1 278627			FAZ-Z20/2 278826		
	25	FAZ-Z25/1 278628			FAZ-Z25/2 278827		
	32	FAZ-Z32/1 278629			FAZ-Z32/2 278828		
	40	FAZ-Z40/1 278630			FAZ-Z40/2 278829		
	50	FAZ-Z50/1 278631			FAZ-Z50/2 278830		
	63	FAZ-Z63/1 278632			FAZ-Z63/2 278831		

	Rated current $I_n$ A	3 pole		Std. pack	4 pole		Std. pack	Notes
		Part no. Article no.	Price See price list		Part no. Article no.	Price See price list		
<b>FAZ miniature circuit-breakers</b>								
Characteristic S Instantaneous release response current 13 - 17 x $I_n$ Switching capacity 10 kA (IEC/EN 60947-2)	1	FAZ-S1/1 278606		12 off 	FAZ-S1/2 278805		1 off 	Switching capacity (IEC/EN 60898) 10 kA Switching capacity (IEC/EN 60947-2) 15 kA  <b>Accessories</b> <b>Page</b> Auxiliary contacts → 19/24 Shunt releases Mounting accessories → 19/25  1 pole      2 pole; 1 pole + N Depth 71 mm      Depth 71 mm Width 17.5 mm      Width 35 mm   3 pole      4 pole; 3 pole + N Depth 71 mm      Depth 71 mm Width 52.5 mm      Width 70 mm
	2	FAZ-S2/1 278607			FAZ-S2/2 278806			
	3	FAZ-S3/1 278608			FAZ-S3/2 278807			
	4	FAZ-S4/1 278609			FAZ-S4/2 278808			
	6	FAZ-S6/1 278610			FAZ-S6/2 278809			
	10	FAZ-S10/1 278611			FAZ-S10/2 278810			
	16	FAZ-S16/1 278612			FAZ-S16/2 278811			
	20	FAZ-S20/1 278613			FAZ-S20/2 278812			
	25	FAZ-S25/1 278614			FAZ-S25/2 278813			
	32	FAZ-S32/1 278615			FAZ-S32/2 278814			
40	FAZ-S40/1 278616		FAZ-S40/2 278815					
Characteristic Z Instantaneous release response current 2 - 3 x $I_n$ Switching capacity 10 kA (IEC/EN 60947-2)	0.5	FAZ-Z0.5/1 278617		12 off 	FAZ-Z0.5/2 278816		1 off 	
	1	FAZ-Z1/1 278618			FAZ-Z1/2 278817			
	1.6	FAZ-Z1.6/1 278619			FAZ-Z1.6/2 278818			
	2	FAZ-Z2/1 278620			FAZ-Z2/2 278819			
	3	FAZ-Z3/1 278621			FAZ-Z3/2 278820			
	4	FAZ-Z4/1 278622			FAZ-Z4/2 278821			
	6	FAZ-Z6/1 278623			FAZ-Z6/2 278822			
	8	FAZ-Z8/1 278624			FAZ-Z8/2 278823			
	10	FAZ-Z10/1 278625			FAZ-Z10/2 278824			
	16	FAZ-Z16/1 278626			FAZ-Z16/2 278825			
	20	FAZ-Z20/1 278627			FAZ-Z20/2 278826			
	25	FAZ-Z25/1 278628			FAZ-Z25/2 278827			
	32	FAZ-Z32/1 278629			FAZ-Z32/2 278828			
	40	FAZ-Z40/1 278630			FAZ-Z40/2 278829			
	50	FAZ-Z50/1 278631			FAZ-Z50/2 278830			
	63	FAZ-Z63/1 278632			FAZ-Z63/2 278831			

Switching capacity (IEC/EN 60898) 10 kA  
Switching capacity (IEC/EN 60947-2) 15 kA

**Accessories**      **Page**  
Auxiliary contacts → 19/24  
Shunt releases  
Mounting accessories → 19/25

1 pole      2 pole; 1 pole + N  
Depth 71 mm      Depth 71 mm  
Width 17.5 mm      Width 35 mm



3 pole  
Depth 71 mm  
Width 52.5 mm



4 pole; 3 pole + N  
Depth 71 mm  
Width 70 mm

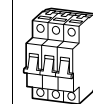

3 pole  
Depth 71 mm  
Width 52.5 mm

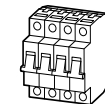

4 pole; 3 pole + N  
Depth 71 mm  
Width 70 mm

**Information relevant for export to North America**

Product Standards IEC/EN 60947-2; IEC/EN 60898; UL 1077; CSA-C22.2 No. 235; CE marking

UL File No. E177451  
UL CCN QVNU2, QVNU8  
CSA File No. 204453  
CSA Class No. 3215-30  
NA Certification UL Recognized, CSA certified



Conditions of Acceptability Supplementary Protector only

Suitable for Branch Circuits; not as BCPD  
Max. Voltage Rating 1 pole: 277 V AC; 48 V DC  
2 pole: 480 Y/277 V AC; 96 V DC  
3 pole: 480 Y/277 V AC

Degree of Protection IEC: IP20; UL/CSA Type: -

Short Circuit Current Rating  
≤ 40 A 10 kA  
≥ 50 A 5 kA

Rated operational current I <sub>n</sub> A	1 pole			1 pole+N			2 pole			
	Part no. Article no.	Price See price list	Std. pack	Part no. Article no.	Price See price list	Std. pack	Part no. Article no.	Price See price list	Std. pack	
<b>FAZT miniature circuit-breakers</b>										
Characteristic B Switching capacity 25 kA (IEC/EN 60947-2)	1	FAZT-B1/1 240770	12 off	FAZT-B1/1N 240994	1 off	FAZT-B1/2 240820	1 off			
	2	FAZT-B2/1 240771		FAZT-B2/1N 240995		FAZT-B2/2 240821				
	3	FAZT-B3/1 240772		FAZT-B3/1N 240996		FAZT-B3/2 240822				
	4	FAZT-B4/1 240777		FAZT-B4/1N 240997		FAZT-B4/2 240823				
	6	FAZT-B6/1 240782		FAZT-B6/1N 240998		FAZT-B6/2 240824				
	10	FAZT-B10/1 240787		FAZT-B10/1N 240999		FAZT-B10/2 240825				
	12	FAZT-B12/1 240792		FAZT-B12/1N 241000		FAZT-B12/2 240826				
	13	FAZT-B13/1 240793		FAZT-B13/1N 241001		FAZT-B13/2 240827				
	15	FAZT-B15/1 240794		FAZT-B15/1N 241005		FAZT-B15/2 240828				
	16	FAZT-B16/1 240795		FAZT-B16/1N 241009		FAZT-B16/2 240829				
	20	FAZT-B20/1 240796		FAZT-B20/1N 241015		FAZT-B20/2 240830				
	25	FAZT-B25/1 240797		FAZT-B25/1N 241019		FAZT-B25/2 240831				
	32 <sup>1)</sup>	FAZT-B32/1 141907		FAZT-B32/1N 142509		FAZT-B32/2 142485				
	40 <sup>1)</sup>	FAZT-B40/1 141908		FAZT-B40/1N 142510		FAZT-B40/2 142486				
	Characteristic C Switching capacity 25 kA (IEC/EN 60947-2)	1	FAZT-C1/1 240798	12 off	FAZT-C1/1N 241022	1 off	FAZT-C1/2 240832	1 off		
		2	FAZT-C2/1 240799		FAZT-C2/1N 241023		FAZT-C2/2 240833			
3		FAZT-C3/1 240800		FAZT-C3/1N 241024		FAZT-C3/2 240838				
4		FAZT-C4/1 240801		FAZT-C4/1N 241025		FAZT-C4/2 240843				
6		FAZT-C6/1 240802		FAZT-C6/1N 241026		FAZT-C6/2 240850				
10		FAZT-C10/1 240803		FAZT-C10/1N 241027		FAZT-C10/2 240855				
12		FAZT-C12/1 240804		FAZT-C12/1N 241028		FAZT-C12/2 240858				
13		FAZT-C13/1 240805		FAZT-C13/1N 241029		FAZT-C13/2 240859				
15		FAZT-C15/1 240806		FAZT-C15/1N 241030		FAZT-C15/2 240861				
16		FAZT-C16/1 240807		FAZT-C16/1N 241034		FAZT-C16/2 240862				
20		FAZT-C20/1 240808		FAZT-C20/1N 241038		FAZT-C20/2 240863				
25		FAZT-C25/1 240809		FAZT-C25/1N 241044		FAZT-C25/2 240863				
32 <sup>1)</sup>		FAZT-C32/1 141909		FAZT-C32/1N 142511		FAZT-C32/2 142487				
40 <sup>1)</sup>		FAZT-C40/1 142480		FAZT-C40/1N 142512		FAZT-C40/2 142488				
Characteristic D Switching capacity 25 kA (IEC/EN 60947-2)		1	FAZT-D1/1 240810	12 off	FAZT-D1/1N 241048	1 off	FAZT-D1/2 240864	1 off		
		2	FAZT-D2/1 240811		FAZT-D2/1N 241051		FAZT-D2/2 240865			
	3	FAZT-D3/1 240812		FAZT-D3/1N 241052		FAZT-D3/2 240866				
	4	FAZT-D4/1 240813		FAZT-D4/1N 241053		FAZT-D4/2 240867				
	6	FAZT-D6/1 240814		FAZT-D6/1N 241054		FAZT-D6/2 240868				

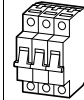
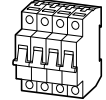
3 pole	3 pole+N			4 pole			Notes	
	Part no. Article no.	Price See price list	Std. pack	Part no. Article no.	Price See price list	Std. pack		Part no. Article no.
FAZT-B1/3 240874	FAZT-B1/3N 241060	1 off	FAZT-B1/4 240922	1 off			<p>Switching capacity (IEC/EN 60947-2) 25 kA</p> <p><b>Accessories</b>      <b>Page</b></p> <p>Auxiliary contacts → 19/24</p> <p>Shunt releases</p> <p>Mounting accessories → 19/25</p> <p>1 pole Depth 71 mm Width 17.5 mm</p>  <p>2 pole; 1 pole + N Depth 71 mm Width 35 mm</p>  <p>3 pole Depth 71 mm Width 52.5 mm</p>  <p>4 pole; 3 pole + N Depth 71 mm Width 70 mm</p>  <p><sup>1)</sup> For additional Technical Data and Characteristic Curves see "Installation Products for Industrial Application FAZ-T": <a href="http://www.moeller.net/cn/support/pdf_Katalog.jsp">www.moeller.net/cn/support/pdf_Katalog.jsp</a></p>	
FAZT-B2/3 240875	FAZT-B2/3N 241065		FAZT-B2/4 240927					
FAZT-B3/3 240876	FAZT-B3/3N 241070		FAZT-B3/4 240930					
FAZT-B4/3 240877	FAZT-B4/3N 241075		FAZT-B4/4 240931					
FAZT-B6/3 240878	FAZT-B6/3N 241080		FAZT-B6/4 240932					
FAZT-B10/3 240879	FAZT-B10/3N 241085		FAZT-B10/4 240933					
FAZT-B12/3 240880	FAZT-B12/3N 241090		FAZT-B12/4 240934					
FAZT-B13/3 240881	FAZT-B13/3N 241095		FAZT-B13/4 240935					
FAZT-B15/3 240882	FAZT-B15/3N 241100		FAZT-B15/4 240936					
FAZT-B16/3 240883	FAZT-B16/3N 241105		FAZT-B16/4 240937					
FAZT-B20/3 240884	FAZT-B20/3N 241110		FAZT-B20/4 240938					
FAZT-B25/3 240885	FAZT-B25/3N 241115		FAZT-B25/4 240939					
FAZT-B32/3 142493	FAZT-B32/3N 142517		FAZT-B32/4 142501					
FAZT-B40/3 142494	FAZT-B40/3N 142518		FAZT-B40/4 142502					
FAZT-C1/3 240886	FAZT-C1/3N 241120	1 off	FAZT-C1/4 240940	1 off				
FAZT-C2/3 240887	FAZT-C2/3N 241125		FAZT-C2/4 240941					
FAZT-C3/3 240888	FAZT-C3/3N 241130		FAZT-C3/4 240945					
FAZT-C4/3 240889	FAZT-C4/3N 241135		FAZT-C4/4 240949					
FAZT-C6/3 240890	FAZT-C6/3N 241140		FAZT-C6/4 240955					
FAZT-C10/3 240891	FAZT-C10/3N 241145		FAZT-C10/4 240959					
FAZT-C12/3 240892	FAZT-C12/3N 241150		FAZT-C12/4 240962					
FAZT-C13/3 240893	FAZT-C13/3N 241155		FAZT-C13/4 240963					
FAZT-C15/3 240894	FAZT-C15/3N 241160		FAZT-C15/4 240964					
FAZT-C16/3 240895	FAZT-C16/3N 241165		FAZT-C16/4 240965					
FAZT-C20/3 240896	FAZT-C20/3N 241170		FAZT-C20/4 240966					
FAZT-C25/3 240897	FAZT-C25/3N 241175		FAZT-C25/4 240967					
FAZT-C32/3 142495	FAZT-B32/3N 142519		FAZT-C32/4 142503					
FAZT-C40/3 142496	FAZT-B40/3N 142520		FAZT-C40/4 142504					
FAZT-D1/3 240898	FAZT-D1/3N 241180	1 off	FAZT-D1/4 240968	1 off				
FAZT-D2/3 240899	FAZT-D2/3N 241181		FAZT-D2/4 240969					
FAZT-D3/3 240900	FAZT-D3/3N 241182		FAZT-D3/4 240970					
FAZT-D4/3 240901	FAZT-D4/3N 241183		FAZT-D4/4 240971					
FAZT-D6/3 240902	FAZT-D6/3N 241184		FAZT-D6/4 240975					

WWW.TM2A.PT info@tm2a.pt

WWW.TM2A.PT info@tm2a.pt

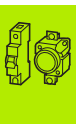

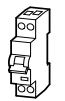

Rated operational current $I_n$ A	1 pole			1 pole+N			2 pole			
	Part no. Article no.	Price See price list	Std. pack	Part no. Article no.	Price See price list	Std. pack	Part no. Article no.	Price See price list	Std. pack	
<b>FAZT miniature circuit-breakers</b>										
Characteristic D Switching capacity 25 kA (IEC/EN 60947-2)	10	FAZT-D10/1 240815		12 off	FAZT-D10/1N 241055		1 off	FAZT-D10/2 240869		1 off
	12	FAZT-D12/1 240816			FAZT-D12/1N 241056			FAZT-D12/2 240870		
	13	FAZT-D13/1 240817			FAZT-D13/1N 241057			FAZT-D13/2 240871		
	15	FAZT-D15/1 240818			FAZT-D15/1N 241058			FAZT-D15/2 240872		
	16	FAZT-D16/1 240819			FAZT-D16/1N 241059			FAZT-D16/2 240873		
	20 <sup>1)</sup>	FAZT-D20/1 142481			FAZT-D20/1N 142513			FAZT-D20/2 142489		
	25 <sup>1)</sup>	FAZT-D25/1 142482			FAZT-D25/1N 142514			FAZT-D25/2 142490		
	32 <sup>1)</sup>	FAZT-D32/1 142483			FAZT-D32/1N 142515			FAZT-D32/2 142491		
40 <sup>1)</sup>	FAZT-D40/1 142484			FAZT-D40/1N 142516			FAZT-D40/2 142492			

Rated operational current $I_n$ A	2 pole			Std. pack	Notes
	Part no. Article no.	Price See price list	Notes		
<b>FAZ-PN miniature circuit-breaker</b>					
Characteristic B Instantaneous release response current 3 - 5 x $I_n$ Switching capacity 6 kA (IEC/EN 60898)	6	FAZ-PN-B6/1N 279146		12 off	<b>Accessories</b> <b>Page</b> Auxiliary contacts → 19/24 Shunt releases  1 N pole Depth 71 mm Width 17.5 mm 
	10	FAZ-PN-B10/1N 279147			
	13	FAZ-PN-B13/1N 279148			
	16	FAZ-PN-B16/1N 279149			
	20	FAZ-PN-B20/1N 279150			
	25	FAZ-PN-B25/1N 279151			
	32	FAZ-PN-B32/1N 279152			
	40	FAZ-PN-B40/1N 279153			
Characteristic C Instantaneous release response current 5 - 10 x $I_n$ Switching capacity 6 kA (IEC/EN 60898)	2	FAZ-PN-C2/1N 279154		12 off	
	4	FAZ-PN-C4/1N 279155			
	6	FAZ-PN-C6/1N 279156			
	10	FAZ-PN-C10/1N 279157			
	13	FAZ-PN-C13/1N 279158			
	16	FAZ-PN-C16/1N 279159			
	20	FAZ-PN-C20/1N 279160			
	25	FAZ-PN-C25/1N 279161			
32	FAZ-PN-C32/1N 279162				
40	FAZ-PN-C40/1N 279163				



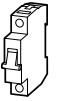
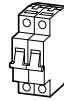

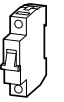
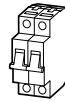
Rated operational current $I_n$ A	3 pole			3 pole+N			4 pole			Notes	
	Part no. Article no.	Price See price list	Std. pack	Part no. Article no.	Price See price list	Std. pack	Part no. Article no.	Price See price list	Std. pack		
<b>FAZT miniature circuit-breakers</b>											
Characteristic D Switching capacity 25 kA (IEC/EN 60947-2)	10	FAZT-D10/3 240903		1 off	FAZT-D10/3N 241185		1 off	FAZT-D10/4 240979		1 off	Switching capacity 25 kA (IEC/EN 60947-2)  <b>Accessories</b> <b>Page</b> Auxiliary contacts → 19/24 Shunt releases Mounting accessories → 19/25  1 pole Depth 71 mm Width 17.5 mm  2 pole; 1 pole + N Depth 71 mm Width 35 mm  3 pole Depth 71 mm Width 52.5 mm  4 pole; 3 pole + N Depth 71 mm Width 70 mm  → Graphics, Page 19/11  <sup>1)</sup> For additional Technical Data and Characteristic Curves see "Installation Products for Industrial Application FAZ-T": <a href="http://www.moeller.net/cn/support/pdf_Katalog.jsp">www.moeller.net/cn/support/pdf_Katalog.jsp</a>
	12	FAZT-D12/3 240904			FAZT-D12/3N 241186			FAZT-D12/4 240985			
	13	FAZT-D13/3 240905			FAZT-D13/3N 241187			FAZT-D13/4 240989			
	15	FAZT-D15/3 240910			FAZT-D15/3N 241188			FAZT-D15/4 240992			
	16	FAZT-D16/3 240915			FAZT-D16/3N 241189			FAZT-D16/4 240993			
	20 <sup>1)</sup>	FAZT-D20/3 142497			FAZT-D20/3N 142521			FAZT-D20/4 142505			
	25 <sup>1)</sup>	FAZT-D25/3 142498			FAZT-D25/3N 142522			FAZT-D25/4 142506			
	32 <sup>1)</sup>	FAZT-D32/3 142499			FAZT-D32/3N 142523			FAZT-D32/4 142507			
	40 <sup>1)</sup>	FAZT-D40/3 142500			FAZT-D40/3N 142524			FAZT-D40/4 142508			

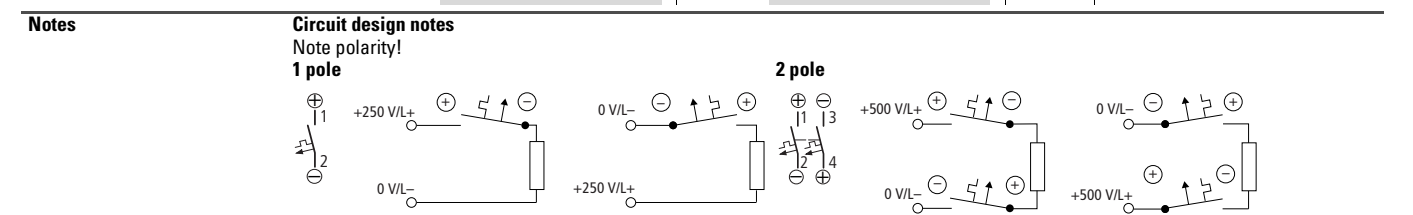
Rated operational current $I_n$ A	1 pole			2 pole			Std. pack	Notes
	Part no. Article no.	Price See price list	Notes	Part no. Article no.	Price See price list	Notes		
<b>FAZ miniature circuit-breakers for DC applications</b>								
Characteristic C Instantaneous release response current 5 - 10 x $I_n$ Switching capacity 10 kA (IEC/EN 60947-2) (L/R = 4 ms) Rated operating voltage 250 V DC per pole	2	FAZ-C2/1-DC 279122		12 off	FAZ-C2/2-DC 279134		1 off	<b>Accessories</b> <b>Page</b> Auxiliary contacts → 19/24 Shunt releases Mounting accessories → 19/25  1 pole Depth 71 mm Width 17.5 mm  2 pole; 1N pole Depth 71 mm Width 35 mm   
	3	FAZ-C3/1-DC 279123			FAZ-C3/2-DC 279135			
	4	FAZ-C4/1-DC 279124			FAZ-C4/2-DC 279136			
	6	FAZ-C6/1-DC 279125			FAZ-C6/2-DC 279137			
	10	FAZ-C10/1-DC 279126			FAZ-C10/2-DC 279138			
	13	FAZ-C13/1-DC 279127			FAZ-C13/2-DC 279139			
	16	FAZ-C16/1-DC 279128			FAZ-C16/2-DC 279140			
	20	FAZ-C20/1-DC 279129			FAZ-C20/2-DC 279141			
	25	FAZ-C25/1-DC 279130			FAZ-C25/2-DC 279142			
	32	FAZ-C32/1-DC 279131			FAZ-C32/2-DC 279143			
	40	FAZ-C40/1-DC 279132			FAZ-C40/2-DC 279144			
50	FAZ-C50/1-DC 279133			FAZ-C50/2-DC 279145				

Rated operational current $I_n$ A	1 pole			2 pole			Std. pack	Notes
	Part no. Article no.	Price See price list	Notes	Part no. Article no.	Price See price list	Notes		
<b>FAZ miniature circuit-breakers for DC applications</b>								
Characteristic C Instantaneous release response current 5 - 10 x $I_n$ Switching capacity 10 kA (IEC/EN 60947-2) (L/R = 4 ms) Rated operating voltage 250 V DC per pole	2	FAZ-C2/1-DC 279122		12 off	FAZ-C2/2-DC 279134		1 off	<b>Accessories</b> <b>Page</b> Auxiliary contacts → 19/24 Shunt releases Mounting accessories → 19/25  1 pole Depth 71 mm Width 17.5 mm  2 pole; 1N pole Depth 71 mm Width 35 mm   
	3	FAZ-C3/1-DC 279123			FAZ-C3/2-DC 279135			
	4	FAZ-C4/1-DC 279124			FAZ-C4/2-DC 279136			
	6	FAZ-C6/1-DC 279125			FAZ-C6/2-DC 279137			
	10	FAZ-C10/1-DC 279126			FAZ-C10/2-DC 279138			
	13	FAZ-C13/1-DC 279127			FAZ-C13/2-DC 279139			
	16	FAZ-C16/1-DC 279128			FAZ-C16/2-DC 279140			
	20	FAZ-C20/1-DC 279129			FAZ-C20/2-DC 279141			
	25	FAZ-C25/1-DC 279130			FAZ-C25/2-DC 279142			
	32	FAZ-C32/1-DC 279131			FAZ-C32/2-DC 279143			
	40	FAZ-C40/1-DC 279132			FAZ-C40/2-DC 279144			
50	FAZ-C50/1-DC 279133			FAZ-C50/2-DC 279145				



Rated operational current $I_n$ A	1 pole			2 pole With 2 protected poles			3 pole With 3 protected poles		
	Part no. Article no.	Price See price list	Std. pack	Part no. Article no.	Price See price list	Std. pack	Part no. Article no.	Price See price list	Std. pack
<b>AZ miniature circuit-breakers</b>									
Characteristic C Response current of short-circuit release 5 - 10 x $I_n$ Switching capacity 15 - 25 kA (IEC/EN 60947-2)	20	<b>AZ-C20</b> 211769	12 off	<b>AZ-2-C20</b> 211770		2 off	<b>AZ-3-C20</b> 211771		1 off
	25	<b>AZ-C25</b> 211774	12 off	<b>AZ-2-C25</b> 211775		2 off	<b>AZ-3-C25</b> 211776		1 off
	32	<b>AZ-C32</b> 211779	12 off	<b>AZ-2-C32</b> 211780		2 off	<b>AZ-3-C32</b> 211781		1 off
	40	<b>AZ-C40</b> 211784	12 off	<b>AZ-2-C40</b> 211785		2 off	<b>AZ-3-C40</b> 211786		1 off
	50	<b>AZ-C50</b> 211789	12 off	<b>AZ-2-C50</b> 211790		2 off	<b>AZ-3-C50</b> 211791		1 off
	63	<b>AZ-C63</b> 211794	12 off	<b>AZ-2-C63</b> 211795		2 off	<b>AZ-3-C63</b> 211796		1 off
	80	<b>AZ-C80</b> 211799	12 off	<b>AZ-2-C80</b> 211800		2 off	<b>AZ-3-C80</b> 211801		1 off
	100	<b>AZ-C100</b> 211804	12 off	<b>AZ-2-C100</b> 211805		2 off	<b>AZ-3-C100</b> 211806		1 off
	125	<b>AZ-C125</b> 211809	12 off	<b>AZ-2-C125</b> 211810		2 off	<b>AZ-3-C125</b> 211811		1 off
Characteristic D Instantaneous release response current 10 - 20 x $I_n$ Switching capacity 15 - 25 kA (IEC/EN 60947-2)	50	<b>AZ-D50</b> 211814	12 off	<b>AZ-2-D50</b> 211815		2 off	<b>AZ-3-D50</b> 211816		1 off
	63	<b>AZ-D63</b> 211818	12 off	<b>AZ-2-D63</b> 211819		2 off	<b>AZ-3-D63</b> 211820		1 off
	80	<b>AZ-D80</b> 211822	12 off	<b>AZ-2-D80</b> 211823		2 off	<b>AZ-3-D80</b> 211824		1 off
	100	<b>AZ-D100</b> 211826	12 off	<b>AZ-2-D100</b> 211827		2 off	<b>AZ-3-D100</b> 211828		1 off

4 pole With 4 protected poles	Part no. Article no.	Price See price list	Std. pack	4 pole With 3 protected poles, N switching with poles	Part no. Article no.	Price See price list	Std. pack	Notes
<b>AZ-4-C20</b> 211772			1 off	<b>AZ-3N-C20</b> 211773			1 off	For switching capacity refer to Technical Data <b>Accessories</b> <span style="float:right">Page</span> Auxiliary contacts, shunt releases → 19/24 Mounting accessories → 19/25 <div style="display: flex; justify-content: space-around;"> <div style="text-align: center;">                           1 pole Depth 75 mm Width 27 mm                     </div> <div style="text-align: center;">                           2 pole Depth 75 mm Width 54 mm                     </div> </div> <div style="display: flex; justify-content: space-around; margin-top: 10px;"> <div style="text-align: center;">                           3 pole Depth 75 mm Width 81 mm                     </div> <div style="text-align: center;">                           4 pole; 3 pole + N Depth 75 mm Width 108 mm                     </div> </div>
<b>AZ-4-C25</b> 211777			1 off	<b>AZ-3N-C25</b> 211778			1 off	
<b>AZ-4-C32</b> 211782			1 off	<b>AZ-3N-C32</b> 211783			1 off	
<b>AZ-4-C40</b> 211787			1 off	<b>AZ-3N-C40</b> 211788			1 off	
<b>AZ-4-C50</b> 211792			1 off	<b>AZ-3N-C50</b> 211793			1 off	
<b>AZ-4-C63</b> 211797			1 off	<b>AZ-3N-C63</b> 211798			1 off	
<b>AZ-4-C80</b> 211802			1 off	<b>AZ-3N-C80</b> 211803			1 off	
<b>AZ-4-C100</b> 211807			1 off	<b>AZ-3N-C100</b> 211808			1 off	
<b>AZ-4-C125</b> 211812			1 off	<b>AZ-3N-C125</b> 211813			1 off	
				<b>AZ-3N-D50</b> 211817			1 off	
				<b>AZ-3N-D63</b> 211821			1 off	
				<b>AZ-3N-D80</b> 211825			1 off	
				<b>AZ-3N-D100</b> 211829			1 off	

WWW.TM2A.PT info@tm2a.pt

WWW.TM2A.PT info@tm2a.pt

Rated uninterrupted current $I_u$ A	2 pole		4 pole		Std. pack
	Part no. Article no.	Price See price list	Part no. Article no.	Price See price list	

Residual-current protective modules for FAZ					
Rated fault current $I_{\Delta N} = 30 \text{ mA}$	40	<b>FIM-40/2/0.03-A</b> 278510	<b>FIM-40/4/0.03-A</b> 278514		1 off
Rated fault current $I_{\Delta N} = 30 \text{ mA}$	63	<b>FIM-63/2/0.03-A</b> 278512	<b>FIM-63/4/0.03-A</b> 278516		
Rated fault current $I_{\Delta N} = 300 \text{ mA}$	40	<b>FIM-40/2/0.3-A</b> 278511	<b>FIM-40/4/0.3-A</b> 278515		
Rated fault current $I_{\Delta N} = 300 \text{ mA}$	63	<b>FIM-63/2/0.3-A</b> 278513	<b>FIM-63/4/0.3-A</b> 278517		

Rated uninterrupted current $I_u$ A	2 pole		4 pole		4 pole Selective		Std. pack
	Part no. Article no.	Price See price list	Part no. Article no.	Price See price list	Part no. Article no.	Price See price list	

Residual-current protective modules for AZ					
Rated fault current $I_{\Delta N} = 30 \text{ mA}$	80		<b>AZFIMP-4-80-0,03</b> 255484		1 off
Rated fault current $I_{\Delta N} = 30 \text{ mA}$	125		<b>AZFIMP-4-125-0,03</b> 255488		
Rated fault current $I_{\Delta N} = 300 \text{ mA}$	80	<b>AZFIMP-2-80-0,3</b> 255477	<b>AZFIMP-4-80-0,3</b> 255485	<b>AZFIMS-4-80-0,3</b> 255492	
Rated fault current $I_{\Delta N} = 300 \text{ mA}$	125	<b>AZFIMP-2-125-0,3</b> 255481	<b>AZFIMP-4-125-0,3</b> 255489	<b>AZFIMS-4-125-0,3</b> 255495	

Notes

FIM-.../2/...

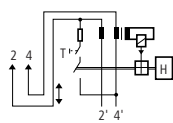

FIM-.../4/...

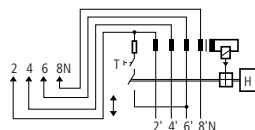

AZFIMP-2-...

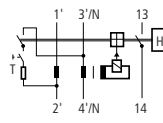

AZFIMP-4-...  
AZFIMS-4-...

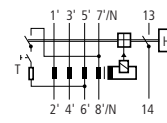

Pole	Rated operational current $I_n$ A	Response value Earth-fault release $I_{\Delta n}$ A	Part no. Article no.	Price See price list	Std. pack
------	---	--	-------------------------	-------------------------	-----------

Leakage current meter

- 4 pole, can also be used as 2 and 3 pole
- Electronic operation (independent of mains voltage)

- , non-delayed

- Type G or part no. S can be set
- → 19/55

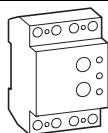

4 pole	40	0.03 0.1 0.3 0.5 1.0	<b>PDIM-40/4</b> 111760		1 off
4 pole	100	0.03 0.1 0.3 0.5 1.0	<b>PDIM-100/4</b> 111761		1 off

	Rated operational current $I_n$ A	2 pole		2 pole		Std. pack
		Part no. Article no. Rated fault current $I_{\Delta N} = 30 \text{ mA}$	Price See price list	Part no. Article no. Rated fault current $I_{\Delta N} = 300 \text{ mA}$	Price See price list	
<b>PKNM combination switches, type A</b>						
Characteristic B Switching capacity 10 kA	6	<b>PKNM-6/1N/B/003-A-DW</b> 238580		<b>PKNM-6/1N/B/03-A-DW</b> 238582		1 off
	10	<b>PKNM-10/1N/B/003-A-DW</b> 238640		<b>PKNM-10/1N/B/03-A-DW</b> 238642		
	13	<b>PKNM-13/1N/B/003-A-DW</b> 238701		<b>PKNM-13/1N/B/03-A-DW</b> 238703		
	16	<b>PKNM-16/1N/B/003-A-DW</b> 238773		<b>PKNM-16/1N/B/03-A-DW</b> 238775		
	20	<b>PKNM-20/1N/B/003-A-DW</b> 238807		<b>PKNM-20/1N/B/03-A-DW</b> 238809		
	25	<b>PKNM-25/1N/B/003-A-DW</b> 238837		<b>PKNM-25/1N/B/03-A-DW</b> 238839		
	32	<b>PKNM-32/1N/B/003-A-DW</b> 238867		<b>PKNM-32/1N/B/03-A-DW</b> 238869		
	40	<b>PKNM-40/1N/B/003-A-DW</b> 238896		<b>PKNM-40/1N/B/03-A-DW</b> 238898		
Characteristic C Switching capacity 10 kA	6	<b>PKNM-6/1N/C/003-A-DW</b> 238590		<b>PKNM-6/1N/C/03-A-DW</b> 238592		
	10	<b>PKNM-10/1N/C/003-A-DW</b> 238650		<b>PKNM-10/1N/C/03-A-DW</b> 238652		
	13	<b>PKNM-13/1N/C/003-A-DW</b> 238713		<b>PKNM-13/1N/C/03-A-DW</b> 238715		
	16	<b>PKNM-16/1N/C/003-A-DW</b> 238785		<b>PKNM-16/1N/C/03-A-DW</b> 238787		
	20	<b>PKNM-20/1N/C/003-A-DW</b> 238817		<b>PKNM-20/1N/C/03-A-DW</b> 238819		
	25	<b>PKNM-25/1N/C/003-A-DW</b> 238847		<b>PKNM-25/1N/C/03-A-DW</b> 238849		
	32	<b>PKNM-32/1N/C/003-A-DW</b> 238877		<b>PKNM-32/1N/C/03-A-DW</b> 238879		
	40	<b>PKNM-40/1N/C/003-A-DW</b> 238906		<b>PKNM-40/1N/C/03-A-DW</b> 238908		

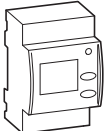
	Pole	Description	Rated operational current $I_n$ A	Part no. Article no.	Price See price list	Std. pack
<b>Power meter</b>						
Power meter to IEC/EN 62053 for sub measurements						
<ul style="list-style-type: none"> <li>For active/reactive energy</li> <li>Three-phase models also suitable for unbalanced load</li> <li>Programmable through 2 keys on device front</li> <li>Front plate and terminal area can be sealed</li> </ul>						
	3 + N	Connection through current transformer	5	<b>KWZ-3PH</b> 110825		1 off
	3 + N	Connection through current transformer	63	<b>KWZ-3PH-63</b> 110826		

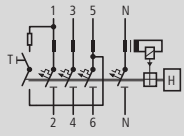
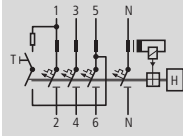
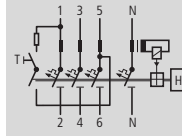
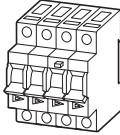
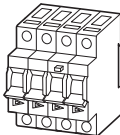
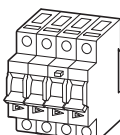
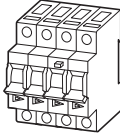
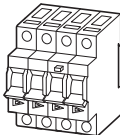

		3 pole + N	3 pole + N	3 pole + N		Std. pack
	Rated operational current $I_n$ A	 <p><b>Part no.</b> Article no.</p> <p>Rated fault current <math>I_{\Delta N} = 30</math> mA</p>	 <p><b>Part no.</b> Article no.</p> <p>Rated fault current <math>I_{\Delta N} = 100</math> mA</p>	 <p><b>Part no.</b> Article no.</p> <p>Rated fault current <math>I_{\Delta N} = 300</math> mA</p>	<b>Price</b> See price list	
<b>FI/LS combination switches mRB6</b>						
<ul style="list-style-type: none"> <li>Conditionally surge-proof 250 A</li> <li>Pulse-current sensitive, Type A</li> <li>Depth 75 mm</li> <li>Width 70 mm</li> </ul>						
Characteristic B Switching capacity 6 kA  	13	<b>mRB6-13/3N/B/003-A</b> 120651	<b>mRB6-13/3N/B/01-A</b> 120653	<b>mRB6-13/3N/B/03-A</b> 120655		1 off
	16	<b>mRB6-16/3N/B/003-A</b> 120652	<b>mRB6-16/3N/B/01-A</b> 120654	<b>mRB6-16/3N/B/03-A</b> 120656		1 off
Characteristic C Switching capacity 6 kA  	6	<b>mRB6-6/3N/C/003-A</b> 120657	<b>mRB6-6/3N/C/01-A</b> 120661	<b>mRB6-6/3N/C/03-A</b> 120665		1 off
	10	<b>mRB6-10/3N/C/003-A</b> 120658	<b>mRB6-10/3N/C/01-A</b> 120662	<b>mRB6-10/3N/C/03-A</b> 120666		1 off
	13	<b>mRB6-13/3N/C/003-A</b> 120659	<b>mRB6-13/3N/C/01-A</b> 120663	<b>mRB6-13/3N/C/03-A</b> 120667		1 off
	16	<b>mRB6-16/3N/C/003-A</b> 120660	<b>mRB6-16/3N/C/01-A</b> 120664	<b>mRB6-16/3N/C/03-A</b> 120668		1 off
Characteristic D Switching capacity 6 kA  	6	<b>mRB6-6/3N/D/003-A</b> 120669	<b>mRB6-6/3N/D/01-A</b> 120673			1 off
	10	<b>mRB6-10/3N/D/003-A</b> 120670	<b>mRB6-10/3N/D/01-A</b> 120674			1 off
	13	<b>mRB6-13/3N/D/003-A</b> 120671	<b>mRB6-13/3N/D/01-A</b> 120675			1 off
	16	<b>mRB6-16/3N/D/003-A</b> 120672	<b>mRB6-16/3N/D/01-A</b> 120676			1 off
<b>FI-LS combination switches mRB4</b>						
<ul style="list-style-type: none"> <li>Conditionally surge-proof 250 A</li> <li>Pulse-current sensitive, Type A</li> <li>Depth 75 mm</li> <li>Width 70 mm</li> </ul>						
Characteristic C Switching capacity 4.5 kA  	20	<b>mRB4-20/3N/C/003-A</b> 120677	<b>mRB4-20/3N/C/01-A</b> 120679	<b>mRB4-20/3N/C/03-A</b> 120681		1 off
	25	<b>mRB4-25/3N/C/003-A</b> 120678	<b>mRB4-25/3N/C/01-A</b> 120680	<b>mRB4-25/3N/C/03-A</b> 120682		1 off
Characteristic D Switching capacity 4.5 kA  	20	<b>mRB4-20/3N/D/003-A</b> 120683	<b>mRB4-20/3N/D/01-A</b> 120684			1 off

WWW.TM2A.PT info@tm2a.pt

WWW.TM2A.PT info@tm2a.pt



Rated uninterrupted current $I_u$ A	2 pole		Std. pack	4 pole		Std. pack
	Part no. Article no.	Price See price list		Part no. Article no.	Price See price list	
<b>Residual-current devices FI, type A</b>						
Rated fault current $I_{\Delta N} = 30 \text{ mA}$	16	<b>FI-16/2/003-A</b> 279183	1 off			1 off
	25	<b>FI-25/2/003-A</b> 279184	1 off		<b>FI-25/4/003-A</b> 279213	
	40	<b>FI-40/2/003-A</b> 279187	1 off		<b>FI-40/4/003-A</b> 279217	
	63				<b>FI-63/4/003-A</b> 279221	
	80				<b>FI-80/4/003-A</b> 279225	
	100				<b>FI-100/4/003-A/-</b> 102936	
	125				<b>FI-125/4/003-A</b> 279165	
Rated fault current $I_{\Delta N} = 100 \text{ mA}$	25	<b>FI-25/2/01-A</b> 279185	1 off		<b>FI-25/4/01-A</b> 279214	
	40	<b>FI-40/2/01-A</b> 279188	1 off		<b>FI-40/4/01-A</b> 279218	
	63				<b>FI-63/4/01-A</b> 279222	
Rated fault current $I_{\Delta N} = 300 \text{ mA}$	25	<b>FI-25/2/03-A</b> 279186	1 off		<b>FI-25/4/03-A</b> 279215	
	40	<b>FI-40/2/03-A</b> 279189	1 off		<b>FI-40/4/03-A</b> 279219	
	63				<b>FI-63/4/03-A</b> 279223	
	80				<b>FI-80/4/03-A</b> 279226	
	100				<b>FI-100/4/03-A/-</b> 102937	
	125				<b>FI-125/4/03-A</b> 279167	
Rated fault current $I_{\Delta N} = 500 \text{ mA}$	25				<b>FI-25/4/05-A</b> 279216	
	40				<b>FI-40/4/05-A</b> 279220	
	63				<b>FI-63/4/05-A</b> 279224	
	80				<b>FI-80/4/05-A</b> 279227	
	100				<b>FI-100/4/05-A/-</b> 102938	
	125				<b>FI-125/4/05-A</b> 279169	

Notes

≤ 100 A

125 A

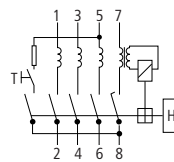
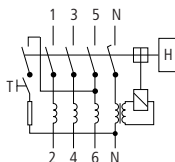
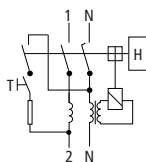

4 pole

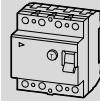

Rated uninterrupted current  
 $I_u$   
A

Part no.  
Article no.

Price  
See price list

Std. pack

Notes

**Suitable for frequency inverters, type U**

Rated fault current $I_{\Delta N} = 100 \text{ mA}$	40	<b>FI-40/4/01-U</b> 279234	1 off
	63	<b>FI-63/4/01-U</b> 279236	1 off
Rated fault current $I_{\Delta N} = 300 \text{ mA}$	40	<b>FI-40/4/03-U</b> 279235	1 off
	63	<b>FI-63/4/03-U</b> 279237	1 off

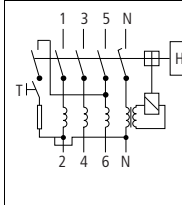

**Selective and surge-proof 5 kA, type S/A**

Rated fault current $I_{\Delta N} = 100 \text{ mA}$	63	<b>FI-63/4/01-S/A</b> 279228	1 off
	63	<b>FI-63/4/03-S/A</b> 279229	1 off
Rated fault current $I_{\Delta N} = 300 \text{ mA}$	80	<b>FI-80/4/03-S/A</b> 279230	1 off

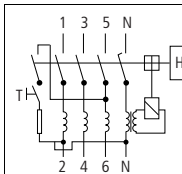

**AC/DC sensitive, Type B**

Rated fault current $I_{\Delta N} = 30 \text{ mA}$	40	<b>FI-40/4/003-B</b> 240710	1 off
	63	<b>FI-63/4/003-B</b> 240711	1 off
	80	<b>FI-80/4/003-B</b> 240712	1 off
	125 <sup>1)</sup>	<b>FI-125/4/003-B</b> 240717	1 off
Rated fault current $I_{\Delta N} = 100 \text{ mA}$	40	<b>FI-40/4/01-B</b> 279170	1 off
	63	<b>FI-63/4/01-B</b> 279171	1 off
	80	<b>FI-80/4/01-B</b> 279172	1 off
	125 <sup>1)</sup>	<b>FI-125/4/01-B</b> 240722	1 off
Rated fault current $I_{\Delta N} = 300 \text{ mA}$	40	<b>FI-40/4/03-B</b> 279173	1 off
	63	<b>FI-63/4/03-B</b> 279174	1 off
	80	<b>FI-80/4/03-B</b> 279175	1 off
	125 <sup>1)</sup>	<b>FI-125/4/03-B</b> 240727	1 off

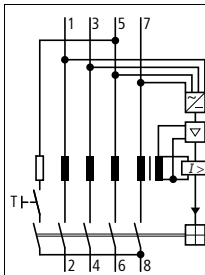

For use in 50 Hz AC current systems with electrical equipment such as frequency inverters, UPS systems or switched-mode power supply units. During a malfunction electrical equipment can cause AC fault currents and pulsed DC fault currents as well as smoothed d.c. fault currents, where residual-current devices of type C will not trip. The residual-current devices FI-B detect all fault current types in accordance with the trip characteristic of IEC 60755, i.e. even pulsating d.c. fault current.

- Caution: In some countries the insurance companies place special demands on residual-current devices.
- Contact position display red-green
- Position independent function
- Trip occurs independent of the mains voltage (currents type AC and A)
- 30 V AC necessary for detection of type B current
- Mains connection side at top
- Type S/B 40 ms delay and selective switch off
- Auxiliary contacts on request

**AC/DC sensitive, selective, S/B type**

Rated fault current $I_{\Delta N} = 300 \text{ mA}$	40	<b>FI-40/4/03-S/B</b> 281022	1 off
	63	<b>FI-63/4/03-S/B</b> 281023	1 off
	80	<b>FI-80/4/03-S/B</b> 281024	1 off

Notes

<sup>1)</sup> Neutral conductor right, with 125 A neutral conductor on left

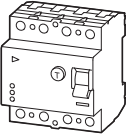
	Rated operational current $I_n$ A	Part no. Article no.	Price See price list	Std. pack	
<b>Residual-current devices dRCM, digital</b>					
<ul style="list-style-type: none"> <li>• 4 pole</li> <li>• Contact position display red-green</li> <li>• Trip indication white/blue</li> </ul>					
	Surge-proof 3 kA, pulse-current sensitive, Type G/A				
	Rated fault current $I_{\Delta N} = 30$ mA	25	<b>dRCM-25/4/003-G/A+</b> 120834		1 off
		40	<b>dRCM-40/4/003-G/A+</b> 120836		1 off
		63	<b>dRCM-63/4/003-G/A+</b> 120838		1 off
		80	<b>dRCM-80/4/003-G/A+</b> 120840		1 off
	Rated fault current $I_{\Delta N} = 300$ mA	25	<b>dRCM-25/4/03-G/A+</b> 120835		1 off
		40	<b>dRCM-40/4/03-G/A+</b> 120837		1 off
		63	<b>dRCM-63/4/03-G/A+</b> 120839		1 off
		80	<b>dRCM-80/4/03-G/A+</b> 120841		1 off
	Surge-proof 3 kA, X-ray applications, Type R				
	Rated fault current $I_{\Delta N} = 30$ mA	63	<b>dRCM-63/4/003-R+</b> 120842		1 off
	Selective and surge-proof typ. 5 kA, pulse-current sensitive, Type S/A				
Rated fault current $I_{\Delta N} = 300$ mA	40	<b>dRCM-40/4/03-S/A+</b> 120843		1 off	
	63	<b>dRCM-63/4/03-S/A+</b> 120844		1 off	
	80	<b>dRCM-80/4/03-S/A+</b> 120845		1 off	
Selective and surge-proof typ. 5 kA, suitable for frequency inverters, Type U					
Rated fault current $I_{\Delta N} = 300$ mA	40	<b>dRCM-40/4/03-U+</b> 120851		1 off	
	63	<b>dRCM-63/4/03-U+</b> 120847		1 off	
	80	<b>dRCM-80/4/03-U+</b> 120848		1 off	
Short-time delayed and surge-proof 3 kA, suitable for frequency inverters, Type U					
Rated fault current $I_{\Delta N} = 30$ mA	40	<b>dRCM-40/4/003-U+</b> 120850		1 off	
	63	<b>dRCM-63/4/003-U+</b> 120846		1 off	

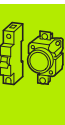

		Part no. Article no.	Price See price list	Std. pack	Information relevant for export to North America 
<b>Remote monitoring unit</b>					
<ul style="list-style-type: none"> <li>GSM-based universal remote monitoring and control through SMS</li> <li>Configuration and status monitoring through SMS</li> <li>Built-in modem monitoring and associated status indication through front-mounted LEDs</li> <li>2 changeover contacts</li> <li>4 digital inputs, 2 relay outputs</li> </ul>					
		Z-CC/2CO 119383		1 off	
<b>Accessories for remote monitoring unit</b>					
Power adaptor	24 V, 0.2 A	EASY200-POW 229424		1 off 	Product Standards IEC/EN see Technical Data; UL 508; CSA C22.2 No. 142-M1987; CSA C22.2 No. 213-M1987; CE marking UL File No. E135462 UL CCN NRAQ CSA File No. 012528 CSA Class No. 2252-01 + 2258-02 NA Certification UL Listed, CSA certified Degree of Protection IEC: IP20, UL/CSA Type: -
Temperature sensor		Z-CC/2CO-SE 119430		1 off	







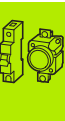
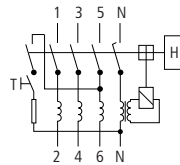
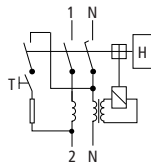



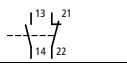

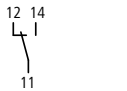

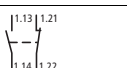

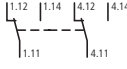

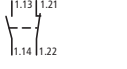



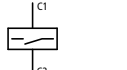

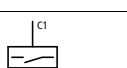

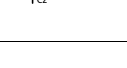
		Part no. Article no.	Price See price list	Std. pack
<b>Remote switching modules</b>				
<ul style="list-style-type: none"> <li>IEC/EN 60669-2-2</li> <li>For remote switching and automatic restart of FAZ miniature circuit-breakers and FI residual-current devices up to 80 A, except Type B</li> <li>Mechanically lockable and sealable</li> <li>LED indication of operational status and alarm status</li> <li>Mechanical switching capacity up to FAZ-...63 and up to FI-80..., except Type B (-XFSM)</li> <li>-25 °C/+40 °C</li> <li>Rated operating voltage 24 - 240 V AC, 24 - 48 V DC</li> <li>Terminal capacity 2 x 1.5 mm<sup>2</sup>, 1 x 2.5 mm<sup>2</sup>; 0.4 Nm</li> <li>Mechanical/electrical lifespan 10 000 switching operations</li> <li>Power consumption 5 W</li> </ul>				
	220 - 240 V AC	FAZ/FIP-XAWM 262514		1 off
	48 V DC	FAZ/FIP-XDWM 274404		1 off
<b>Remote test module</b>				
<ul style="list-style-type: none"> <li>External test module with test resistor for RCCB devices</li> <li>Version adapted for rated fault currents with stipulated "external" test button function</li> </ul>				
	0.01 A	Z-FW/001 248297		4 off
	0.03 A	Z-FW/003 248298		4 off
	0.1 A	Z-FW/010 248299		4 off
	0.3 A	Z-FW/030 248300		4 off
	0.5 A	Z-FW/050 248301		4 off

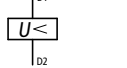
	2 pole			Std. pack	4 pole			Std. pack	4 pole Selective and surge-proof 5 kA			
	Rated uninterrupted current $I_u$ A	Part no. Article no.	Price See price list		Part no. Article no.	Price See price list	Part no. Article no.		Price See price list	Std. pack		
<b>FI residual-current devices, only for export (AC type)</b>												
Rated fault current $I_{\Delta N} = 30 \text{ mA}$	16	<b>FI-16/2/003</b> 279176		1 off				1 off				
	25	<b>FI-25/2/003</b> 279177			<b>FI-25/4/003</b> 279196							
	40	<b>FI-40/2/003</b> 279180			<b>FI-40/4/003</b> 279200							
	63	<b>FI-63/2/003</b> 279190			<b>FI-63/4/003</b> 279204							
	80	<b>FI-80/2/003</b> 279192			<b>FI-80/4/003</b> 279208							
Rated fault current $I_{\Delta N} = 100 \text{ mA}$	25	<b>FI-25/2/01</b> 279178			<b>FI-25/4/01</b> 279197							
	40	<b>FI-40/2/01</b> 279181			<b>FI-40/4/01</b> 279201							
	63	<b>FI-63/2/01</b> 279191			<b>FI-63/4/01</b> 279205				<b>FI-63/4/01-S</b> 279210		1 off	
	80	<b>FI-80/2/01</b> 279193			<b>FI-80/4/01</b> 279231							
Rated fault current $I_{\Delta N} = 300 \text{ mA}$	25	<b>FI-25/2/03</b> 279179			<b>FI-25/4/03</b> 279198							
	40	<b>FI-40/2/03</b> 279182			<b>FI-40/4/03</b> 279202							
	80				<b>FI-63/4/03</b> 279206				<b>FI-63/4/03-S</b> 279211		1 off	
	25				<b>FI-80/4/03</b> 279209				<b>FI-80/4/03-S</b> 279212		1 off	
Rated fault current $I_{\Delta N} = 500 \text{ mA}$	40				<b>FI-25/4/05</b> 279199							
	63				<b>FI-40/4/05</b> 279203							
	16				<b>FI-63/4/05</b> 279207							

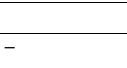
Notes



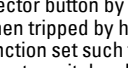





For use with	Contacts Number	Contact sequences	Space units, 1 space unit = 18 mm Space unit	Part no. Article no.	Price See price list	Std. pack
<b>Auxiliary contacts and shunt releases</b>						
<b>Auxiliary contacts for FAZ, AZ, PKNM</b>						
	FAZ... PKNM... to 63 A	1 N/O/ 1 NC		0.5	<b>FAZ-XHIN11<sup>3)</sup></b> 286054	10 off 
	FAZ... PKNM... to 63 A	1 C		0.5	<b>FAZ-XHINW1<sup>4)</sup></b> 286055	10 off 
	AZ... to 125 A	1 N/O/ 1 NC		0.5	<b>AZ-XHI11</b> 212067	8 off
<b>Trip-indicating auxiliary contact/auxiliary contact for FAZ, PKNM<sup>1)</sup></b>						
	FAZ... PKNM... to 63 A	2 C		0.5	<b>FAZ-XAM002<sup>5)</sup></b> 262414	10 off 
<b>Auxiliary contacts for FI</b>						
	FI... 16 - 100 A, except type B	1 N/O/ 1 NC		0.5	<b>FIP-XHI11</b> 225121	10 off
	FI... <sup>2)</sup> 125 A and all type B	1 NC / 1 N/O		0.5	<b>FIPA-XAM011</b> 262578	1 off
<b>Shunt releases for FAZ, PKNM, AZ</b>						
	FAZ... PKNM... to 63 A	–		1	<b>FAZ-XAA-C-12-110VAC</b> 278518	1 off
	FAZ... PKNM... to 63 A	–		1	<b>FAZ-XAA-C-110-415VAC</b> 278519	1 off
	AZ... to 125 A	–		1.5	<b>AZ-XAA(110-415VAC)</b> 212059	8 off
	AZ... to 125 A	–		1.5	<b>AZ-XAA(12-60VAC)</b> 212061	8 off
<b>Undervoltage releases for FAZ</b>						
	FAZ... –	–		1	<b>FAZ-XUA(115VAC)</b> 212049	7 off
	FAZ... –	–		1	<b>FAZ-XUA(230VAC)</b> 212051	7 off
	FAZ... –	–		1	<b>FAZ-XUA(400VAC)</b> 212053	7 off
<b>MCB lock for FAZ/FIP</b>						
	FAZ... FIP... –	–	–	–	<b>IS/SPE-1TE</b> 101911	5 off

**Notes**

- The device is supplied with the groove in the yellow selector button in the horizontal: Changeover contact 4.11 – 4.12/4.14 switches when tripped manually or electrically. Turning the yellow selector button by 90° results in contact 4.11 – 4.12/4.14 responding only to electrical tripping: the contact 4.11 – 4.12/4.14 remains closed when tripped by hand.
- The device is supplied with the "Auxiliary contacts" function set such that both contacts switch on manual **and** electrical tripping. A change of function to "Signalling switch" means that both contacts switch **only** under fault conditions.

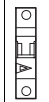
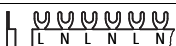
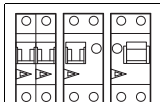
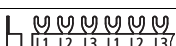
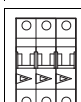
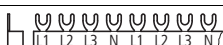
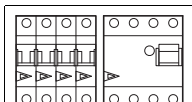
**Information relevant for export to North America**

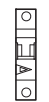
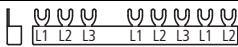
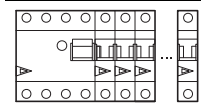
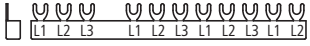
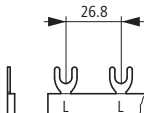

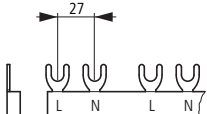
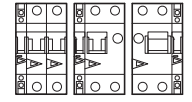
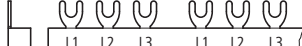
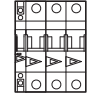
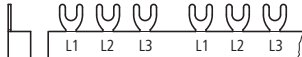



- Product Standards IEC/EN 60947-2; IEC/EN 60898; UL 1077; CSA-C22.2 No. 235; CE marking  
UL File No. E177451  
UL CCN QVNU2, QVNU9  
CSA File No. –  
CSA Class No. 3215-30  
NA Certification UL Recognized, certified by UL for use in Canada  
Degree of Protection IEC: IP20; UL/CSA Type: –
- Product Standards IEC/EN 60947-2; IEC/EN 60898; UL 1077; CSA-C22.2 No. 235; CE marking  
UL File No. E177451  
UL CCN QVNU2  
NA Certification UL Recognized, request filed for CSA  
Degree of Protection IEC: IP20; UL/CSA Type: –
- Product Standards IEC/EN 60947-2; IEC/EN 60898; UL 1077; CSA-C22.2 No. 235; CE marking  
UL File No. E177451  
UL CCN QVNU2, QVNU8  
CSA File No. –  
CSA Class No. 3215-30  
NA Certification UL Recognized, certified by UL for use in Canada  
Degree of Protection IEC: IP20; UL/CSA Type: –

	Phases Number	Devices Number	Part no. Article no.	Price See price list	Std. pack	Notes
<b>Euro-Vario busbars (fork connector)</b>						
<ul style="list-style-type: none"> <li>No end caps required</li> <li>Do not shorten</li> </ul>						
<b>10 mm<sup>2</sup></b>						
<ul style="list-style-type: none"> <li>Rated operational current 63 A</li> </ul>						
For PXL, PXF, PKX, PFIM-U, PFNM						
	1	2	<b>EVG-1PHAS/2MODUL</b> 215646		40 off	
	1	6	<b>EVG-1PHAS/6MODUL</b> 215638		40 off	
	1	12	<b>EVG-1PHAS/12MODUL</b> 215637		40 off	
	2	4	<b>EVG-2PHAS/4MODUL</b> 268220		20 off	
	2	6	<b>EVG-2PHAS/6MODUL</b> 215642		20 off	
	2	12	<b>EVG-2PHAS/12MODUL</b> 215641		20 off	
	3	6	<b>EVG-3PHAS/6MODUL</b> 215640		20 off	
	3	9	<b>EVG-3PHAS/9MODUL</b> 215645		20 off	
	3	12	<b>EVG-3PHAS/12MODUL</b> 215639		20 off	
	3	16	<b>EVG-3PHAS/16MODUL</b> 285381		20 off	
	3	20	<b>EVG-3PHAS/20MODUL</b> 285383		10 off	
	4	8	<b>EVG-4PHAS/8MODUL</b> 215644		10 off	
	4	12	<b>EVG-4PHAS/12MODUL</b> 215643		10 off	
	4	16	<b>EVG-3P+3N/16MODUL</b> 105215		20 off	
	4	18	<b>EVG-3P+3N/18MODUL</b> 274161		20 off	
For 2 pole combination RCCB/circuit-breaker with a width of 3 space units						
	1	2 - 5	<b>EVG-1PHAS/2-5MODUL/FILS</b> 285384		40 off	
For combined use of 4 pole residual-current devices with miniature circuit-breakers						
	3	4 + 5	<b>EVG-3PHAS/N/5MODUL/LS</b> 215659		20 off	
	3	4 + 8	<b>EVG-3PHAS/N/8MODUL/LS</b> 215660		20 off	
For use with auxiliary contacts						
	1	2.5	<b>EVG-1PHAS/2MODUL/HI</b> 215655		40 off	
	1	13	<b>EVG-1PHAS/9MODUL/HI</b> 215656		40 off	
	2	4.5	<b>EVG-2PHAS/4MODUL/HI</b> 219573		20 off	
	2	12	<b>EVG-2PHAS/10MODUL/HI</b> 215657		20 off	
	3	6.5	<b>EVG-3PHAS/6MODUL/HI</b> 216411		20 off	
	3	13.5	<b>EVG-3PHAS/12MODUL/HI</b> 215658		20 off	

WWW.TM2A.PT info@tm2a.pt

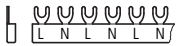
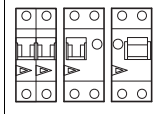
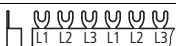
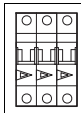
WWW.TM2A.PT info@tm2a.pt

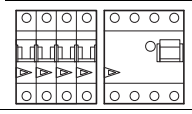
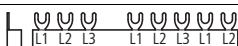
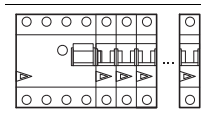
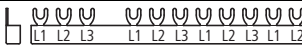
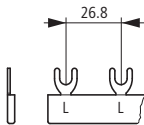

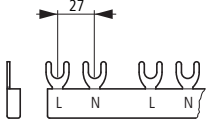
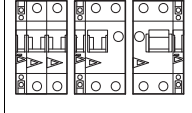
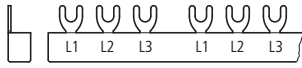
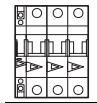
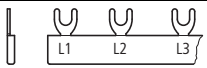
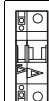

	Phases Number	Devices Number	Part no. Article no.	Price See price list	Std. pack	Notes
<b>Euro-Vario busbars (fork connector)</b>						
<ul style="list-style-type: none"> <li>No end caps required</li> <li>Do not shorten</li> </ul>						
<b>16 mm<sup>2</sup></b>						
<ul style="list-style-type: none"> <li>Rated operational current 100 A</li> </ul>						
For FAZ..., FI...						
	1	2	<b>EVG-16/1PHAS/2MODUL</b> 291464		40 off	
	1	6	<b>EVG-16/1PHAS/6MODUL</b> 291465		40 off	
	1	12	<b>EVG-16/1PHAS/12MODUL</b> 291466		40 off	
	2	4	<b>EVG-16/2PHAS/4MODUL</b> 291467		20 off	
	2	6	<b>EVG-16/2PHAS/6MODUL</b> 291468		20 off	
	2	12	<b>EVG-16/2PHAS/12MODUL</b> 291469		20 off	
	3	6	<b>EVG-16/3PHAS/6MODUL</b> 291470		20 off	
	3	9	<b>EVG-16/3PHAS/9MODUL</b> 291471		20 off	
	3	12	<b>EVG-16/3PHAS/12MODUL</b> 291472		20 off	
	3	16	<b>EVG-16/3PHAS/16MODUL</b> 291473		20 off	
	3	20	<b>EVG-16/3PHAS/20MODUL</b> 291474		10 off	
	4	8	<b>EVG-16/4PHAS/8MODUL</b> 291475		10 off	
	4	12	<b>EVG-16/4PHAS/12MODUL</b> 291476		10 off	
For combined use of 4 pole residual-current devices with miniature circuit-breakers						
	3	4 + 5	<b>EVG-16/3PHAS/N/5MODUL/LS</b> 291477		20 off	
	3	4 + 8	<b>EVG-16/3PHAS/N/8MODUL/LS</b> 291478		20 off	
For use with auxiliary contacts						
	1	2	<b>EVG-16/1PHAS/2MODUL/HI</b> 291479		20 off	
	1	6	<b>EVG-16/1PHAS/6MODUL/HI</b> 291480		40 off	
	1	9	<b>EVG-16/1PHAS/9MODUL/HI</b> 291481		40 off	
	2	2	<b>EVG-16/2PHAS/4MODUL/HI</b> 291482		20 off	
	2	3	<b>EVG-16/2PHAS/6MODUL/HI</b> 291483		20 off	
	2	5	<b>EVG-16/2PHAS/10MODUL/HI</b> 291484		20 off	
	3	2	<b>EVG-16/3PHAS/6MODUL/HI</b> 291485		20 off	
	3	4	<b>EVG-16/3PHAS/12MODUL/HI</b> 291486		20 off	
	3 x 1	6	<b>EVG-16/3X1PHAS/6MODUL/HI</b> 291487		20 off	
	3 x 1	8	<b>EVG-16/3X1PHAS/8MODUL/HI</b> 291488		20 off	
	3 x 1	9	<b>EVG-16/3X1PHAS/9MODUL/HI</b> 291489		20 off	

WWW.TM2A.PT info@tm2a.pt

WWW.TM2A.PT info@tm2a.pt

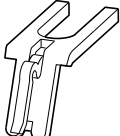
HPL19027EN

	Pole	Rated operational current $I_e$ A	Cross section  mm <sup>2</sup>	Length  m	Part no. Article no.	Price See price list	Std. pack
<b>Comb-shaped phase busbar</b>							
1-phase, 80 A	1	80	16	1	<b>Z-GV-16/1P-1TE</b> 271061		50 off
3-phase, 63 A	3	63	10	1	<b>Z-GV-10/3P-3TE</b> 271060		20 off
3-phase, 80 A	3	80	16	1	<b>Z-GV-16/3P-3TE</b> 271064		20 off
4-phase, 80 A	4	80	16	1	<b>Z-GV-16/3P+N-4TE</b> 271066		15 off
End caps	3	–	10	–	<b>Z-AK-10/2+3P</b> 271069		10 off
	3	–	16	–	<b>Z-AK-16/2+3P</b> 271070		10 off
	4	–	16	–	<b>Z-AK-16/4P</b> 271071		10 off
<b>Incoming terminals</b>							
4.3 Nm, touch-proof busbar connection to miniature circuit-breaker	–	–	25	–	<b>FAZ-XK25</b> 212116		50 off
M5: 3.0 Nm, M8: 4.3 Nm touch-proof connection to FAZ-XIS... busbar	–	–	35	–	<b>FAZ-XK35</b> 212119		10 off
<b>Busbar tag shroud</b>							
For masking of unused connections on the busbar	–	–	–	–	<b>ZV-BS-G</b> 104903		10 off
Bracket for securing of covers 2 required per row of MCBs	–	–	–	–	<b>REG-BB</b> 212106		20 off
<b>Terminal bracket, 80 A</b>							
Same extension terminal, turned by 180°							
	L1, N	80	–	–	<b>ZV-L1/N-80A-10</b> 263950		10 off
	L1, N	80	–	–	<b>ZV-L1/N-80A-36</b> 263951		36 off
	L1, N	80	–	–	<b>ZV-L1/N-80A-100</b> 263952		100 off
	L2, L3	80	–	–	<b>ZV-L2/L3-80A-10</b> 263953		10 off
	L2, L3	80	–	–	<b>ZV-L2/L3-80A-36</b> 263954		36 off
	L2, L3	80	–	–	<b>ZV-L2/L3-80A-100</b> 263955		100 off
<b>Busbars</b>							
1 m long.							
	–	50	–	1	<b>ZV-SS</b> 263956		10 off
	–	80	–	1	<b>ZV-SS-80A</b> 263957		10 off
<b>Shroud section</b>							
1 m long, for 50 and 80 A.							
–	–	–	–	–	<b>ZV-ADP</b> 263958		1 off
<b>End cap for shroud section</b>							
–	–	–	–	–	<b>ZV-AEK</b> 263959		10 off

WWW.TM2A.PT info@tm2a.pt

WWW.TM2A.PT info@tm2a.pt

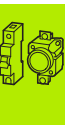

Rated operational current $I_n$ A	Interrupting capacity (SCCR) kA	Special approval for protection of AWG 18 or AWG 16 to NFPA70 (NEC) and NFPA 79	1 pole		Std. pack	2 pole		Std. pack
			Part no. Article no.	Price See price list		Part no. Article no.	Price See price list	
<b>Miniature circuit-breakers FAZ-NA</b>								
<ul style="list-style-type: none"> <li>Characteristic B</li> <li>Switching capacity 15 kA IEC</li> </ul>								
1	10	AWG 18	FAZ-B1/1-NA <sup>1)</sup> 132414		2 off 	FAZ-B1/2-NA <sup>1)</sup> 132693		1 off 
1.5	10	AWG 18	FAZ-B1,5/1-NA <sup>1)</sup> 132415			FAZ-B1,5/2-NA <sup>1)</sup> 132694		
2	10	AWG 18	FAZ-B2/1-NA <sup>1)</sup> 132416			FAZ-B2/2-NA <sup>1)</sup> 132695		
3	10	AWG 18	FAZ-B3/1-NA <sup>1)</sup> 132417			FAZ-B3/2-NA <sup>1)</sup> 132696		
4	10	AWG 18	FAZ-B4/1-NA <sup>1)</sup> 132418			FAZ-B4/2-NA <sup>1)</sup> 132697		
5	10	AWG 18	FAZ-B5/1-NA <sup>1)</sup> 132419			FAZ-B5/2-NA <sup>1)</sup> 132698		
6	10	AWG 18	FAZ-B6/1-NA <sup>1)</sup> 132680			FAZ-B6/2-NA <sup>1)</sup> 132699		
7	10	AWG 18	FAZ-B7/1-NA <sup>1)</sup> 132681			FAZ-B7/2-NA <sup>1)</sup> 132700		
8	10	AWG 16	FAZ-B8/1-NA <sup>1)</sup> 132682			FAZ-B8/2-NA <sup>1)</sup> 132701		
10	10	AWG 16	FAZ-B10/1-NA <sup>1)</sup> 132683			FAZ-B10/2-NA <sup>1)</sup> 132702		
13	10	-	FAZ-B13/1-NA <sup>1)</sup> 132684			FAZ-B13/2-NA <sup>1)</sup> 132703		
15	14	-	FAZ-B15/1-NA <sup>1)</sup> 132685			FAZ-B15/2-NA <sup>1)</sup> 132704		
16	14	-	FAZ-B16/1-NA <sup>1)</sup> 132686			FAZ-B16/2-NA <sup>1)</sup> 132705		
20	14	-	FAZ-B20/1-NA <sup>1)</sup> 132687			FAZ-B20/2-NA <sup>1)</sup> 132706		
25	14	-	FAZ-B25/1-NA <sup>1)</sup> 132688			FAZ-B25/2-NA <sup>1)</sup> 132707		
30	10	-	FAZ-B30/1-NA <sup>1)</sup> 132689			FAZ-B30/2-NA <sup>1)</sup> 132708		
32	10	-	FAZ-B32/1-NA <sup>1)</sup> 132690			FAZ-B32/2-NA <sup>1)</sup> 132709		
35	10	-	FAZ-B35/1-NA <sup>2)</sup> 132691			FAZ-B35/2-NA <sup>2)</sup> 132710		
40	10	-	FAZ-B40/1-NA <sup>2)</sup> 132692			FAZ-B40/2-NA <sup>2)</sup> 132711		

Rated operational current $I_n$ A	Interrupting capacity (SCCR) kA	Special approval for protection of AWG 18 or AWG 16 to NFPA70 (NEC) and NFPA 79	3 pole		Std. pack	Information relevant for export to North America 	Notes
			Part no. Article no.	Price See price list			
<b>Miniature circuit-breakers FAZ-NA</b>							
<ul style="list-style-type: none"> <li>Characteristic B</li> <li>Switching capacity 15 kA IEC</li> </ul>							
1	10	AWG 18	FAZ-B1/3-NA <sup>1)</sup> 132712		1 off 	<sup>1)</sup> Product Standards IEC/EN 60947-2; UL 489; CSA-C22.2 No. 5-09; CE marking E235139 UL CCN DIVQ CSA File No. 204453 CSA Class No. 1432-01 NA Certification UL Listed, CSA certified Suitable for Feeder circuits, branch circuits Current Limiting CB ✓ Max. Voltage Rating ≤ 32 A 1 pole: 277 V AC, 48 V DC 2 pole: 480 Y/277 V AC, 96 V DC 3 pole: 480 Y/277 V AC IEC: IP20, UL/CSA Type: -  Degree of Protection  <sup>2)</sup> Product Standards IEC/EN 60947-2; UL 489; CSA-C22.2 No. 5-09; CE marking E235139 UL CCN DIVQ CSA File No. 204453 CSA Class No. 1432-01 NA Certification UL Listed, CSA certified Suitable for Feeder circuits, branch circuits Current Limiting CB ✓ Max. Voltage Rating > 32 A 1 pole: 240 V AC, 48 V DC 2 pole: 240 V AC, 96 V DC 3 pole: 240 V AC IEC: IP20, UL/CSA Type: -  Degree of Protection  FAZ-NA can also be used where FAZ Supplementary Protectors to UL 1077 are sufficient.	Accessories → 19/40  1 pole Depth 75 mm Width 17.7 mm   2 pole Depth 75 mm Width 35.4 mm   3 pole Depth 75 mm Width 53.1 mm 
1.5	10	AWG 18	FAZ-B1,5/3-NA <sup>1)</sup> 132713				
2	10	AWG 18	FAZ-B2/3-NA <sup>1)</sup> 132714				
3	10	AWG 18	FAZ-B3/3-NA <sup>1)</sup> 132715				
4	10	AWG 18	FAZ-B4/3-NA <sup>1)</sup> 132716				
5	10	AWG 18	FAZ-B5/3-NA <sup>1)</sup> 132717				
6	10	AWG 18	FAZ-B6/3-NA <sup>1)</sup> 132718				
7	10	AWG 18	FAZ-B7/3-NA <sup>1)</sup> 132719				
8	10	AWG 16	FAZ-B8/3-NA <sup>1)</sup> 132720				
10	10	AWG 16	FAZ-B10/3-NA <sup>1)</sup> 132721				
13	10	-	FAZ-B13/3-NA <sup>1)</sup> 132722				
15	14	-	FAZ-B15/3-NA <sup>1)</sup> 132723				
16	14	-	FAZ-B16/3-NA <sup>1)</sup> 132724				
20	14	-	FAZ-B20/3-NA <sup>1)</sup> 132725				
25	14	-	FAZ-B25/3-NA <sup>1)</sup> 132726				
30	10	-	FAZ-B30/3-NA <sup>1)</sup> 132727				
32	10	-	FAZ-B32/3-NA <sup>1)</sup> 132728				
35	10	-	FAZ-B35/3-NA <sup>2)</sup> 132729				
40	10	-	FAZ-B40/3-NA <sup>2)</sup> 132730				



Rated operational current $I_n$ A	Interrupting capacity (SCCR) kA	Special approval for protection of AWG 18 or AWG 16 to NFPA70 (NEC) and NFPA 79	1 pole		Std. pack	2 pole		Std. pack
			Part no. Article no.	Price See price list		Part no. Article no.	Price See price list	
<b>Miniature circuit-breakers FAZ-NA</b>								
<ul style="list-style-type: none"> <li>Characteristic C</li> <li>Switching capacity 15 kA IEC</li> </ul>								
0.5	10	AWG 18	FAZ-C0,5/1-NA <sup>1)</sup> 102077		2 off	FAZ-C0,5/2-NA <sup>1)</sup> 102157		1 off
1	10	AWG 18	FAZ-C1/1-NA <sup>1)</sup> 102078			FAZ-C1/2-NA <sup>1)</sup> 102158		
1.5	10	AWG 18	FAZ-C0,5/1-NA <sup>1)</sup> 102079			FAZ-C1,5/2-NA <sup>1)</sup> 102159		
2	10	AWG 18	FAZ-C2/1-NA <sup>1)</sup> 102080			FAZ-C2/2-NA <sup>1)</sup> 102160		
3	10	AWG 18	FAZ-C3/1-NA <sup>1)</sup> 102081			FAZ-C3/2-NA <sup>1)</sup> 102161		
4	10	AWG 18	FAZ-C4/1-NA <sup>1)</sup> 102082			FAZ-C4/2-NA <sup>1)</sup> 102162		
5	10	AWG 18	FAZ-C5/1-NA <sup>1)</sup> 102083			FAZ-C5/2-NA <sup>1)</sup> 102163		
6	10	AWG 18	FAZ-C6/1-NA <sup>1)</sup> 102084			FAZ-C6/2-NA <sup>1)</sup> 102164		
7	10	AWG 18	FAZ-C7/1-NA <sup>1)</sup> 102085			FAZ-C7/2-NA <sup>1)</sup> 102165		
8	10	AWG 16	FAZ-C8/1-NA <sup>1)</sup> 102086			FAZ-C8/2-NA <sup>1)</sup> 102166		
10	10	AWG 16	FAZ-C10/1-NA <sup>1)</sup> 102087			FAZ-C10/2-NA <sup>1)</sup> 102167		
13	10	-	FAZ-C13/1-NA <sup>1)</sup> 102088			FAZ-C13/2-NA <sup>1)</sup> 102168		
15	14	-	FAZ-C15/1-NA <sup>1)</sup> 102089			FAZ-C15/2-NA <sup>1)</sup> 102169		
16	14	-	FAZ-C16/1-NA <sup>1)</sup> 102090			FAZ-C16/2-NA <sup>1)</sup> 102170		
20	14	-	FAZ-C20/1-NA <sup>1)</sup> 102091			FAZ-C20/2-NA <sup>1)</sup> 102171		
25	14	-	FAZ-C25/1-NA <sup>1)</sup> 102092			FAZ-C25/2-NA <sup>1)</sup> 102172		
30	10	-	FAZ-C30/1-NA <sup>1)</sup> 102093			FAZ-C30/2-NA <sup>1)</sup> 102173		
32	10	-	FAZ-C32/1-NA <sup>1)</sup> 102094			FAZ-C32/2-NA <sup>1)</sup> 102174		
35	10	-	FAZ-C35/1-NA <sup>2)</sup> 102095			FAZ-C35/2-NA <sup>2)</sup> 102175		
40	10	-	FAZ-C40/1-NA <sup>2)</sup> 102096			FAZ-C40/2-NA <sup>2)</sup> 102176		

3 pole Part no. Article no.	Price See price list	Std. pack	Information relevant for export to North America	Notes
FAZ-C0,5/3-NA <sup>1)</sup> 102237		1 off		
FAZ-C1/3-NA <sup>1)</sup> 102238				
FAZ-C1,5/3-NA <sup>1)</sup> 102239				
FAZ-C2/3-NA <sup>1)</sup> 102240				
FAZ-C3/3-NA <sup>1)</sup> 102241				
FAZ-C4/3-NA <sup>1)</sup> 102242				
FAZ-C5/3-NA <sup>1)</sup> 102243				
FAZ-C6/3-NA <sup>1)</sup> 102244				
FAZ-C7/3-NA <sup>1)</sup> 102245				
FAZ-C8/3-NA <sup>1)</sup> 102246				
FAZ-C10/3-NA <sup>1)</sup> 102247				
FAZ-C13/3-NA <sup>1)</sup> 102248				
FAZ-C15/3-NA <sup>1)</sup> 102249				
FAZ-C16/3-NA <sup>1)</sup> 102250				
FAZ-C20/3-NA <sup>1)</sup> 102251				
FAZ-C25/3-NA <sup>1)</sup> 102252				
FAZ-C30/3-NA <sup>1)</sup> 102253				
FAZ-C32/3-NA <sup>1)</sup> 102254				
FAZ-C35/3-NA <sup>2)</sup> 102255				
FAZ-C40/3-NA <sup>2)</sup> 102256				

WWW.TM2A.PT info@tm2a.pt

WWW.TM2A.PT info@tm2a.pt

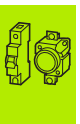

Rated operational current $I_n$ A	Interrupting capacity (SCCR) kA	Special approval for protection of AWG 18 or AWG 16 to NFPA70 (NEC) and NFPA 79	1 pole		Std. pack	2 pole		Std. pack
			Part no. Article no.	Price See price list		Part no. Article no.	Price See price list	
<b>Miniature circuit-breakers FAZ-NA</b>								
<ul style="list-style-type: none"> <li>Characteristic D</li> <li>Switching capacity 15 kA IEC</li> </ul>								
0.5	10	AWG 18	FAZ-D0,5/1-NA <sup>1)</sup> 102097		2 off 	FAZ-D0,5/2-NA <sup>1)</sup> 102177		1 off 
1	10	AWG 18	FAZ-D1/1-NA <sup>1)</sup> 102098			FAZ-D1/2-NA <sup>1)</sup> 102178		
1.5	10	AWG 18	FAZ-D0,5/1-NA <sup>1)</sup> 102099			FAZ-D1,5/2-NA <sup>1)</sup> 102179		
2	10	AWG 18	FAZ-D2/1-NA <sup>1)</sup> 102100			FAZ-D2/2-NA <sup>1)</sup> 102180		
3	10	AWG 18	FAZ-D3/1-NA <sup>1)</sup> 102101			FAZ-D3/2-NA <sup>1)</sup> 102181		
4	10	AWG 18	FAZ-D4/1-NA <sup>1)</sup> 102102			FAZ-D4/2-NA <sup>1)</sup> 102182		
5	10	AWG 18	FAZ-D5/1-NA <sup>1)</sup> 102103			FAZ-D5/2-NA <sup>1)</sup> 102183		
6	10	AWG 18	FAZ-D6/1-NA <sup>1)</sup> 102104			FAZ-D6/2-NA <sup>1)</sup> 102184		
7	10	AWG 18	FAZ-D7/1-NA <sup>1)</sup> 102105			FAZ-D7/2-NA <sup>1)</sup> 102185		
8	10	AWG 16	FAZ-D8/1-NA <sup>1)</sup> 102106			FAZ-D8/2-NA <sup>1)</sup> 102186		
10	10	AWG 16	FAZ-D10/1-NA <sup>1)</sup> 102107			FAZ-D10/2-NA <sup>1)</sup> 102187		
13	10	-	FAZ-D13/1-NA <sup>1)</sup> 102108			FAZ-D13/2-NA <sup>1)</sup> 102188		
15	14	-	FAZ-D15/1-NA <sup>1)</sup> 102109			FAZ-D15/2-NA <sup>1)</sup> 102189		
16	14	-	FAZ-D16/1-NA <sup>1)</sup> 102110			FAZ-D16/2-NA <sup>1)</sup> 102190		
20	14	-	FAZ-D20/1-NA <sup>1)</sup> 102111			FAZ-D20/2-NA <sup>1)</sup> 102191		
25	14	-	FAZ-D25/1-NA <sup>1)</sup> 102112			FAZ-D25/2-NA <sup>1)</sup> 102192		
30	10	-	FAZ-D30/1-NA <sup>1)</sup> 102113			FAZ-D30/2-NA <sup>1)</sup> 102193		
32	10	-	FAZ-D32/1-NA <sup>1)</sup> 102114			FAZ-D32/2-NA <sup>1)</sup> 102194		
35	10	-	FAZ-D35/1-NA <sup>2)</sup> 102115			FAZ-D35/2-NA <sup>2)</sup> 102195		
40	10	-	FAZ-D40/1-NA <sup>2)</sup> 102116			FAZ-D40/2-NA <sup>2)</sup> 102196		

3 pole Part no. Article no.	Price See price list	Std. pack		Information relevant for export to North America	Notes

FAZ-NA can also be used where FAZ Supplementary Protectors to UL 1077 are sufficient.

Rated operational current $I_n$ A	Interrupting capacity (SCCR) kA	Special approval for protection of AWG 18 or AWG 16 to NFPA70 (NEC) and NFPA 79	1 pole		Std. pack	2 pole		Std. pack
			Part no. Article no.	Price See price list		Part no. Article no.	Price See price list	
<b>Miniature circuit-breakers FAZ-RT</b>								
<ul style="list-style-type: none"> <li>With ring cable lug connection</li> <li>Characteristic B</li> <li>Switching capacity 15 kA IEC</li> </ul>								
1	10	AWG 18	FAZ-B1/1-RT <sup>(1)</sup> 132731		2 off 	FAZ-B1/2-RT <sup>(1)</sup> 132750		1 off 
1.5	10	AWG 18	FAZ-B1,5/1-RT <sup>(1)</sup> 132732			FAZ-B1,5/2-RT <sup>(1)</sup> 132751		
2	10	AWG 18	FAZ-B2/1-RT <sup>(1)</sup> 132733			FAZ-B2/2-RT <sup>(1)</sup> 132752		
3	10	AWG 18	FAZ-B3/1-RT <sup>(1)</sup> 132734			FAZ-B3/2-RT <sup>(1)</sup> 132753		
4	10	AWG 18	FAZ-B4/1-RT <sup>(1)</sup> 132735			FAZ-B4/2-RT <sup>(1)</sup> 132754		
5	10	AWG 18	FAZ-B5/1-RT <sup>(1)</sup> 132736			FAZ-B5/2-RT <sup>(1)</sup> 132755		
6	10	AWG 18	FAZ-B6/1-RT <sup>(1)</sup> 132737			FAZ-B6/2-RT <sup>(1)</sup> 132756		
7	10	AWG 18	FAZ-B7/1-RT <sup>(1)</sup> 132738			FAZ-B7/2-RT <sup>(1)</sup> 132757		
8	10	AWG 16	FAZ-B8/1-RT <sup>(1)</sup> 132739			FAZ-B8/2-RT <sup>(1)</sup> 132758		
10	10	AWG 16	FAZ-B10/1-RT <sup>(1)</sup> 132740			FAZ-B10/2-RT <sup>(1)</sup> 132759		
13	10	-	FAZ-B13/1-RT <sup>(1)</sup> 132741			FAZ-B13/2-RT <sup>(1)</sup> 132760		
15	14	-	FAZ-B15/1-RT <sup>(1)</sup> 132742			FAZ-B15/2-RT <sup>(1)</sup> 132761		
16	14	-	FAZ-B16/1-RT <sup>(1)</sup> 132743			FAZ-B16/2-RT <sup>(1)</sup> 132762		
20	14	-	FAZ-B20/1-RT <sup>(1)</sup> 132744			FAZ-B20/2-RT <sup>(1)</sup> 132763		
25	14	-	FAZ-B25/1-RT <sup>(1)</sup> 132745			FAZ-B25/2-RT <sup>(1)</sup> 132764		
30	10	-	FAZ-B30/1-RT <sup>(1)</sup> 132746			FAZ-B30/2-RT <sup>(1)</sup> 132765		
32	10	-	FAZ-B32/1-RT <sup>(1)</sup> 132747			FAZ-B32/2-RT <sup>(1)</sup> 132766		
35	10	-	FAZ-B35/1-RT <sup>(2)</sup> 132748			FAZ-B35/2-RT <sup>(2)</sup> 132767		
40	10	-	FAZ-B40/1-RT <sup>(2)</sup> 132749			FAZ-B40/2-RT <sup>(2)</sup> 132768		

3 pole	Part no. Article no.	Price See price list	Std. pack		Information relevant for export to North America	Notes
FAZ-B1/3-RT <sup>(1)</sup> 132769			1 off 		<p>UL File No. E235139</p> <p>UL CCN DIVQ</p> <p>CSA File No. 204453</p> <p>CSA Class No. 1432-01</p> <p>NA Certification UL Listed, CSA certified</p> <p>Suitable for Feeder circuits, branch circuits</p> <p>Current Limiting CB ✓</p> <p>Max. Voltage Rating ≤ 32 A</p> <p>1 pole: 277 V AC, 48 V DC</p> <p>2 pole: 480 Y/277 V AC, 96 V DC</p> <p>3 pole: 480 Y/277 V AC</p> <p>IEC: IP20, UL/CSA Type: -</p>	<p>Accessories → 19/40</p> <p>1 pole Depth 75 mm Width 17.7 mm</p> <p>2 pole Depth 75 mm Width 35.4 mm</p> <p>3 pole Depth 75 mm Width 53.1 mm</p>
FAZ-B1,5/3-RT <sup>(1)</sup> 132770					<p>FAZ-RT can also be used where FAZ Supplementary Protectors to UL 1077 are sufficient.</p>	
FAZ-B2/3-RT <sup>(1)</sup> 132771						
FAZ-B3/3-RT <sup>(1)</sup> 132772						
FAZ-B4/3-RT <sup>(1)</sup> 132773						
FAZ-B5/3-RT <sup>(1)</sup> 132774						
FAZ-B6/3-RT <sup>(1)</sup> 132775						
FAZ-B7/3-RT <sup>(1)</sup> 132776						
FAZ-B8/3-RT <sup>(1)</sup> 132777						
FAZ-B10/3-RT <sup>(1)</sup> 132778						
FAZ-B13/3-RT <sup>(1)</sup> 132779						
FAZ-B15/3-RT <sup>(1)</sup> 132780						
FAZ-B16/3-RT <sup>(1)</sup> 132781						
FAZ-B20/3-RT <sup>(1)</sup> 132782						
FAZ-B25/3-RT <sup>(1)</sup> 132783						
FAZ-B30/3-RT <sup>(1)</sup> 132784						
FAZ-B32/3-RT <sup>(1)</sup> 132785						
FAZ-B35/3-RT <sup>(2)</sup> 132786						
FAZ-B40/3-RT <sup>(2)</sup> 132787						

Rated operational current $I_n$ A	Interrupting capacity (SCCR) kA	Special approval for protection of AWG 18 or AWG 16 to NFPA70 (NEC) and NFPA 79	1 pole		Std. pack	2 pole		Std. pack
			Part no. Article no.	Price See price list		Part no. Article no.	Price See price list	
<b>Miniature circuit-breakers FAZ-RT</b>								
<ul style="list-style-type: none"> <li>With ring cable lug connection</li> <li>Characteristic C</li> <li>Switching capacity 15 kA IEC</li> </ul>								
0.5	10	AWG 18	FAZ-C0.5/1-RT <sup>(1)</sup> 102117		2 off 	FAZ-C0.5/2-RT <sup>(1)</sup> 102197		1 off 
1	10	AWG 18	FAZ-C1/1-RT <sup>(1)</sup> 102118			FAZ-C1/2-RT <sup>(1)</sup> 102198		
1.5	10	AWG 18	FAZ-C0.5/1-RT <sup>(1)</sup> 102119			FAZ-C1.5/2-RT <sup>(1)</sup> 102199		
2	10	AWG 18	FAZ-C2/1-RT <sup>(1)</sup> 102120			FAZ-C2/2-RT <sup>(1)</sup> 102200		
3	10	AWG 18	FAZ-C3/1-RT <sup>(1)</sup> 102121			FAZ-C3/2-RT <sup>(1)</sup> 102201		
4	10	AWG 18	FAZ-C4/1-RT <sup>(1)</sup> 102122			FAZ-C4/2-RT <sup>(1)</sup> 102202		
5	10	AWG 18	FAZ-C5/1-RT <sup>(1)</sup> 102123			FAZ-C5/2-RT <sup>(1)</sup> 102203		
6	10	AWG 18	FAZ-C6/1-RT <sup>(1)</sup> 102124			FAZ-C6/2-RT <sup>(1)</sup> 102204		
7	10	AWG 18	FAZ-C7/1-RT <sup>(1)</sup> 102125			FAZ-C7/2-RT <sup>(1)</sup> 102205		
8	10	AWG 16	FAZ-C8/1-RT <sup>(1)</sup> 102126			FAZ-C8/2-RT <sup>(1)</sup> 102206		
10	10	AWG 16	FAZ-C10/1-RT <sup>(1)</sup> 102127			FAZ-C10/2-RT <sup>(1)</sup> 102207		
13	10	-	FAZ-C13/1-RT <sup>(1)</sup> 102128			FAZ-C13/2-RT <sup>(1)</sup> 102208		
15	14	-	FAZ-C15/1-RT <sup>(1)</sup> 102129			FAZ-C15/2-RT <sup>(1)</sup> 102209		
16	14	-	FAZ-C16/1-RT <sup>(1)</sup> 102130			FAZ-C16/2-RT <sup>(1)</sup> 102210		
20	14	-	FAZ-C20/1-RT <sup>(1)</sup> 102131			FAZ-C20/2-RT <sup>(1)</sup> 102211		
25	14	-	FAZ-C25/1-RT <sup>(1)</sup> 102132			FAZ-C25/2-RT <sup>(1)</sup> 102212		
30	10	-	FAZ-C30/1-RT <sup>(1)</sup> 102133			FAZ-C30/2-RT <sup>(1)</sup> 102213		
32	10	-	FAZ-C32/1-RT <sup>(1)</sup> 102134			FAZ-C32/2-RT <sup>(1)</sup> 102214		
35	10	-	FAZ-C35/1-RT <sup>(2)</sup> 102135			FAZ-C35/2-RT <sup>(2)</sup> 102215		
40	10	-	FAZ-C40/1-RT <sup>(2)</sup> 102136			FAZ-C40/2-RT <sup>(2)</sup> 102216		

Rated operational current $I_n$ A	Interrupting capacity (SCCR) kA	Special approval for protection of AWG 18 or AWG 16 to NFPA70 (NEC) and NFPA 79	3 pole		Std. pack	Information relevant for export to North America 	Notes
			Part no. Article no.	Price See price list			
<b>Miniature circuit-breakers FAZ-RT</b>							
<ul style="list-style-type: none"> <li>With ring cable lug connection</li> <li>Characteristic C</li> <li>Switching capacity 15 kA IEC</li> </ul>							
0.5	10	AWG 18	FAZ-C0.5/3-RT <sup>(1)</sup> 102277		1 off 	<sup>1)</sup> Product Standards IEC/EN 60947-2; UL 489; CSA-C22.2 No. 5-09; CE marking UL File No. E235139 UL CCN DIVQ CSA File No. 204453 CSA Class No. 1432-01 NA Certification UL Listed, CSA certified Suitable for Feeder circuits, branch circuits Current Limiting CB ✓ Max. Voltage Rating ≤ 32 A 1 pole: 277 V AC, 48 V DC 2 pole: 480 Y/277 V AC, 96 V DC 3 pole: 480 Y/277 V AC IEC: IP20, UL/CSA Type: -	Accessories → 19/40  1 pole Depth 75 mm Width 17.7 mm 
1	10	AWG 18	FAZ-C1/3-RT <sup>(1)</sup> 102278			<sup>2)</sup> Product Standards IEC/EN 60947-2; UL 489; CSA-C22.2 No. 5-09; CE marking UL File No. E235139 UL CCN DIVQ CSA File No. 204453 CSA Class No. 1432-01 NA Certification UL Listed, CSA certified Suitable for Feeder circuits, branch circuits Current Limiting CB ✓ Max. Voltage Rating > 32 A 1 pole: 240 V AC, 48 V DC 2 pole: 240 V AC, 96 V DC 3 pole: 240 V AC IEC: IP20, UL/CSA Type: -	2 pole Depth 75 mm Width 35.4 mm 
1.5	10	AWG 18	FAZ-C1.5/3-RT <sup>(1)</sup> 102279			Degree of Protection  FAZ-RT can also be used where FAZ Supplementary Protectors to UL 1077 are sufficient.	3 pole Depth 75 mm Width 53.1 mm 
2	10	AWG 18	FAZ-C2/3-RT <sup>(1)</sup> 102280				
3	10	AWG 18	FAZ-C3/3-RT <sup>(1)</sup> 102281				
4	10	AWG 18	FAZ-C4/3-RT <sup>(1)</sup> 102282				
5	10	AWG 18	FAZ-C5/3-RT <sup>(1)</sup> 102283				
6	10	AWG 18	FAZ-C6/3-RT <sup>(1)</sup> 102284				
7	10	AWG 18	FAZ-C7/3-RT <sup>(1)</sup> 102285				
8	10	AWG 16	FAZ-C8/3-RT <sup>(1)</sup> 102286				
10	10	AWG 16	FAZ-C10/3-RT <sup>(1)</sup> 102287				
13	10	-	FAZ-C13/3-RT <sup>(1)</sup> 102288				
15	14	-	FAZ-C15/3-RT <sup>(1)</sup> 102289				
16	14	-	FAZ-C16/3-RT <sup>(1)</sup> 102290				
20	14	-	FAZ-C20/3-RT <sup>(1)</sup> 102291				
25	14	-	FAZ-C25/3-RT <sup>(1)</sup> 102292				
30	10	-	FAZ-C30/3-RT <sup>(1)</sup> 102293				
32	10	-	FAZ-C32/3-RT <sup>(1)</sup> 102294				
35	10	-	FAZ-C35/3-RT <sup>(2)</sup> 102295				
40	10	-	FAZ-C40/3-RT <sup>(2)</sup> 102296				











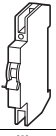
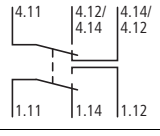

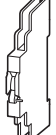
WWW.TM2A.PT info@tm2a.pt

WWW.TM2A.PT info@tm2a.pt

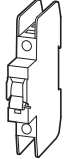
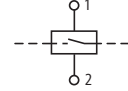
Rated operational current $I_n$ A	Interrupting capacity (SCCR) kA	Special approval for protection of AWG 18 or AWG 16 to NFPA70 (NEC) and NFPA 79	1 pole		Std. pack	2 pole		Std. pack
			Part no. Article no.	Price See price list		Part no. Article no.	Price See price list	
<b>Miniature circuit-breakers FAZ-RT</b>								
<ul style="list-style-type: none"> <li>With ring cable lug connection</li> <li>Characteristic D</li> <li>Switching capacity 15 kA IEC</li> </ul>								
0.5	10	AWG 18	FAZ-D0,5/1-RT <sup>(1)</sup> 102137		2 off 	FAZ-D0,5/2-RT <sup>(1)</sup> 102217		1 off 
1	10	AWG 18	FAZ-D1/1-RT <sup>(1)</sup> 102138			FAZ-D1/2-RT <sup>(1)</sup> 102218		
1.5	10	AWG 18	FAZ-D0,5/1-RT <sup>(1)</sup> 102139			FAZ-D1,5/2-RT <sup>(1)</sup> 102219		
2	10	AWG 18	FAZ-D2/1-RT <sup>(1)</sup> 102140			FAZ-D2/2-RT <sup>(1)</sup> 102220		
3	10	AWG 18	FAZ-D3/1-RT <sup>(1)</sup> 102141			FAZ-D3/2-RT <sup>(1)</sup> 102221		
4	10	AWG 18	FAZ-D4/1-RT <sup>(1)</sup> 102142			FAZ-D4/2-RT <sup>(1)</sup> 102222		
5	10	AWG 18	FAZ-D5/1-RT <sup>(1)</sup> 102143			FAZ-D5/2-RT <sup>(1)</sup> 102223		
6	10	AWG 18	FAZ-D6/1-RT <sup>(1)</sup> 102144			FAZ-D6/2-RT <sup>(1)</sup> 102224		
7	10	AWG 18	FAZ-D7/1-RT <sup>(1)</sup> 102145			FAZ-D7/2-RT <sup>(1)</sup> 102225		
8	10	AWG 16	FAZ-D8/1-RT <sup>(1)</sup> 102146			FAZ-D8/2-RT <sup>(1)</sup> 102226		
10	10	AWG 16	FAZ-D10/1-RT <sup>(1)</sup> 102147			FAZ-D10/2-RT <sup>(1)</sup> 102227		
13	10	-	FAZ-D13/1-RT <sup>(1)</sup> 102148			FAZ-D13/2-RT <sup>(1)</sup> 102228		
15	14	-	FAZ-D15/1-RT <sup>(1)</sup> 102149			FAZ-D15/2-RT <sup>(1)</sup> 102229		
16	14	-	FAZ-D16/1-RT <sup>(1)</sup> 102150			FAZ-D16/2-RT <sup>(1)</sup> 102230		
20	14	-	FAZ-D20/1-RT <sup>(1)</sup> 102151			FAZ-D20/2-RT <sup>(1)</sup> 102231		
25	14	-	FAZ-D25/1-RT <sup>(1)</sup> 102152			FAZ-D25/2-RT <sup>(1)</sup> 102232		
30	10	-	FAZ-D30/1-RT <sup>(1)</sup> 102153			FAZ-D30/2-RT <sup>(1)</sup> 102233		
32	10	-	FAZ-D32/1-RT <sup>(1)</sup> 102154			FAZ-D32/2-RT <sup>(1)</sup> 102234		
35	10	-	FAZ-D35/1-RT <sup>(2)</sup> 102155			FAZ-D35/2-RT <sup>(2)</sup> 102235		
40	10	-	FAZ-D40/1-RT <sup>(2)</sup> 102156			FAZ-D40/2-RT <sup>(2)</sup> 102236		

3 pole Part no. Article no.	Price See price list	Std. pack		Information relevant for export to North America	Notes
FAZ-D0,5/3-RT <sup>(1)</sup> 102297		1 off 			
FAZ-D1/3-RT <sup>(1)</sup> 102298					
FAZ-D1,5/3-RT <sup>(1)</sup> 102299					
FAZ-D2/3-RT <sup>(1)</sup> 102300					
FAZ-D3/3-RT <sup>(1)</sup> 102301					
FAZ-D4/3-RT <sup>(1)</sup> 102302					
FAZ-D5/3-RT <sup>(1)</sup> 102303					
FAZ-D6/3-RT <sup>(1)</sup> 102304					
FAZ-D7/3-RT <sup>(1)</sup> 102305					
FAZ-D8/3-RT <sup>(1)</sup> 102306					
FAZ-D10/3-RT <sup>(1)</sup> 102307					
FAZ-D13/3-RT <sup>(1)</sup> 102308					
FAZ-D15/3-RT <sup>(1)</sup> 102309					
FAZ-D16/3-RT <sup>(1)</sup> 102310					
FAZ-D20/3-RT <sup>(1)</sup> 102311					
FAZ-D25/3-RT <sup>(1)</sup> 102312					
FAZ-D30/3-RT <sup>(1)</sup> 102313					
FAZ-D32/3-RT <sup>(1)</sup> 102314					
FAZ-D35/3-RT <sup>(2)</sup> 102315					
FAZ-D40/3-RT <sup>(2)</sup> 102316					



Contacts	Contact sequences	Space units 1 PLE = 18 mm	For use with	Part no. Article no.	Price See price list	Std. pack
<p>C = Changeover contact N/O = normally open contact NC = normally closed contact</p>						
<b>Accessories for FAZ-NA, FAZ-RT</b>						
<p>Tripping signal contact</p> <ul style="list-style-type: none"> <li>The function of one of the two changeover contacts can be changed from "auxiliary contact" to "tripping signal contact".</li> </ul>						
	2 C		0.5	FAZ-NA FAZ-RT	<b>Z-NHK</b> 248434	4 off  
<p>Auxiliary contacts</p> <ul style="list-style-type: none"> <li>Suitable for FAZ-NA &gt; 480V/277 V AC</li> </ul>						
	1 N/O 1 NC		0.5	FAZ-NA FAZ-RT	<b>Z-IHK-NA</b> 113895	1 off  
<p>Shunt releases</p> <ul style="list-style-type: none"> <li>Standard auxiliary contacts can be fitted in addition</li> <li>Position indicator red/green</li> </ul>						
	-		1	FAZ-NA FAZ-RT	<b>FAZ-XAA-NA110-415VAC</b> 102036	1 off  
	-		1	FAZ-NA FAZ-RT	<b>FAZ-XAA-NA12-110VAC</b> 102037	1 off  

Information relevant for export to North America





Product Standards	IEC/EN 60898; UL 489; CSA-C22.2 No. 5-09; CE marking
UL File No.	E257181
UL CCN	DIHS, DIHS7
CSA File No.	204453
CSA Class No.	1437-01
NA Certification	UL Listed, CSA certified
Degree of Protection	IEC: IP20, UL/CSA Type: -

WWW.TM2A.PT info@tm2a.pt

WWW.TM2A.PT info@tm2a.pt



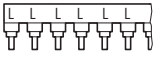

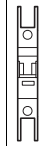
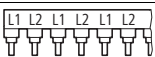
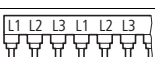

HPL19041EN

Phases Number	Devices Number	Part no. Article no.	Price See price list	Std. pack	Notes
<b>Accessories for FAZ-NA, FAZ-RT</b>					
Busbars (pin), UL 489 <ul style="list-style-type: none"> <li>• 16 mm<sup>2</sup></li> <li>• Rated operational current 80 A</li> <li>• For FAZ-NA, FAZ-RT</li> <li>• Do not shorten</li> </ul>					
	1	6	<b>Z-SV/UL-16/1P-1TE/6</b> 104892	10 off 	
	1	12	<b>Z-SV/UL-16/1P-1TE/12</b> 104893		
	1	18	<b>Z-SV/UL-16/1P-1TE/18</b> 104894		
	2	6	<b>Z-SV/UL-16/2P-2TE/6</b> 104895		
	2	12	<b>Z-SV/UL-16/2P-2TE/12</b> 104896		
	2	18	<b>Z-SV/UL-16/2P-2TE/18</b> 104897		
	3	6	<b>Z-SV/UL-16/3P-3TE/6</b> 104898		
	3	12	<b>Z-SV/UL-16/3P-3TE/12</b> 104899		
	3	18	<b>Z-SV/UL-16/3P-3TE/18</b> 104900		

**Information relevant for export to North America**

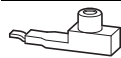

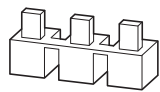



Product Standards	IEC/EN 60898; UL 489; CE marking
UL File No.	E257181
UL CCN	NMTR2, DIHS2
CSA File No.	-
CSA Class No.	-
NA Certification	UL Recognized
Suitable for	Feeder Circuit, Branch Circuit
Max. Voltage Rating	Refer to main components FAZ, FAZ-NA, FAZ-RT
Degree of Protection	IEC: IP20, UL/CSA Type: -

For use with	Part no. Article no.	Price See price list	Std. pack	Information relevant for export to North America
<b>Accessories for FAZ-NA, FAZ-RT</b>				
Connecting bracket <ul style="list-style-type: none"> <li>• 2.5 - 35 mm<sup>2</sup>, AWG 14-2</li> <li>• UL 489</li> </ul>				
	FAZ-NA FAZ-RT	<b>Z-EK/35/UL</b> 104901	3 off 	Product Standards IEC/EN 60898; UL 489; CE marking UL File No. E257181 UL CCN NMTR2, DIHS2 CSA File No. - CSA Class No. - NA Certification UL Recognized Suitable for Feeder circuits, branch circuits Max. Voltage Rating Refer to main components FAZ, FAZ-NA, FAZ-RT Degree of Protection IEC: IP20, UL/CSA Type: -
Busbar cover <ul style="list-style-type: none"> <li>• for 3 pins</li> <li>• UL 489</li> </ul>				
	FAZ-NA FAZ-RT	<b>ZV-BS-UL</b> 104904	10 off 	Product Standards IEC/EN 60898; UL 489; CE marking UL File No. E257181 UL CCN NMTR2, DIHS2 CSA File No. - CSA Class No. - NA Certification UL Recognized Degree of Protection IEC: IP20, UL/CSA Type: -

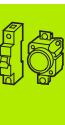
WWW.TM2A.PT info@tm2a.pt

WWW.TM2A.PT info@tm2a.pt

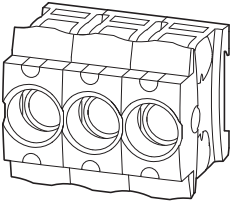

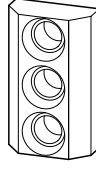
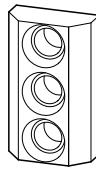
	Pole	Rated operational current $I_e$ A	Rated operational voltage $U_e$ V AC	Fuse-link  Size	Part no. Article no.	Price See price list	Std. pack	Notes	
<b>Fuse bases</b>									
	1 pole	16	–	D01	<b>D01-S0/16/1</b> 102752		9 off	Equipment supplied: Empty, without screw on cover	
	1 pole	63	–	D02	<b>D02-S0/63/1</b> 102675		9 off		
	3 pole	16	–	D01	<b>D01-S0/16/3</b> 102674		3 off		
	3 pole	63	–	D02	<b>D02-S0/63/3</b> 102676		3 off		
<b>Fuse bases, 1 pole</b>									
For gauge ring system (gauge screw: /FORMP)									
Screw fixing (holes for M4 screws)									
	1 pole	25	500	E27, DII	<b>S27-1</b> 045865		10 off	Gauge rings/gauge screws, fuse links and fuse caps are <b>not</b> included.	
		25	500	E27, DII	<b>S27-1/FORMP</b> 020327		10 off		
		63	660 690	E33, DIII	<b>S33-1</b> 069595		2 off		
		63	660 690	E33, DIII	<b>S33-1/FORMP</b> 022700		2 off		
Can be snap fitted on top-hat rail to IEC/EN 60715 (35 mm)									
	1 pole	25	500	E27, DII	<b>S27-1/C</b> 048238		20 off		
		25	500	E27, DII	<b>S27-1/C/FORMP</b> 025073		20 off		
		63	660 690	E33, DIII	<b>S33-1/C</b> 071968		2 off		
		63	660 690	E33, DIII	<b>S33-1/C/FORMP</b> 027446		2 off		
<b>Fuse bases, 3 pole</b>									
For gauge ring system (gauge screw: /FORMP)									
Screw fixing (holes for M4 screws)									
	3 pole	25	500	E27, DII	<b>S27</b> 043492		4 off	Gauge rings/gauge screws, fuse links and fuse caps are <b>not</b> included.	
		25	500	E27, DII	<b>S27/FORMP</b> 034565		4 off		
		63	660 690	E33, DIII	<b>S33</b> 067222		2 off		
		63	660 690	E33, DIII	<b>S33/FORMP</b> 036938		2 off		
Can be snap fitted on top-hat rail to IEC/EN 60715 (35 mm)									
	3 pole	25	500	E27, DII	<b>S27/C</b> 050611		4 off		
		25	500	E27, DII	<b>S27/C/FORMP</b> 032192		4 off		
		63	660 690	E33, DIII	<b>S33/C</b> 081460		2 off		
		63	660 690	E33, DIII	<b>S33/C/FORMP</b> 029819		2 off		



WWW.TM2A.PT info@tm2a.pt

WWW.TM2A.PT info@tm2a.pt

WWW.TM2A.PT info@tm2a.pt

WWW.TM2A.PT info@tm2a.pt

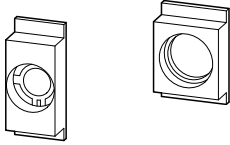
HPL19043EN



	For use with	Part no. Article no.	Price See price list	Std. pack
<b>Covers for 1 pole fuse bases</b>				
Standard front dimension 45 mm				
	S...-1/...	<b>P-E27</b> 090928		10 off
	S...-1/...	<b>P-E33</b> 093301		10 off
<b>Transparent shroud</b>				
With cable entry knockouts top and bottom	-	<b>H-S27-1</b> 029118		10 off
<b>Busbar connector 63 A</b>				
For fuse bases, 3 pole	D0.../3	<b>Z-SV-16/3P</b> 271072		20 off
<b>End cap</b>				
For busbar block	Z-SV-16/3P	<b>Z-AK-16/2+3P</b> 271070		10 off
<b>Notched phase busbars, can be cut to desired length</b>				
For gauge ring system (gauge screw: /FORMP)				
980 mm long, for max. 22 fuse bases, Rated operational current 100 A	S27-1/C	<b>KS27</b> 055248		5 off
960 mm long, for max. 18 fuse bases, rated operational current 160 A	S33-1/C	<b>KS33</b> 059994		5 off
<b>Terminal</b>				
	For gauge ring system (gauge screw: /FORMP)	KS14 - KS33	<b>K35-AB</b> 064339	20 off
	For round conductor up to 35 mm <sup>2</sup> or flat cable conductor 6 x 9 x 0.8			

	Rated operational current $I_e$ A	Fuse-link Size	Part no. Article no. Utilization category gG (gL)	Price See price list	Part no. Article no. Utilization category DZ	Price See price list	Std. pack
<b>Fuse links Z-D.../SE</b>							
Rated operating voltage 500 V AC/400 V DC							
	2	DII E27	<b>Z-DII/SE-2A/GG</b> 112125		<b>Z-DII/SE-2A/DZ</b> 112028		5 off
	4	DII E27	<b>Z-DII/SE-4A/GG</b> 112126		<b>Z-DII/SE-4A/DZ</b> 112029		
	6	DII E27	<b>Z-DII/SE-6A/GG</b> 112127		<b>Z-DII/SE-6A/DZ</b> 112120		
	10	DII E27	<b>Z-DII/SE-10A/GG</b> 112128		<b>Z-DII/SE-10A/DZ</b> 112121		
	16	DII E27	<b>Z-DII/SE-16A/GG</b> 112129		<b>Z-DII/SE-16A/DZ</b> 112122		
	20	DII E27	<b>Z-DII/SE-20A/GG</b> 112130		<b>Z-DII/SE-20A/DZ</b> 112123		
	25	DII E27	<b>Z-DII/SE-25A/GG</b> 112131		<b>Z-DII/SE-25A/DZ</b> 112124		
	35	DIII E33	<b>Z-DIII/SE-35A/GG</b> 112135		<b>Z-DIII/SE-35A/DZ</b> 112132		
	50	DIII E33	<b>Z-DIII/SE-50A/GG</b> 112136		<b>Z-DIII/SE-50A/DZ</b> 112133		
	63	DIII E33	<b>Z-DIII/SE-63A/GG</b> 112137		<b>Z-DIII/SE-63A/DZ</b> 112134		

WWW.TM2A.PT info@tm2a.pt

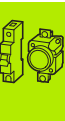
WWW.TM2A.PT info@tm2a.pt



	Rated operational current $I_e$ A	Rated operational voltage $U_e$ V AC	Fuse link  Size	Part no. Article no.	Price See price list	Std. pack		
<b>Gauge screws Z-DII.../PS</b>								
	2	–	DII E27	<b>Z-DII/PS-2A</b> 112138		25 off		
	4	–	DII E27	<b>Z-DII/PS-4A</b> 112139				
	6	–	DII E27	<b>Z-DII/PS-6A</b> 112140				
	10	–	DII E27	<b>Z-DII/PS-10A</b> 112141				
	16	–	DII E27	<b>Z-DII/PS-16A</b> 112142				
	20	–	DII E27	<b>Z-DII/PS-20A</b> 112143				
	25	–	DII E27	<b>Z-DII/PS-25A</b> 112144				
	35	–	DIII E33	<b>Z-DIII/PS-35A</b> 112145				
	50	–	DIII E33	<b>Z-DIII/PS-50A</b> 112146				
	63	–	DIII E33	<b>Z-DIII/PS-63A</b> 112147				
<b>Z-DII.../PE push-in gauge rings</b>								
	2	–	DII E27	<b>Z-DII/PE-2A</b> 110396		50 off		
	4	–	DII E27	<b>Z-DII/PE-4A</b> 110397				
	6	–	DII E27	<b>Z-DII/PE-6A</b> 110398				
	10	–	DII E27	<b>Z-DII/PE-10A</b> 110399				
	16	–	DII E27	<b>Z-DII/PE-16A</b> 110790				
	20	–	DII E27	<b>Z-DII/PE-20A</b> 110791				
	2	–	DIII E33	<b>Z-DIII/PE-2A</b> 110792				
	4	–	DIII E33	<b>Z-DIII/PE-4A</b> 110793				
	6	–	DIII E33	<b>Z-DIII/PE-6A</b> 110794				
	10	–	DIII E33	<b>Z-DIII/PE-10A</b> 110795				
	16	–	DIII E33	<b>Z-DIII/PE-16A</b> 110796				
	20	–	DIII E33	<b>Z-DIII/PE-20A</b> 110797				
	25	–	DIII E33	<b>Z-DIII/PE-25A</b> 110798				
	35	–	DIII E33	<b>Z-DIII/PE-35A</b> 110799				
	50	–	DIII E33	<b>Z-DIII/PE-50A</b> 110800				
	<b>Z-DII.../SK screw caps</b>							
		–	500	DII E27	<b>Z-DII/SK</b> 112148			50 off
		–	500	DIII E33	<b>Z-DIII/SK</b> 112149			30 off
		–	690	DIII E33	<b>Z-DIII/SK-690</b> 118904			3 off

HPL19045EN

**Z-SLS**

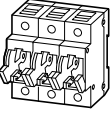
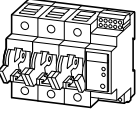
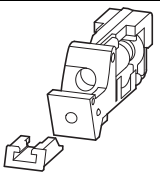
	Pole	Rated uninterrupted current $I_u$ A	Fuse link  Size	Part no. Article no.	Price See price list	Std. pack
<b>Fuse switch-disconnectors</b>						
 <p>Standard, empty</p>	1	63	D02, D01	<b>Z-SLS/NE0Z/1</b> 248235		12 off
	1 + N			<b>Z-SLS/NE0Z/1+N</b> 248237		6 off
	2			<b>Z-SLS/NE0Z/2</b> 248233		6 off
	3			<b>Z-SLS/NE0Z/3</b> 248234		4 off
	3 + N			<b>Z-SLS/NE0Z/3+N</b> 248236		3 off
 <p>With fuse monitoring, empty</p>	1 + HS			<b>Z-SLK/NE0Z/1</b> 248238		6 off
	1 + N + HS			<b>Z-SLK/NE0Z/1+N</b> 248242		4 off
	2 + HS			<b>Z-SLK/NE0Z/2</b> 248239		4 off
	3 + HS			<b>Z-SLK/NE0Z/3</b> 248240		3 off
	3 + N + HS			<b>Z-SLK/NE0Z/3+N</b> 248241		2 off
<b>Fuse sets</b>						
<ul style="list-style-type: none"> <li>• For Z-SLS/NE0Z, Z-SLK/NE0Z, Z-SLS/CEK</li> <li>• With flashing function</li> <li>• Snap-fit on DIN rail</li> <li>• 1 set consists of: 3 fuse links, 3 current codings, 1 plastic box in the color of the indicator</li> </ul>						
	Rated operational voltage 24 V AC/DC	1	–	<b>Z-SLS/B-24-1A</b> 268994		12 off
		2	–	<b>Z-SLS/B-24-2A</b> 268995		
		4	–	<b>Z-SLS/B-24-4A</b> 268996		
		6	–	<b>Z-SLS/B/24-6A</b> 268997		
		10	–	<b>Z-SLS/B/24-10A</b> 268998		
		13	–	<b>Z-SLS/B/24-13A</b> 289975		
		16	–	<b>Z-SLS/B/24-16A</b> 268999		
		20	–	<b>Z-SLS/B/24-20A</b> 269000		
		25	–	<b>Z-SLS/B/24-25A</b> 269001		
		32	–	<b>Z-SLS/B/24-32A</b> 289976		
		35	–	<b>Z-SLS/B/24-35A</b> 269002		
		40	–	<b>Z-SLS/B/24-40A</b> 289977		
		50	–	<b>Z-SLS/B/24-50A</b> 269003		
		63	–	<b>Z-SLS/B/24-63A</b> 269004		



WWW.TM2A.PT info@tm2a.pt

WWW.TM2A.PT info@tm2a.pt



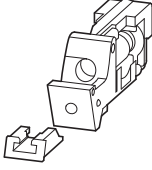
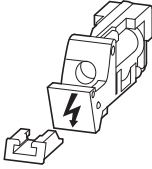
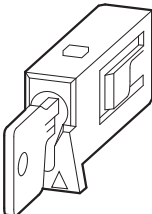
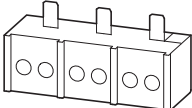

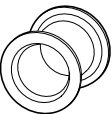
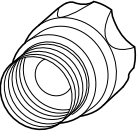

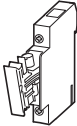
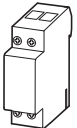

		Rated uninterrupted current $I_u$ A	Part no. Article no.	Price See price list	Std. pack
<b>Fuse sets</b>					
	Rated operational voltage 60 - 400 V AC	1	<b>Z-SLS/B-1A</b> 268983		12 off
		2	<b>Z-SLS/B-2A</b> 268984		
		4	<b>Z-SLS/B-4A</b> 268985		
		6	<b>Z-SLS/B-6A</b> 268986		
		10	<b>Z-SLS/B-10A</b> 268987		
		13	<b>Z-SLS/B-13A</b> 289972		
		16	<b>Z-SLS/B-16A</b> 268988		
		20	<b>Z-SLS/B-20A</b> 268989		
		25	<b>Z-SLS/B-25A</b> 268990		
		32	<b>Z-SLS/B-32A</b> 289973		
		35	<b>Z-SLS/B-35A</b> 268991		
		40	<b>Z-SLS/B-40A</b> 289974		
		60	<b>Z-SLS/B-50A</b> 268992		
		63	<b>Z-SLS/B-63A</b> 268993		
<b>Disconnecter kit</b>					
<ul style="list-style-type: none"> <li>For Z-SLS/NEOZ, Z-SLK/NEOZ, Z-SLS/CEK</li> <li>Snap-fit on DIN rail</li> <li>1 set consists of: 3 switch conversion sets, 3 current codings, 1 plastic box</li> <li>The fuse switch-disconnector is thus converted to a switch-disconnector.</li> </ul>					
	-	63	<b>Z-SLS/TR-SET</b> 100660		12 off
<b>Switch-on inhibits</b>					
<ul style="list-style-type: none"> <li>For Z-SLS/NEOZ, Z-SLK/NEOZ, Z-SLS/CEK, Z-SLK/D0</li> <li>Only 1 inhibit required per device</li> </ul>					
	Stop with metal lock	-	<b>Z-SLZ/SC</b> 268980		12 off
	Stop with plastic lock	-	<b>Z-SLZ/SP</b> 268981		12 off
<b>Incoming double terminal</b>					
<ul style="list-style-type: none"> <li>For Z-SLS/NEOZ, Z-SLK/NEOZ, Z-SLS/CEK, Z-SLK/D0</li> <li>2 x 3 x 35 mm<sup>2</sup></li> </ul>					
	-	-	<b>Z-SLZ/KL</b> 268982		15 off

	Rated uninterrupted current $I_u$ A	Fuse link Size	Part no. Article no.	Price See price list	Std. pack			
<b>Fuse links utilization category gG (gL)</b>								
 <ul style="list-style-type: none"> <li>• Snap-fit on DIN rail</li> <li>• In a plastic box in the color of the indicator</li> </ul>	2	D01	Z-D01/SE-2 288934		12 off			
	4		Z-D01/SE-4 288935					
	6		Z-D01/SE-6 288936					
	10		Z-D01/SE-10 288937					
	13		Z-D01/SE-13 288938					
	16		Z-D01/SE-16 288939					
	20		Z-D02/SE-20 288940					
	25		Z-D02/SE-25 288941					
	32		Z-D02/SE-32 288942					
	35		Z-D02/SE-35 288943					
	40		Z-D02/SE-40 288944					
	50		Z-D02/SE-50 288945					
	63		Z-D02/SE-63 288946					
	<b>Adapter sleeves</b>							
 <ul style="list-style-type: none"> <li>• Snap-fit on DIN rail</li> <li>• In a plastic box in the color of the indicator</li> </ul>	2	D01	Z-D01/PE-2 288909		12 off			
	4		Z-D01/PE-4 288910					
	6		Z-D01/PE-6 288911					
	10, 13		Z-D01/PE-10 288912					
	20		Z-D02/PE-20 288913					
	25		Z-D02/PE-25 288914					
	35, 32		Z-D02/PE-35 288915					
	40		Z-D02/PE-40 288916					
	50		Z-D02/PE-50 288917					
	<ul style="list-style-type: none"> <li>• D01 for fuse base D02 and fuse switch-disconnector D02</li> </ul>		2			D02-D01	Z-D02-D01/PE-2 263112	
		4	Z-D02-D01/PE-4 263113					
		6	Z-D02-D01/PE-6 263150					
		10, 13	Z-D02-D01/PE-10 263151					
		16	Z-D02-D01/PE-16 263152					
	<b>Screw caps</b>							
		Max. 16	D01			Z-D01/SK 100650		20 off
Max. 63		D02	Z-D02/SK 100651		20 off			
<b>Retaining spring</b>								
 <ul style="list-style-type: none"> <li>• For inserting D01 fuses links in the screw cap Z-D02/SK</li> </ul>		D02-D01	Z-D02/SIKA-HF 263149		50 off			





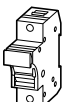



		Pole	Part no. Article no.	Price See price list	Std. pack
<b>Fuse switch-disconnectors (empty)</b>					
<ul style="list-style-type: none"> <li>Line protection of photovoltaic generator</li> <li>The trip indication signals that a fuse link has tripped:               <ul style="list-style-type: none"> <li>– 50 - 400 V flashing</li> <li>– 400 - 1000 V continuous light</li> </ul> </li> <li>Rated operational voltage 1000 V DC</li> <li>Size 10 x 38, rated operational current 20 A DC</li> <li>For cylindrical fuse links for photovoltaic applications</li> <li>Sealable</li> </ul>					
	Without flashing function	1	<b>C10-FD/20/1</b> 119024		12 off
	Without flashing function	2	<b>C10-FD/20/2</b> 119025		6 off
	With flashing function	1	<b>C10-FD/20/1-L</b> 119026		12 off
	With flashing function	2	<b>C10-FD/20/2-L</b> 119027		6 off

	Size	Rated operational current $I_e$ A	Rated operating voltage $U_e$ V DC	Part no. Article no.	Price See price list	Std. pack
<b>Cylindrical fuse links Z-C.../SE for photovoltaic applications</b>						
<ul style="list-style-type: none"> <li>Maximum DC rated operating voltage of fuse link <math>1.2 \times V_{cc}</math> of line (<math>V_{cc}</math> ... open circuit voltage of line)</li> <li>Rated operational current <math>I_n</math> of Fuse link must be greater than or equal to <math>1.5 \times I_{sc}</math> (<math>I_{sc}</math> ... short circuit current of PV module)</li> </ul>						
	10 x 38	2	1000	<b>Z-C10/SE-2A/PV</b> 131700		10 off
	10 x 38	4	1000	<b>Z-C10/SE-4A/PV</b> 131701		
	10 x 38	6	1000	<b>Z-C10/SE-6A/PV</b> 122009		
	10 x 38	8	1000	<b>Z-C10/SE-8A/PV</b> 122070		
	10 x 38	10	1000	<b>Z-C10/SE-10A/PV</b> 122071		
	10 x 38	12	1000	<b>Z-C10/SE-12A/PV</b> 131702		
	10 x 38	16	1000	<b>Z-C10/SE-16A/PV</b> 122072		
	10 x 38	20	1000	<b>Z-C10/SE-20A/PV</b> 122073		
	10 x 38	25	900	<b>Z-C10/SE-25A/PV</b> 131703		

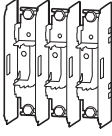
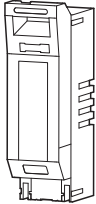
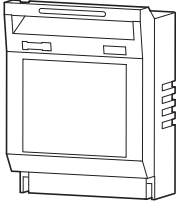
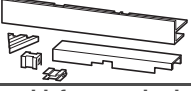
	Pole	Part no. Article no.	Price See price list	Std. pack
<b>Fuse switch-disconnectors, empty</b>				
• For cylindrical fuses				
	Size 14 x 51, to 50 A			
	Without flashing function			
	1	<b>VLC14-1P</b> 285361		12 off
	1 + N	<b>VLC14-1P+N</b> 285362		6 off
	2	<b>VLC14-2P</b> 285363		6 off
	3	<b>VLC14-3P</b> 285364		4 off
	3 + N	<b>VLC14-3P+N</b> 285365		3 off
	With flashing function			
	1	<b>VLC14-1P/L</b> 285371		12 off
	1 + N	<b>VLC14-1P+N/L</b> 285372		6 off
	2	<b>VLC14-2P/L</b> 285373		6 off
	3	<b>VLC14-3P/L</b> 285374		4 off
	3 + N	<b>VLC14-3P+N/L</b> 285375		3 off
		Size 22 x 58, to 100 A		
Without flashing function				
1		<b>VLC22-1P</b> 285366		3 off
1 + N		<b>VLC22-1P+N</b> 285367		2 off
2		<b>VLC22-2P</b> 285368		2 off
3		<b>VLC22-3P</b> 285369		1 off
3 + N		<b>VLC22-3P+N</b> 285370		1 off
With flashing function				
1		<b>VLC22-1P/L</b> 285376		3 off
1 + N		<b>VLC22-1P+N/L</b> 285377		2 off
2		<b>VLC22-2P/L</b> 285378		2 off
3		<b>VLC22-3P/L</b> 285379		1 off
3 + N		<b>VLC22-3P+N/L</b> 285380		1 off

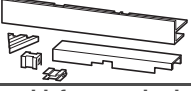

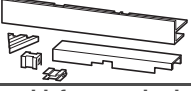



Size	Rated operational current $I_e$ A	Rated operational voltage $U_e$ V AC	Part no. Article no.  Utilization category gG (gL)	Price See price list	Rated operational voltage $U_e$ V AC	Part no. Article no.  Utilization category aM	Price See price list	Std. pack
<b>Cylindrical fuse inserts Z-C.../SE</b>								
	10 x 38	1	500	Z-C10/SE-1A/GG 112156		500	Z-C10/SE-1A/AM 112188	10 off
		2	500	Z-C10/SE-2A/GG 112157		500	Z-C10/SE-2A/AM 112189	
		4	500	Z-C10/SE-4A/GG 112158		500	Z-C10/SE-4A/AM 112190	
		6	500	Z-C10/SE-6A/GG 112159		500	Z-C10/SE-6A/AM 112191	
		8	500	Z-C10/SE-8A/GG 112160		500	Z-C10/SE-8A/AM 112192	
		10	500	Z-C10/SE-10A/GG 112161		500	Z-C10/SE-10A/AM 112193	
		12	500	Z-C10/SE-12A/GG 112162		500	Z-C10/SE-12A/AM 112194	
		16	500	Z-C10/SE-16A/GG 112163		500	Z-C10/SE-16A/AM 112195	
		20	500	Z-C10/SE-20A/GG 112164		400	Z-C10/SE-20A/AM 112196	
		25	500	Z-C10/SE-25A/GG 112165		400	Z-C10/SE-25A/AM 112197	
		32	400	Z-C10/SE-32A/GG 112166		400	Z-C10/SE-32A/AM 112198	
	14 x 51	2	690	Z-C14/SE-2A/GG 112167		690	Z-C14/SE-2A/AM 112199	
		4	690	Z-C14/SE-4A/GG 112168		690	Z-C14/SE-4A/AM 112200	
		6	690	Z-C14/SE-6A/GG 112169		690	Z-C14/SE-6A/AM 112201	
		8	690	Z-C14/SE-8A/GG 112170		690	Z-C14/SE-8A/AM 112202	
		10	690	Z-C14/SE-10A/GG 112171		690	Z-C14/SE-10A/AM 112203	
		12	690	Z-C14/SE-12A/GG 112172		690	Z-C14/SE-12A/AM 112204	
		16	690	Z-C14/SE-16A/GG 112173		690	Z-C14/SE-16A/AM 112205	
		20	690	Z-C14/SE-20A/GG 112174		690	Z-C14/SE-20A/AM 112206	
		25	690	Z-C14/SE-25A/GG 112175		690	Z-C14/SE-25A/AM 112207	
		32	690	Z-C14/SE-32A/GG 112176		500	Z-C14/SE-32A/AM 112208	
		40	500	Z-C14/SE-40A/GG 112177		500	Z-C14/SE-40A/AM 112209	
		50	500	Z-C14/SE-50A/GG 112178		500	Z-C14/SE-50A/AM 112210	
			22 x 58	16	690	Z-C22/SE-16A/GG 112179		
20	690			Z-C22/SE-20A/GG 112180		690	Z-C22/SE-20A/AM 112212	
25	690			Z-C22/SE-25A/GG 112181		690	Z-C22/SE-25A/AM 112213	
32	690			Z-C22/SE-32A/GG 112182		690	Z-C22/SE-32A/AM 112214	
40	690			Z-C22/SE-40A/GG 112183		690	Z-C22/SE-40A/AM 112215	
50	500			Z-C22/SE-50A/GG 112184		690	Z-C22/SE-50A/AM 112216	
63	500			Z-C22/SE-63A/GG 112185		500	Z-C22/SE-63A/AM 112217	
80	500			Z-C22/SE-80A/GG 112186		500	Z-C22/SE-80A/AM 112218	
100	500			Z-C22/SE-100A/GG 112187		500	Z-C22/SE-100A/AM 112219	

	Rated operating current $I_e$ A	Max. fuse link			Part no. Article no.	Price See price list	Std. pack	Notes																																																											
		500 V A	690 V A	Size																																																															
<b>LV h.b.c. fuse bases</b>																																																																			
<b>3 pole</b>																																																																			
	160	160	100	NH00	<b>GS00-160</b> 026741		1 off	–																																																											
	250	250	200	NH1	<b>GSU1</b> 289016		1 off	–																																																											
	400	400	315	NH2	<b>GSU2</b> 289017		1 off	–																																																											
	630	630	500	NH3	<b>GSU3</b> 289018		1 off	–																																																											
<b>LV h.b.c. fuse switch-disconnectors</b>																																																																			
For fitting on mounting plate																																																																			
	1 pole without hand guard	160	160	100	NH00	<b>GSTA00-160-1P</b> 225000	1 off	For fitting to GSTA00-160 for four pole LV h.b.c. fuse switch-disconnector, two devices can be combined to two pole LV h.b.c. fuse switch-disconnector																																																											
	3 pole without hand guard	160	160	100	NH00	<b>GSTA00-160</b> 095558	1 off	–																																																											
		250	250	200	NH1	<b>GSTA1</b> 017250	1 off	–																																																											
		400	400	315	NH2	<b>GSTA2</b> 021996	1 off	–																																																											
		630	630	500	NH3	<b>GSTA3</b> 026742	1 off	–																																																											
<table border="1"> <thead> <tr> <th></th> <th>Rated operational voltage <math>U_e</math> V</th> <th>Fuse link Size</th> <th>For use with</th> <th>Part no. Article no.</th> <th>Price See price list</th> <th>Std. pack</th> </tr> </thead> <tbody> <tr> <td colspan="7"><b>Set of connecting links</b></td> </tr> <tr> <td></td> <td>–</td> <td>00</td> <td>GSTA00-160-1P</td> <td><b>V-GSTA00-1P</b> 228173</td> <td></td> <td>1 off</td> </tr> <tr> <td colspan="7"><b>Cover with fuse monitoring</b></td> </tr> <tr> <td rowspan="4"></td> <td colspan="6"> <ul style="list-style-type: none"> <li>One green operation indicator LED, three red error indication LEDs (F1, F2, F3)</li> <li>Error message through relay contacts (floating) 1 N/O + 1 NC</li> <li>AC15: 24 V/4 A, 230 V/3 A</li> <li>AC13: 24 V/1 A, 220 V/0.5 A, terminal capacity 0.25 – 1.5 mm<sup>2</sup></li> </ul> </td> </tr> <tr> <td>400 - 690 V AC / 50 - 60 Hz</td> <td>00</td> <td>GSTA00...</td> <td><b>GST00-DSI</b> 107956</td> <td></td> <td>1 off</td> </tr> <tr> <td>400 - 690 V AC / 50 - 60 Hz</td> <td>1</td> <td>GSTA1...</td> <td><b>GST1-DSI</b> 107957</td> <td></td> <td>1 off</td> </tr> <tr> <td>400 - 690 V AC / 50 - 60 Hz</td> <td>2</td> <td>GSTA2...</td> <td><b>GST2-DSI</b> 107958</td> <td></td> <td>1 off</td> </tr> <tr> <td>400 - 690 V AC / 50 - 60 Hz</td> <td>3</td> <td>GSTA3...</td> <td><b>GST3-DSI</b> 107959</td> <td></td> <td>1 off</td> </tr> </tbody> </table>										Rated operational voltage $U_e$ V	Fuse link Size	For use with	Part no. Article no.	Price See price list	Std. pack	<b>Set of connecting links</b>								–	00	GSTA00-160-1P	<b>V-GSTA00-1P</b> 228173		1 off	<b>Cover with fuse monitoring</b>								<ul style="list-style-type: none"> <li>One green operation indicator LED, three red error indication LEDs (F1, F2, F3)</li> <li>Error message through relay contacts (floating) 1 N/O + 1 NC</li> <li>AC15: 24 V/4 A, 230 V/3 A</li> <li>AC13: 24 V/1 A, 220 V/0.5 A, terminal capacity 0.25 – 1.5 mm<sup>2</sup></li> </ul>						400 - 690 V AC / 50 - 60 Hz	00	GSTA00...	<b>GST00-DSI</b> 107956		1 off	400 - 690 V AC / 50 - 60 Hz	1	GSTA1...	<b>GST1-DSI</b> 107957		1 off	400 - 690 V AC / 50 - 60 Hz	2	GSTA2...	<b>GST2-DSI</b> 107958		1 off	400 - 690 V AC / 50 - 60 Hz	3	GSTA3...	<b>GST3-DSI</b> 107959		1 off
	Rated operational voltage $U_e$ V	Fuse link Size	For use with	Part no. Article no.	Price See price list	Std. pack																																																													
<b>Set of connecting links</b>																																																																			
	–	00	GSTA00-160-1P	<b>V-GSTA00-1P</b> 228173		1 off																																																													
<b>Cover with fuse monitoring</b>																																																																			
	<ul style="list-style-type: none"> <li>One green operation indicator LED, three red error indication LEDs (F1, F2, F3)</li> <li>Error message through relay contacts (floating) 1 N/O + 1 NC</li> <li>AC15: 24 V/4 A, 230 V/3 A</li> <li>AC13: 24 V/1 A, 220 V/0.5 A, terminal capacity 0.25 – 1.5 mm<sup>2</sup></li> </ul>																																																																		
	400 - 690 V AC / 50 - 60 Hz	00	GSTA00...	<b>GST00-DSI</b> 107956		1 off																																																													
	400 - 690 V AC / 50 - 60 Hz	1	GSTA1...	<b>GST1-DSI</b> 107957		1 off																																																													
	400 - 690 V AC / 50 - 60 Hz	2	GSTA2...	<b>GST2-DSI</b> 107958		1 off																																																													
400 - 690 V AC / 50 - 60 Hz	3	GSTA3...	<b>GST3-DSI</b> 107959		1 off																																																														

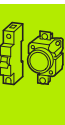
WWW.TM2A.PT info@tm2a.pt

WWW.TM2A.PT info@tm2a.pt

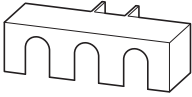

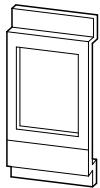
	Fuse link Size	For use with	Connection	Part no. Article no.	Price See price list	Std. pack
<b>Busbar tag shroud 1 pole</b>						
	00	GSTA00-160-1P	Connection top or bottom	<b>ZBS-GSTA00-1P</b> 119006		2 off
	1	GSTA1-1P	Connection top or bottom	<b>ZBS-GSTA1-1P</b> 119007		2 off
	3	GSTA3-1P	Connection top or bottom	<b>ZBS-GSTA3-1P</b> 119008		2 off
<b>Busbar tag shroud 3 pole</b>						
	00	GSTA00-160	Connection top or bottom	<b>ZBS-GSTA00</b> 014411		10 off
	1	GSTA1	Connection at the top	<b>ZBS-GSTA1</b> 082800		10 off
	1	GSTA1	Connection at the bottom	<b>ZBSU-GSTA1</b> 082804		10 off
	2	GSTA2	Connection at the top	<b>ZBS-GSTA2</b> 082801		5 off
	2	GSTA2	Connection at the bottom	<b>ZBSU-GSTA2</b> 082805		10 off
	3	GSTA3	Connection at the top	<b>ZBS-GSTA3</b> 082802		1 off
	3	GSTA3	Connection at the bottom	<b>ZBSU-GSTA3</b> 082806		10 off
<b>Clip set</b>						
able to be fitted later, adjustable snap fitting to two top hat rails to IEC/EN 60715 (35 mm) For intervals between busbar centres of 100 - 125 mm						
	-	GSTA00-160		<b>C-GSTA00</b> 040922		5 off
One set comprises 3 clamp-type terminals.						
	Terminal range 1 x (70 - 150) mm <sup>2</sup> Cu/Al	GSU1, GST...1		<b>PSK1</b> 038734		1 off
	Terminal range 1 x (120 - 240) mm <sup>2</sup> Cu/Al	GSU2, GST...2		<b>PSK2</b> 043480		1 off
	Terminal range 1 x (120 - 300) mm <sup>2</sup> Cu/Al	GSU3, GST...3		<b>PSK3</b> 048226		1 off
<b>Sets of double clamp-type terminals</b>						
One set comprises 3 double clamp-type terminals						
	Terminal range 2 x (70 - 95) mm <sup>2</sup> Cu/Al	GSU1, GST...1		<b>PSK12</b> 041107		1 off
	Terminal range 2 x (120 - 150) mm <sup>2</sup> Cu/Al	GSU2, GST...2		<b>PSK22</b> 045853		1 off
	Terminal range 2 x (120-240) mm <sup>2</sup> Cu/Al	GSU3, GST...3		<b>PSK32</b> 050599		1 off
<b>Insulating surround for fuse switch-disconnectors</b>						
For compensation between the GA... protective cover and the device (for use in the CI insulated distribution board system)						
	-	GST00		<b>B-GST00-40-60/CI/1</b> 224553		5 off

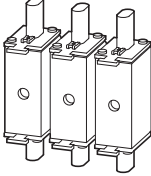

Size	Rated operational current $I_e$ A	Part no. Article no.	Price See price list	Std. pack
<b>LV h.b.c. fuse links</b>				
<ul style="list-style-type: none"> <li>• Insulation body made from Steatite/Corderite</li> <li>• Copper contact blade with silver coating, corrosion proof</li> <li>• Pivoting and central indicator, live grip tabs</li> <li>• Selectivity from 1:1.6</li> </ul>				
	00	10	Z-NH-00/10 289998	3 off
	00	16	Z-NH-00/16 289999	3 off
	00	20	Z-NH-00/20 290000	3 off
	00	25	Z-NH-00/25 290001	3 off
	00	35	Z-NH-00/35 290002	3 off
	00	40	Z-NH-00/40 290003	3 off
	00	50	Z-NH-00/50 290004	3 off
	00	63	Z-NH-00/63 290005	3 off
	00	80	Z-NH-00/80 290006	3 off
	00	100	Z-NH-00/100 290007	3 off
00	125	Z-NH-00/125 290008	3 off	
00	160	Z-NH-00/160 290009	3 off	
1	50	Z-NH-1/50 290010	3 off	
1	63	Z-NH-1/63 290011	3 off	
1	80	Z-NH-1/80 290012	3 off	
1	100	Z-NH-1/100 290013	3 off	
1	125	Z-NH-1/125 290014	3 off	
1	160	Z-NH-1/160 290015	3 off	
1	200	Z-NH-1/200 290016	3 off	
1	250	Z-NH-1/250 290017	3 off	
2	100	Z-NH-2/100 290018	3 off	
2	125	Z-NH-2/125 290019	3 off	
2	160	Z-NH-2/160 290020	3 off	
2	200	Z-NH-2/200 290021	3 off	
2	250	Z-NH-2/250 290022	3 off	
2	315	Z-NH-2/315 290023	3 off	
2	400	Z-NH-2/400 290024	3 off	
3	250	Z-NH-3/250 290025	3 off	
3	315	Z-NH-3/315 290026	3 off	
3	400	Z-NH-3/400 290027	3 off	
3	500	Z-NH-3/500 290028	3 off	
3	630	Z-NH-3/630 290029	3 off	

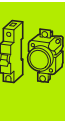

Engineering

Influence of the ambient temperature on the thermal trip behavior

Corrected values of the rated operational current dependent on the ambient temperature

FAZ..., FAZT...

FAZ-...-NA, FAZ-...-RT

Ambient temperature T [°C]																	
I <sub>n</sub> [A]	-40	-30	-20	-10	0	10	20	30	35	40	45	50	55	60	65	70	75
0.16	0.20	0.20	0.19	0.19	0.18	0.17	0.17	0.16	0.16	0.15	0.15	0.15	0.14	0.14	0.14	0.14	0.13
0.25	0.32	0.31	0.30	0.29	0.28	0.27	0.26	0.25	0.25	0.24	0.24	0.23	0.23	0.22	0.22	0.21	0.21
0.5	0.64	0.62	0.60	0.58	0.56	0.54	0.52	0.50	0.49	0.48	0.47	0.46	0.45	0.44	0.43	0.42	0.41
0.75	0.96	0.93	0.90	0.87	0.84	0.81	0.78	0.75	0.74	0.73	0.71	0.69	0.68	0.66	0.65	0.64	0.62
1	1.3	1.2	1.2	1.2	1.1	1.1	1.0	1.0	0.99	0.97	0.95	0.93	0.90	0.89	0.87	0.85	0.83
1.5	1.9	1.9	1.8	1.7	1.7	1.6	1.6	1.5	1.5	1.5	1.4	1.4	1.4	1.3	1.3	1.3	1.2
1.6	2.0	2.0	1.9	1.9	1.8	1.7	1.7	1.6	1.6	1.5	1.5	1.5	1.4	1.4	1.4	1.4	1.3
2	2.6	2.5	2.4	2.3	2.2	2.2	2.1	2.0	2.0	1.9	1.9	1.9	1.8	1.8	1.7	1.7	1.7
2.5	3.2	3.1	3.0	2.9	2.8	2.7	2.6	2.5	2.5	2.4	2.4	2.3	2.3	2.2	2.2	2.1	2.1
3	3.8	3.7	3.6	3.5	3.4	3.3	3.1	3.0	3.0	2.9	2.8	2.8	2.7	2.7	2.6	2.5	2.5
3.5	4.5	4.4	4.2	4.1	3.9	3.8	3.7	3.5	3.4	3.4	3.3	3.2	3.2	3.1	3.0	3.0	2.9
4	5.1	5.0	4.8	4.7	4.5	4.3	4.2	4.0	3.9	3.9	3.8	3.7	3.6	3.5	3.5	3.4	3.3
5	6.4	6.0	6.0	5.8	5.6	5.4	5.2	5.0	4.9	4.8	4.7	4.6	4.5	4.4	4.3	4.2	4.1
6	7.7	7.5	7.2	7.0	6.7	6.5	6.3	6.0	5.9	5.8	5.7	5.6	5.4	5.3	5.2	5.1	5.0
8	10.2	9.9	9.6	9.3	9.0	8.7	8.4	8.0	7.9	7.7	7.6	7.4	7.2	7.1	6.9	6.8	6.6
10	13	12	12	12	11	11	10	10	9.9	9.7	9.5	9.3	9.0	8.9	8.7	8.5	8.3
12	15	15	14	14	13	13	13	12	12	12	11	11	11	11	10	10	10
13	17	16	16	15	15	14	14	13	13	13	12	12	12	12	11	11	11
15	19	19	18	17	17	16	16	15	15	15	14	14	14	13	13	13	12
16	20	20	19	19	18	17	17	16	16	15	15	15	14	14	14	14	13
20	26	25	24	23	22	22	21	20	20	19	19	19	18	18	17	17	17
25	32	31	30	29	28	27	26	25	25	24	24	23	23	22	22	21	21
32	41	40	38	37	36	35	33	32	32	31	30	30	29	28	28	27	26
40	51	50	48	47	45	43	42	40	39	39	38	37	36	35	35	34	33
50	64	62	60	58	56	54	52	50	49	48	47	46	45	44	43	42	41
63	81	78	76	73	71	68	66	63	62	61	60	58	57	56	55	53	52

Ambient temperature T [°C]									
I <sub>n</sub> [A]	15	20	25	30	40	50	55	60	
0.5	0.6	0.5	0.5	0.5	0.5	0.5	0.5	0.5	
1.0	1.1	1.1	1.1	1.0	1.0	1.0	0.9	0.9	
1.5	1.7	1.6	1.6	1.6	1.5	1.4	1.4	1.4	
2.0	2.2	2.2	2.1	2.1	2.0	1.9	1.9	1.8	
3.0	3.3	3.2	3.2	3.1	3.0	2.9	2.9	2.8	
4.0	4.4	4.3	4.2	4.2	4.0	3.8	3.8	3.7	
5.0	5.5	5.4	5.3	5.2	5.0	4.8	4.7	4.6	
6.0	6.6	6.5	6.4	6.2	6.0	5.8	5.6	5.5	
7.0	7.7	7.6	7.4	7.3	7.0	6.7	6.6	6.4	
8.0	8.8	8.6	8.5	8.3	8.0	7.7	7.5	7.4	
10.0	11.0	10.8	10.6	10.4	10.0	9.6	9.4	9.2	
13.0	14.3	14.0	13.8	13.5	13.0	12.5	12.5	12.0	
15.0	16.5	16.2	15.9	15.6	15.0	14.4	14.1	13.8	
16.0	17.6	17.3	17.0	16.6	16.0	15.4	15.0	14.7	
20.0	22.0	21.6	21.2	20.8	20.0	19.2	18.8	18.4	
25.0	27.5	27.0	26.5	26.0	25.0	24.0	23.3	23.0	
30.0	33.0	32.4	31.8	31.2	30.0	28.8	28.2	27.6	
32.0	35.2	34.6	33.9	33.3	32.0	30.7	30.1	29.4	
40.0	44.0	43.2	42.4	41.6	40.0	38.4	37.6	36.8	

Heat dissipation FAZT

Depending on rated operational current I<sub>n</sub>

I <sub>n</sub> [A]	Characteristic C			Characteristic D		
	Pole			Pole		
	1	2	3	1	2	3
	P [W]	P [W]	P [W]	P [W]	P [W]	P [W]
0.5	1.6	3.2	4.7	1.6	3.2	4.8
1	1.1	2.2	3.4	0.8	1.5	2.3
1.5	1.3	2.6	3.9	1.0	2.1	3.1
2	1.4	2.8	4.3	1.0	2.1	3.1
3	1.2	2.4	3.6	1.2	2.4	3.6
4	1.4	2.9	4.3	1.4	2.9	4.3
5	1.9	3.7	5.6	1.5	2.9	4.4
6	1.2	2.3	3.5	1.2	2.3	3.5
7	1.4	2.8	4.3	1.4	2.8	4.3
8	1.4	2.8	4.2	1.2	2.4	3.7
10	1.9	3.6	5.3	1.5	3.0	4.5
13	2.4	4.7	7.1	2.0	4.1	6.1
15	1.9	3.8	5.6	1.5	3.1	4.6
16	2.1	4.3	6.4	1.7	3.5	5.2
20	2.9	5.8	8.7	1.8	3.7	5.5
25	3.1	6.2	9.3	2.6	5.1	7.7
30	3.0	6.0	9.0	2.7	5.4	8.1
32	3.4	6.8	10.2	3.1	6.2	9.3
35	3.7	7.4	11.0	3.8	7.6	11.3
40	4.0	8.1	12.1	3.9	7.8	11.6

Heat dissipation FAZ-...-NA, FAZ-...-RT

Depending on rated operational current I<sub>n</sub>

I <sub>n</sub> [A]	Characteristic C			Characteristic D		
	Pole			Pole		
	1	2	3	1	2	3
	P [W]	P [W]	P [W]	P [W]	P [W]	P [W]
0.5	1.6	3.2	4.7	1.6	3.2	4.8
1	1.1	2.2	3.4	0.8	1.5	2.3
1.5	1.3	2.6	3.9	1.0	2.1	3.1
2	1.4	2.8	4.3	1.0	2.1	3.1
3	1.2	2.4	3.6	1.2	2.4	3.6
4	1.4	2.9	4.3	1.4	2.9	4.3
5	1.9	3.7	5.6	1.5	2.9	4.4
6	1.2	2.3	3.5	1.2	2.3	3.5
7	1.4	2.8	4.3	1.4	2.8	4.3
8	1.4	2.8	4.2	1.2	2.4	3.7
10	1.8	3.6	5.3	1.5	3.0	4.5
13	2.4	4.7	7.1	2.0	4.1	6.1
15	1.9	3.8	5.6	1.5	3.1	4.6
16	2.1	4.3	6.4	1.7	3.5	5.2
20	2.9	5.8	8.7	1.8	3.7	5.5
25	3.1	6.2	9.3	2.6	5.1	7.7
30	3.0	6.0	9.0	2.7	5.4	8.1
32	3.4	6.8	10.2	3.1	6.2	9.3
35	3.7	7.4	11.0	3.8	7.6	11.3
40	4.0	8.1	12.1	3.9	7.8	11.6

WWW.TM2A.PT info@tm2a.pt

WWW.TM2A.PT info@tm2a.pt



Influence of the ambient temperature on the tripping behavior

FAZ-...-NA, FAZ-...-RT,

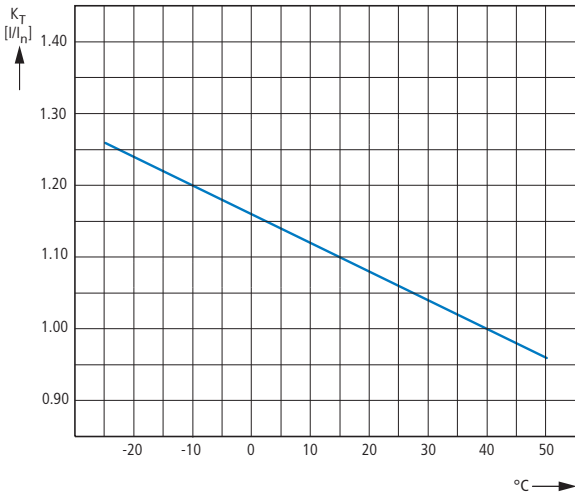

$K_T$  = rated diversity factor

PDIM leakage current meters

Contour and rail mounting compatible with other devices of the P series  
 Freely selectable rail arrangement top and bottom  
 Free terminal compartment despite fitted busbar  
 Power supply through ordering of the four conductors  
 Electronic operation (independent of mains voltage)

Mains connection on either side.  
 The 4 pole switch can also be used as 3 pole switch.  
 To do this, use terminals 1-2, 3-4 and 5-6.  
 The 4 pole switch can also be used as 2 pole switch.  
 To do this, use terminals 5-6 and N-N.  
 2 relays (N/O, parallel to yellow and red LED), floating  
 (up to 10 A/230 V-)

Function

Green LED lit on 0 – 30 % of set  $I_{\Delta n}$ .  
 Yellow LED lit on 30 – 50 % of set  $I_{\Delta n}$ .  
 Red LED lit on > 50 % of set  $I_{\Delta n}$ .  
 The yellow LED goes out when tripped if the measured fault current < 30 % of the set  $I_{\Delta n}$ .  
 The red LED goes remains lit when tripped, even if when the measured fault current < 50 % of the set  $I_{\Delta n}$ .  
 The red LED goes out only when the Reset button is pressed.  
 Only one LED lights up at any one time.  
 An output relay is always connected parallel to the yellow or red LED.  
 Depending on the set RCCB (non-delayed, G, or S) the fault current must flow for a specific time before an action takes place.

Test function

Rotary coding switch for RCCB function set to "TEST".  
 A fault current of 30 % and 50 %  $I_{\Delta n}$  is simulated in alternation.  
 The yellow and red LED flash alternately (1 Hz); both output relays are continually picked up.

info@tm2a.pt

info@tm2a.pt

WWW.TM2A.PT

WWW.TM2A.PT

Load carrying capacity with side-by-side miniature circuit-breakers FAZ...

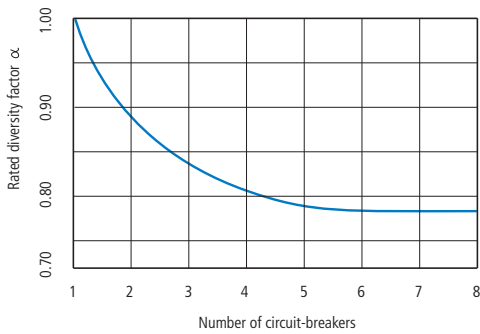

Influence of the mains frequency

Influence of the mains frequency on the tripping behavior  $I_{MA}$  of the instantaneous release

	Mains frequency f [Hz]						
	16 2/3	50	60	100	200	300	400
$I_{MA}(f)/I_{MA}(50 \text{ Hz})$ [%]	91	100	101	106	115	134	141

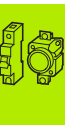

Residual-current devices

FI-...-B

Frequency response of the tripping current

30 mA

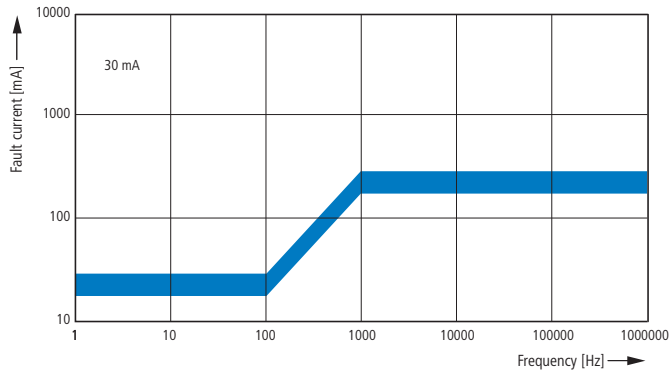

100 mA

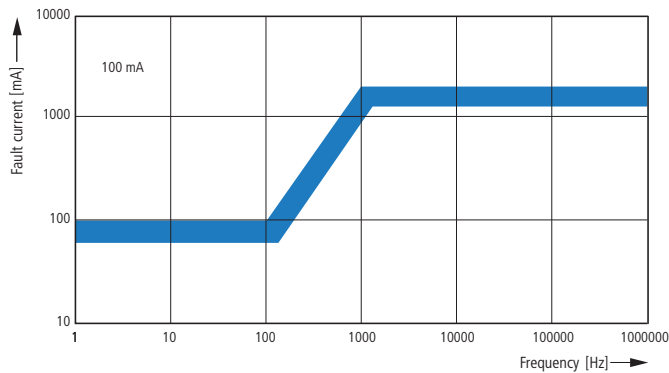

300 mA

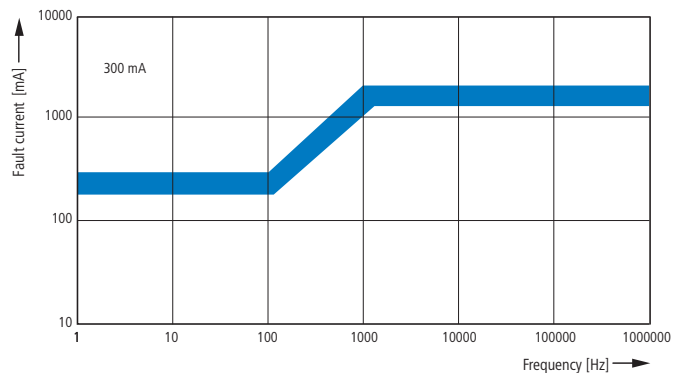

Miniature circuit-breakers (MCB)

FAZ...

Tripping characteristics at 30 °C:

B, C, D to IEC/EN 60898

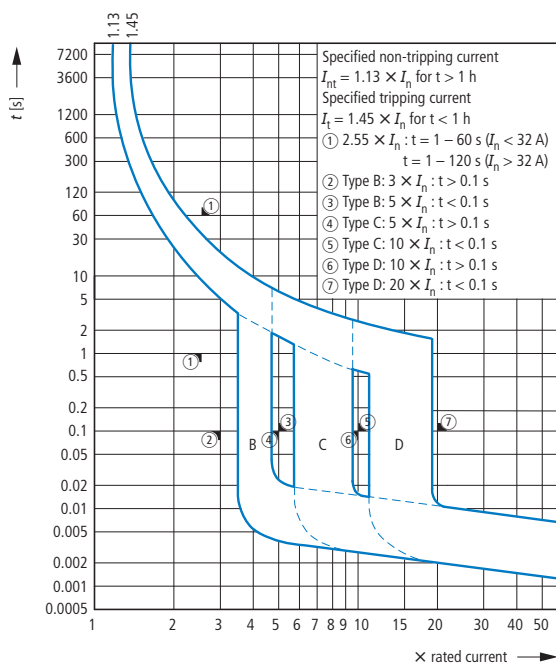

Tripping characteristics at 30 °C:

K according to IEC/EN 60947

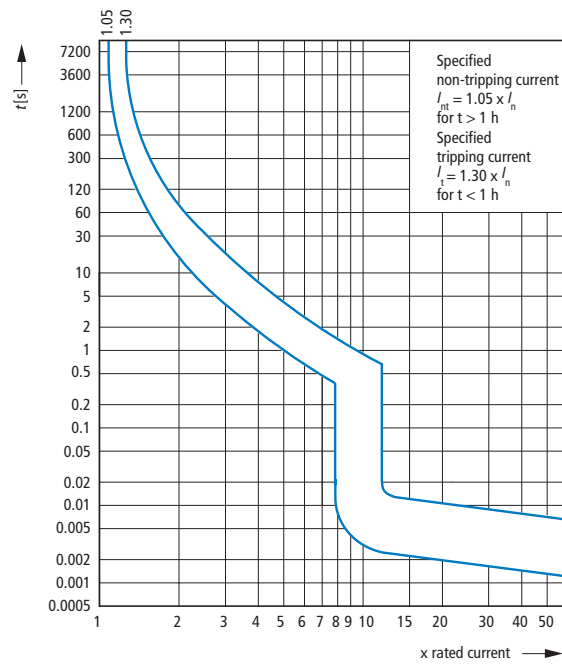

Miniature circuit-breakers (MCB)

FAZ...

Tripping characteristics at 30 °C:  
S according to IEC/EN 60947

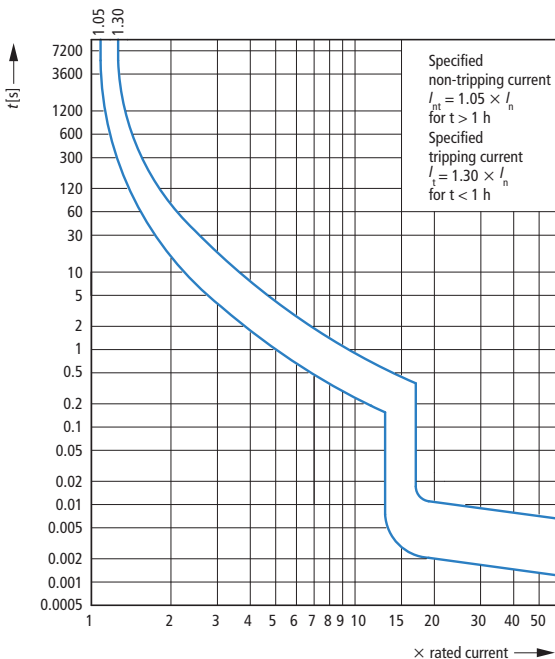

Tripping characteristics at 30 °C:  
Z according to IEC/EN 60947

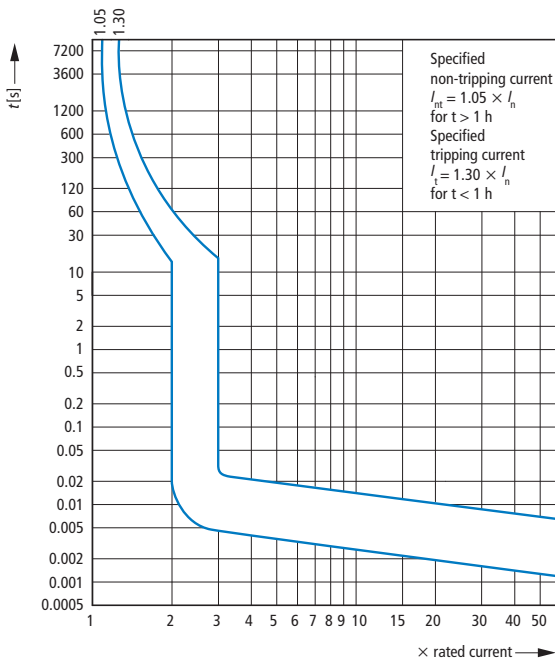

FAZT

Tripping characteristics FAZ at 30 °C  
B, C, D to IEC/EN 60898

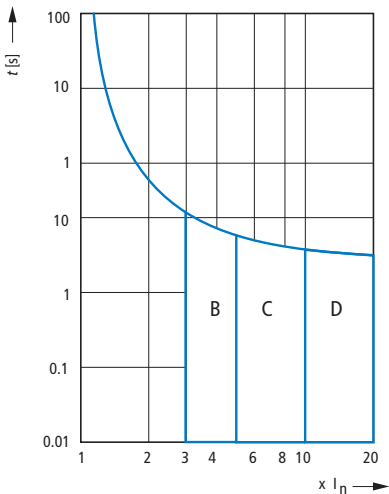

AZ...

Tripping characteristics at 30 °C:  
C, D according to IEC/EN 60898

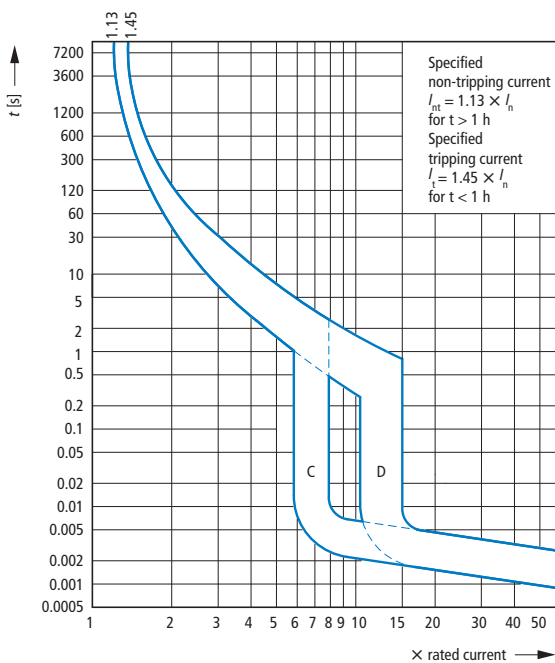

info@tm2a.pt

WWW.TM2A.PT

info@tm2a.pt

WWW.TM2A.PT



Combination switches

PKNM...

Tripping characteristics at 30 °C:

B, C according to IEC/EN 61009

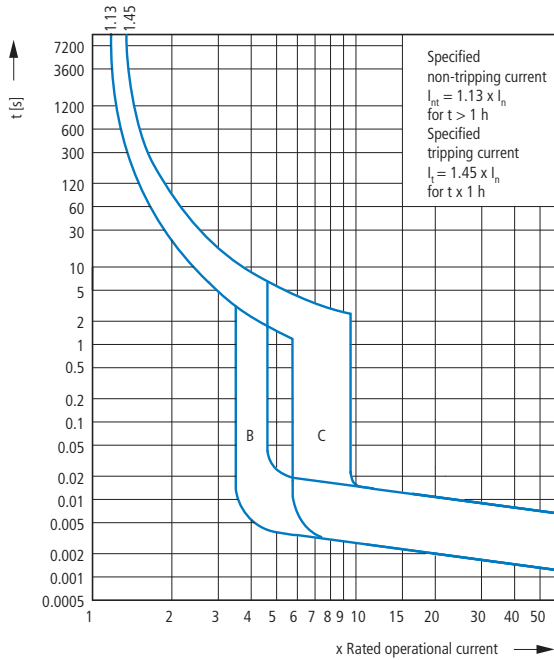

mRB6..., mRB4...

Tripping characteristics

B, C, D according to IEC/EN 61009

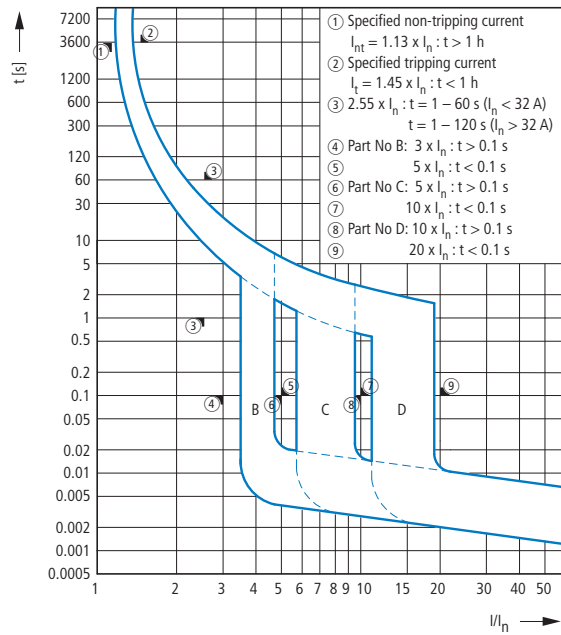

Miniature circuit-breakers (MCB)

FAZ-...-NA, FAZ-...-RT

Tripping characteristics according to UL 489

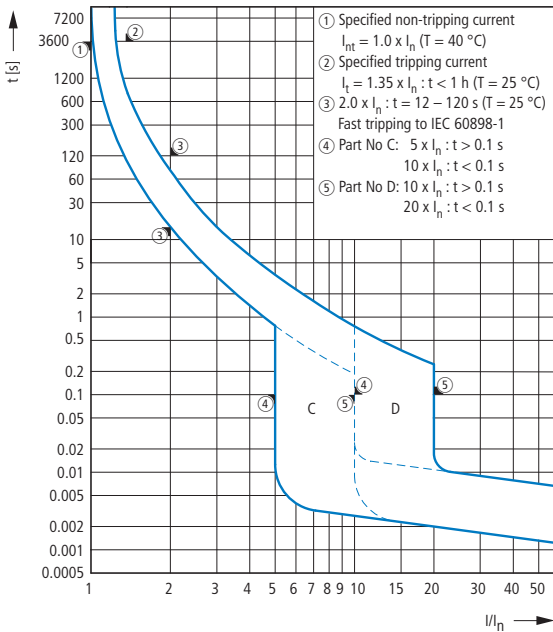

Miniature circuit-breakers (MCB)

FAZ...

Let-through energy  $I^2t$

According to IEC/EN 60898

Let-through current  $I_D$

According to IEC/EN 60898

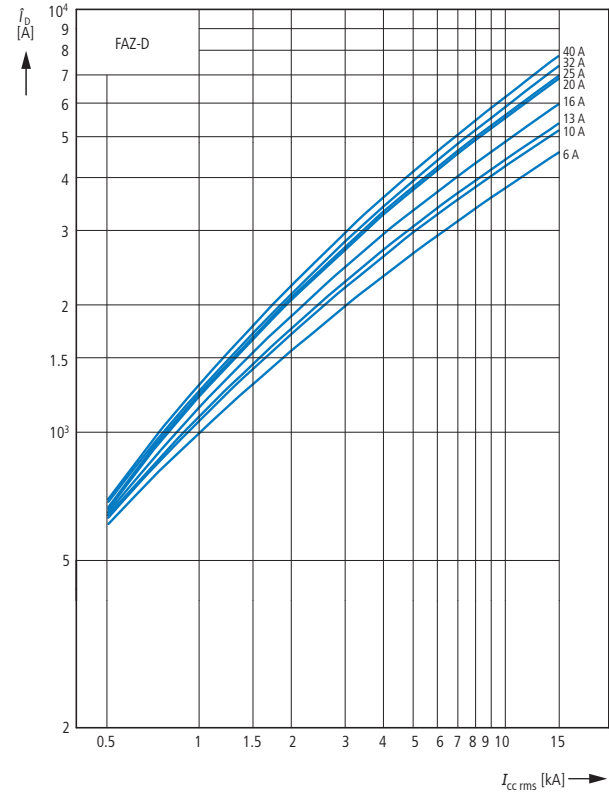
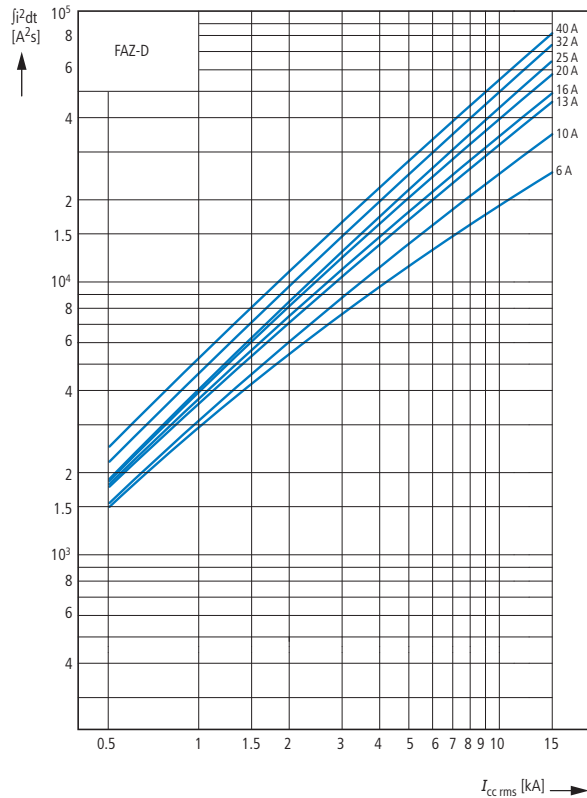
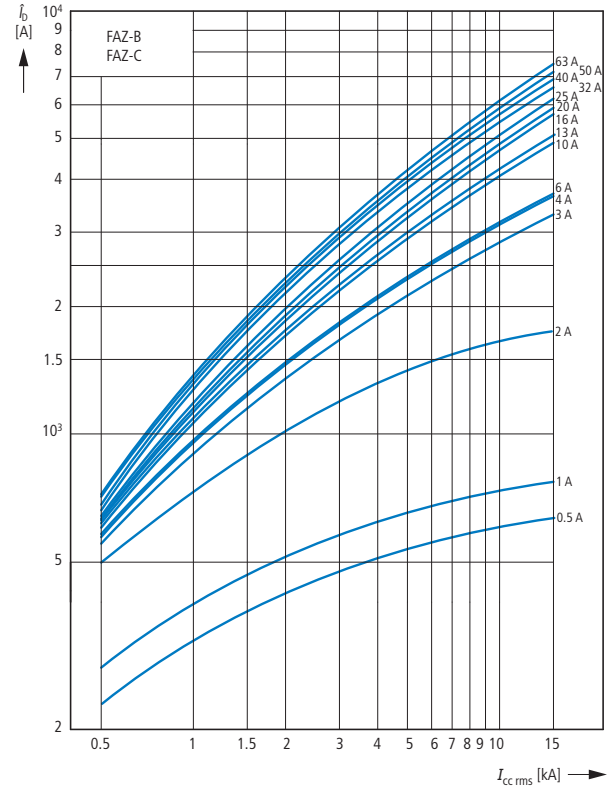
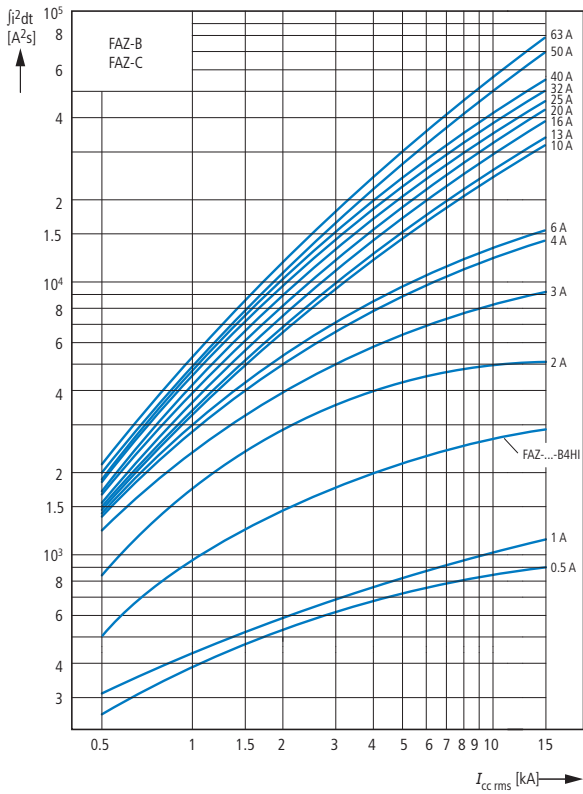

info@tm2a.pt

WWW.TM2A.PT

info@tm2a.pt

WWW.TM2A.PT





Miniature circuit-breakers (MCB)

FAZ...

Let-through energy  $I^2t$

According to IEC/EN 60898

Let-through current  $I_D$

According to IEC/EN 60898

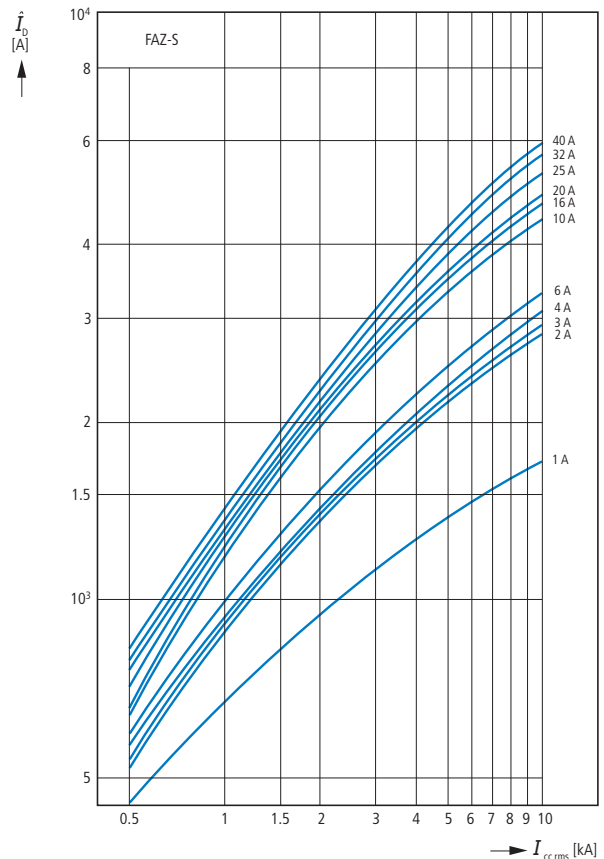
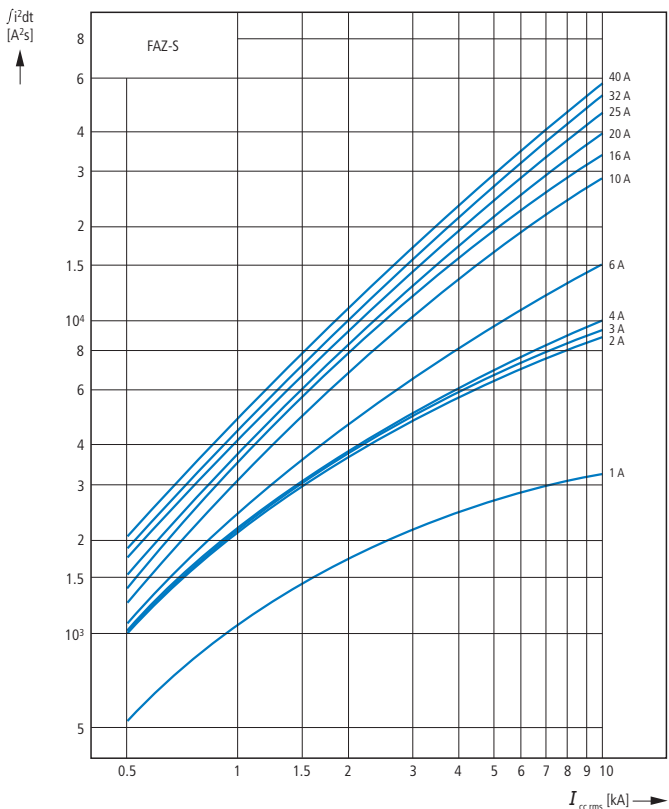
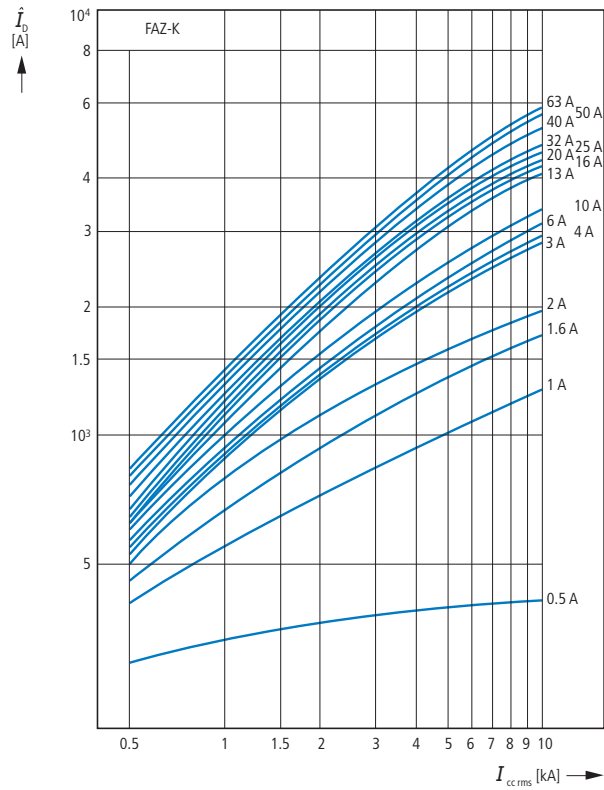
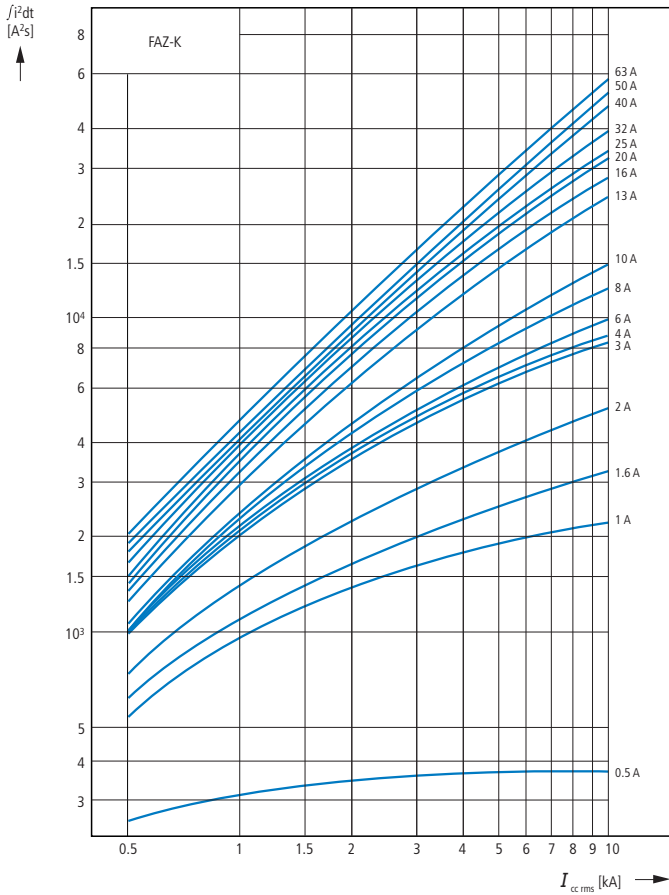

WWW.TM2A.PT info@tm2a.pt

WWW.TM2A.PT info@tm2a.pt



**Miniature circuit-breakers (MCB)**

**FAZ...**

Let-through energy  $I^2t$   
 According to IEC/EN 60898

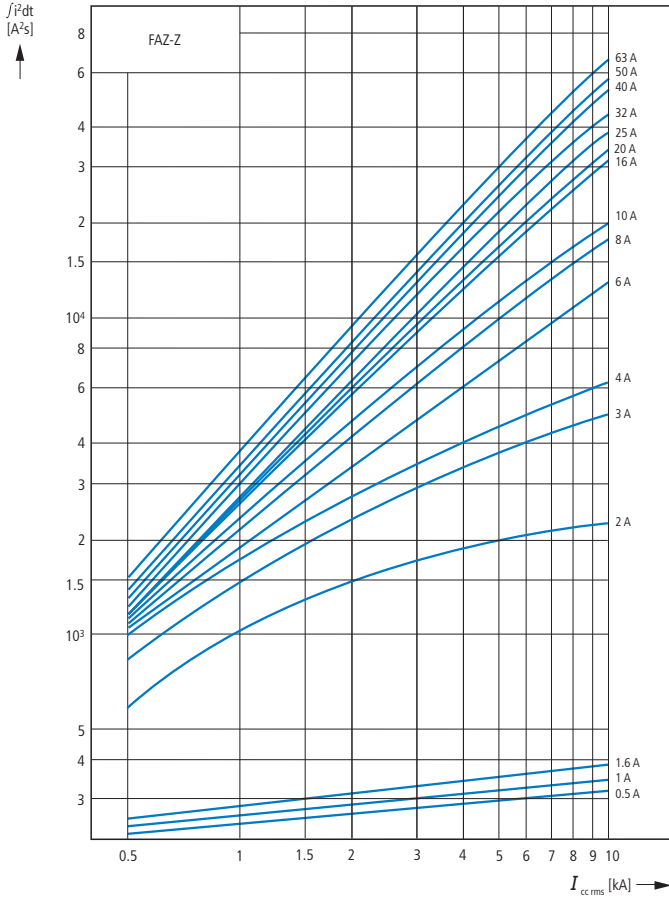

Let-through current  $I_D$   
 According to IEC/EN 60898

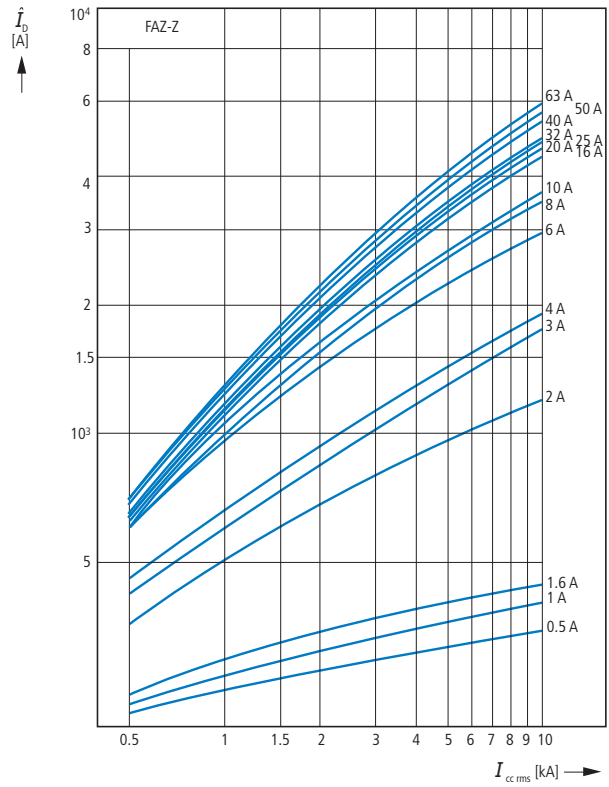

**AZ...**

Let-through energy  $I^2t$

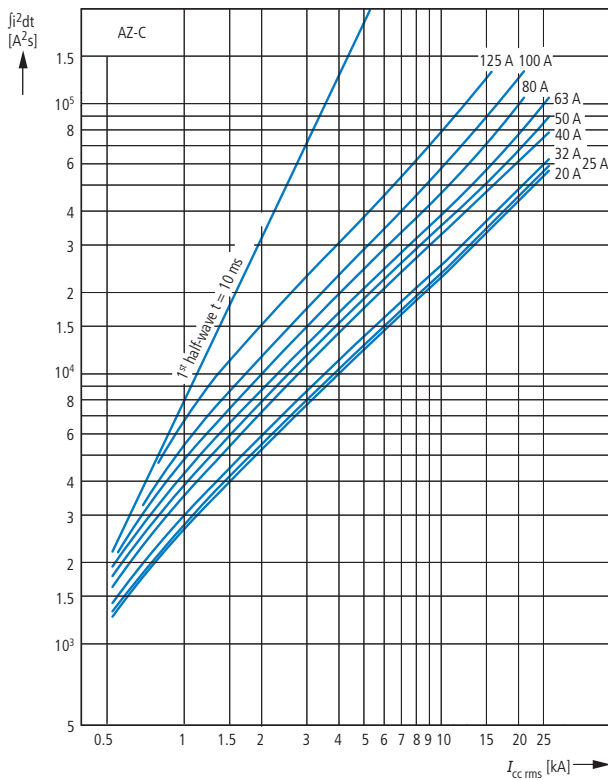

Let-through current  $I_D$

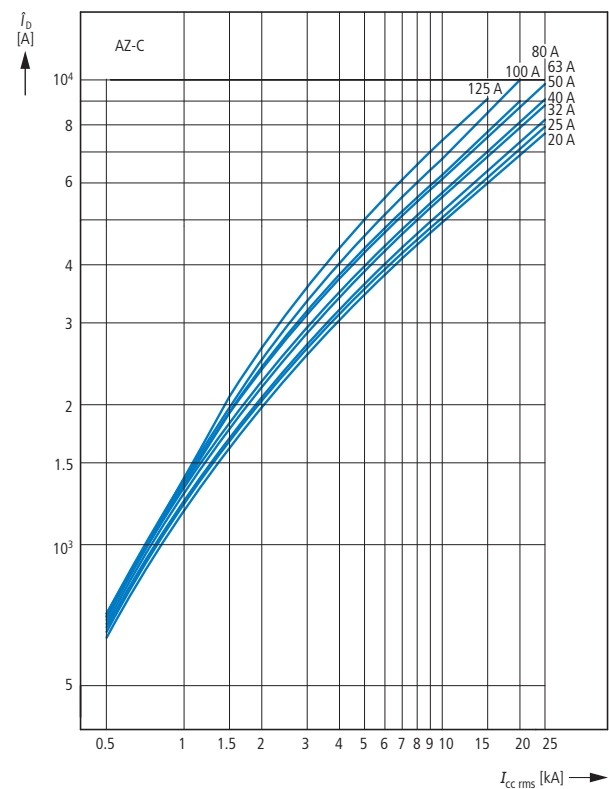

WWW.TM2A.PT info@tm2a.pt

WWW.TM2A.PT info@tm2a.pt

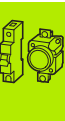

Miniature circuit-breakers

AZ...

Let-through energy  $I^2t$

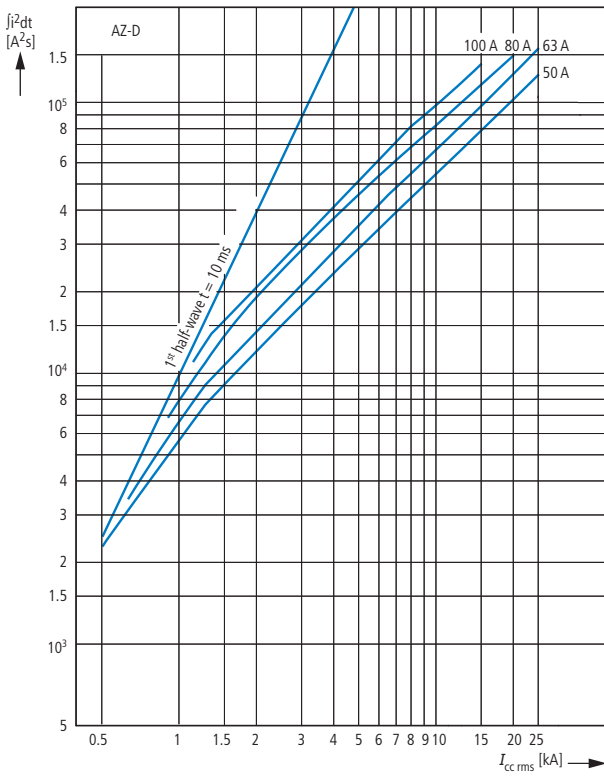

Let-through current  $I_D$

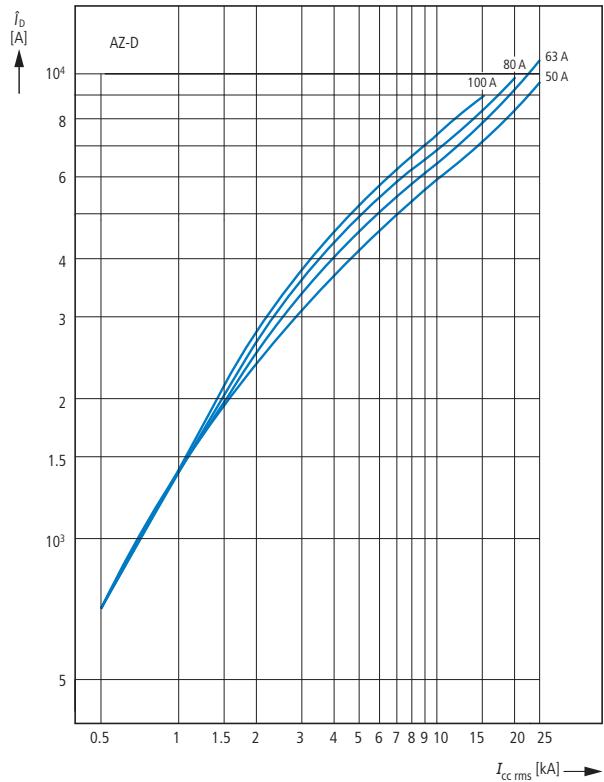

Combination switches

PKNM-...

Let-through energy  $I^2t$

According to IEC/EN 60898

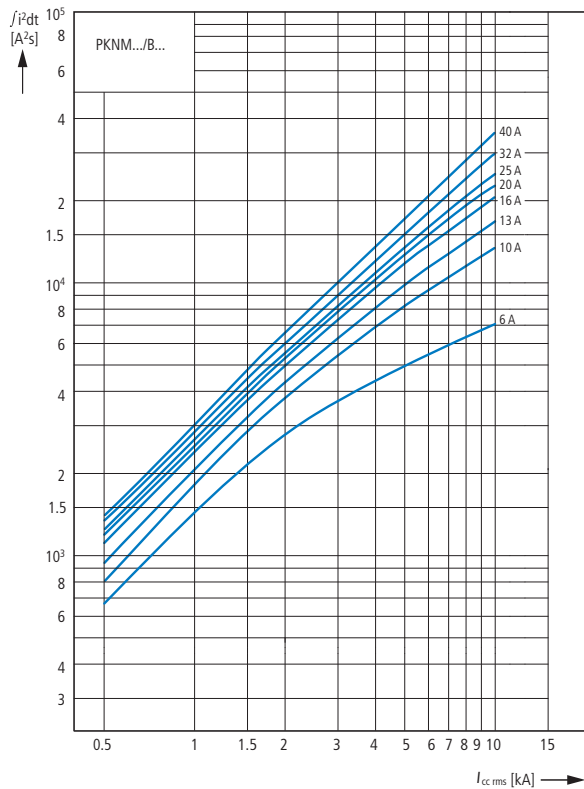

Let-through current  $I_D$

According to IEC/EN 60898

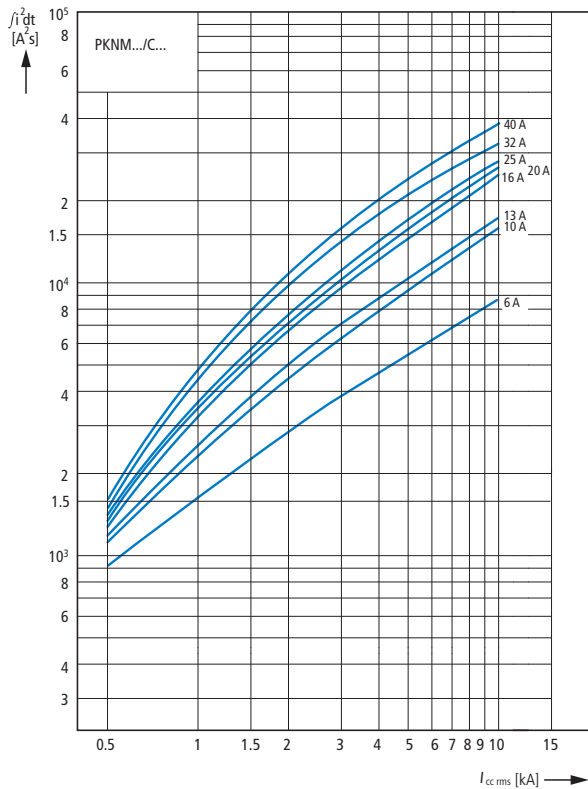

info@tm2a.pt

WWW.TM2A.PT

info@tm2a.pt

WWW.TM2A.PT



Miniature circuit-breakers (MCB)

FAZ-...NA, FAZ-...RT

Let-through energy  $I^2t$

Characteristic C (0.5 - 20 A), 277 V

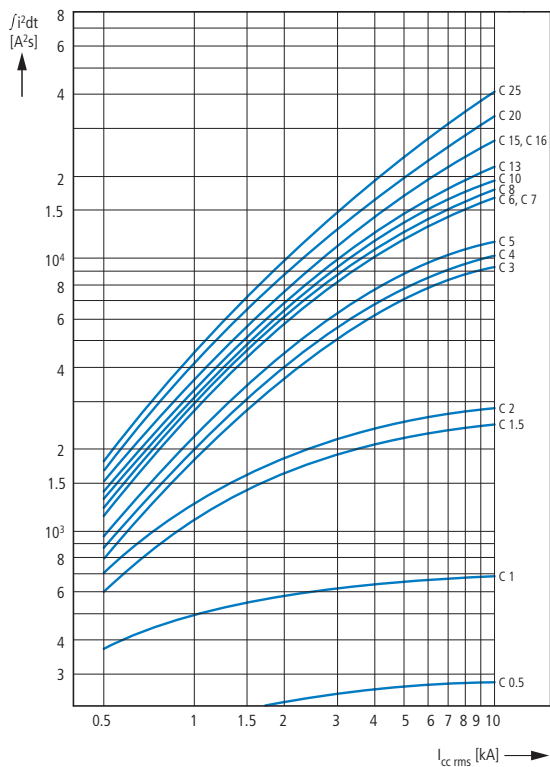

Characteristic C (25 - 40 A), 240 V

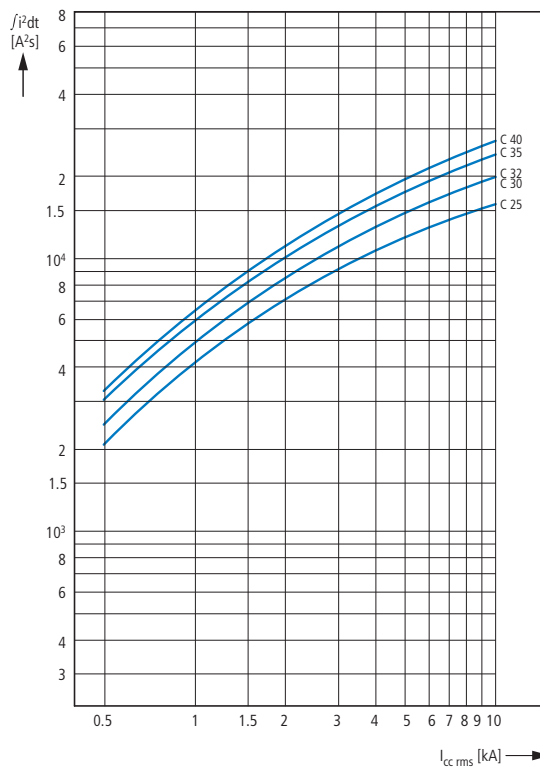

Characteristic D (0.5 - 20 A), 277 V

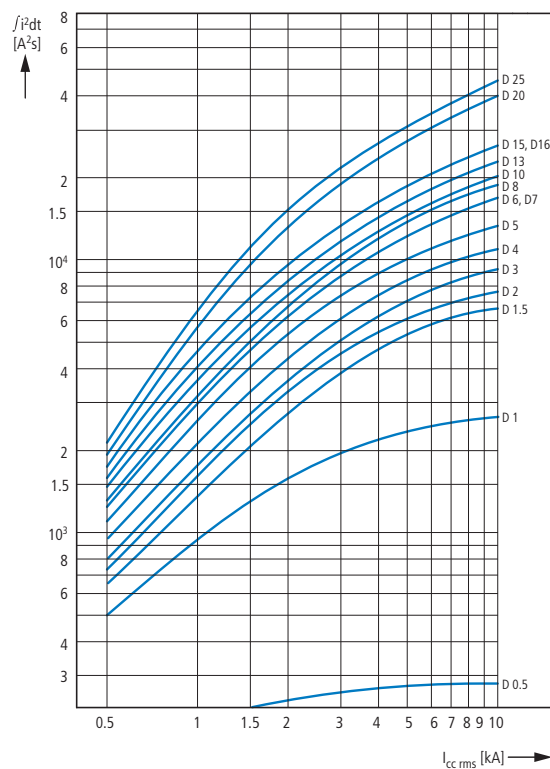

Characteristic D (25 - 40 A), 240 V

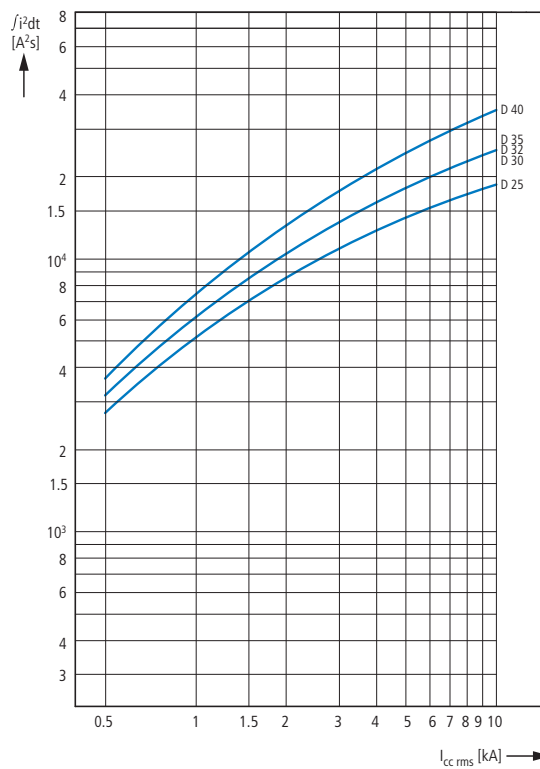

info@tm2a.pt

WWW.TM2A.PT

info@tm2a.pt

WWW.TM2A.PT



Fuse links

Z-DO.../S...

Let-through current

Time/current characteristics

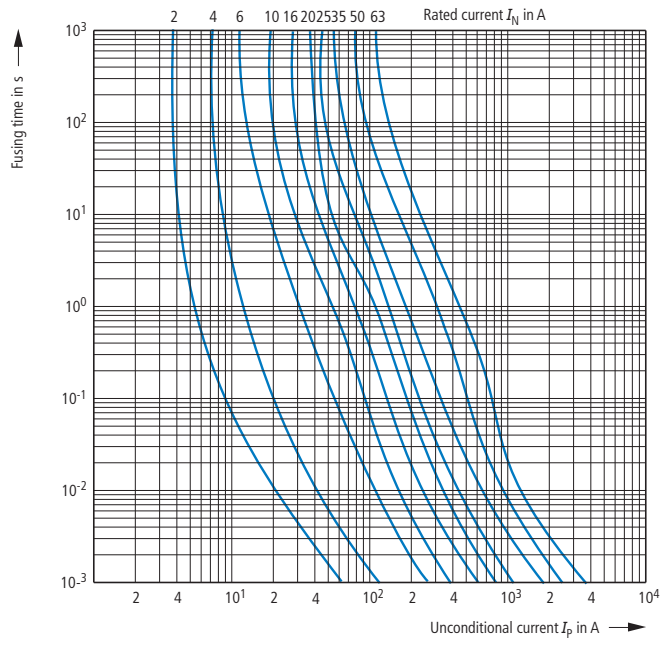
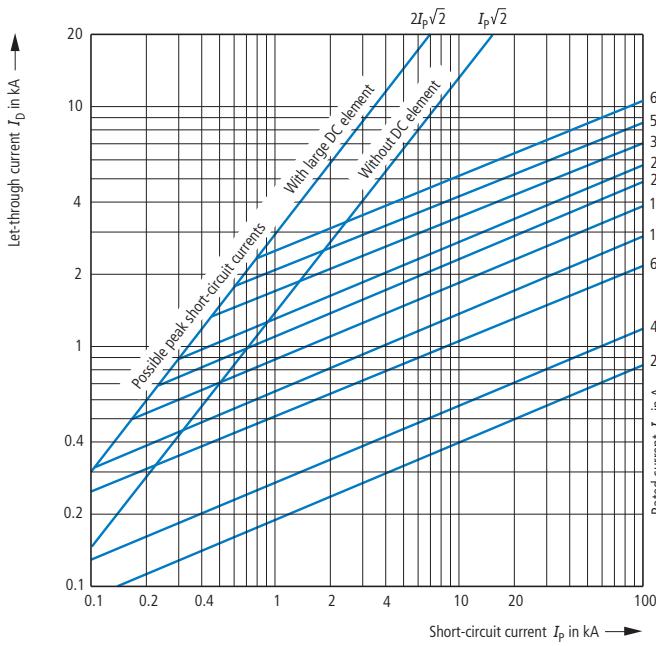

LV h.b.c. fuse links

Z-NH...

Let-through current

Time/current characteristics

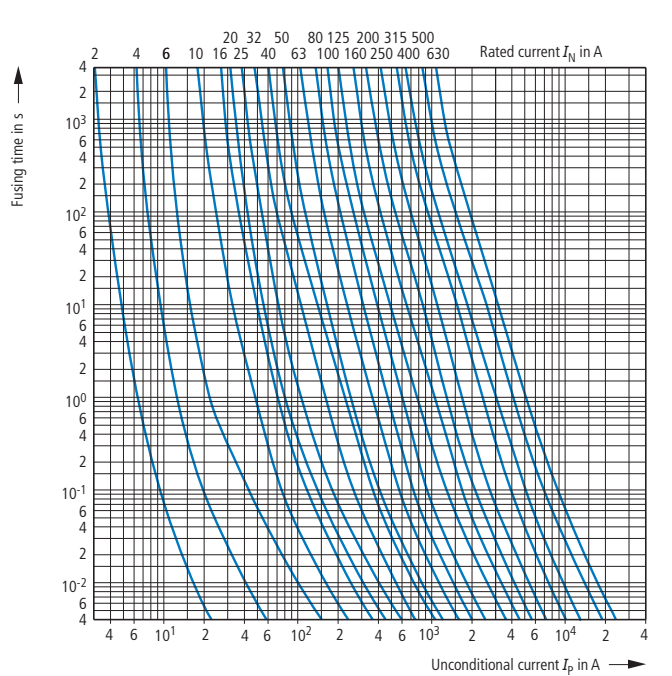
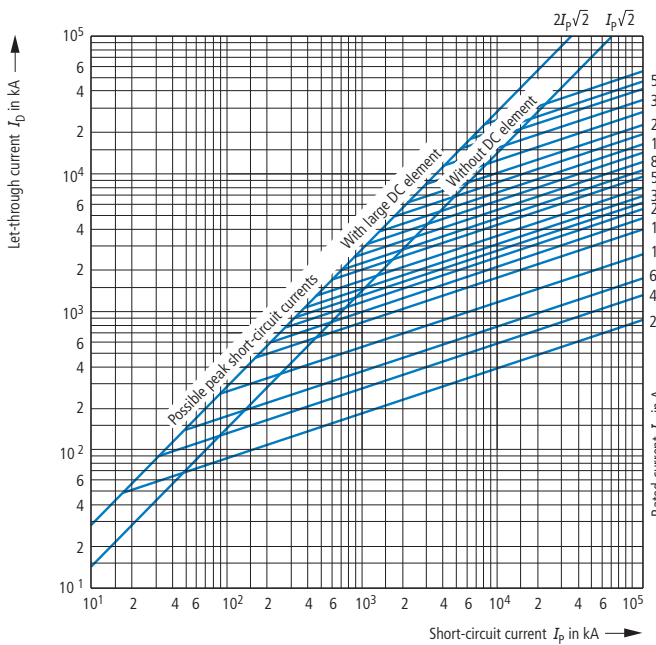

info@tm2a.pt

WWW.TM2A.PT

info@tm2a.pt

WWW.TM2A.PT



## Technical data

			FAZ	FAZ-...-DC	FAZ-PN	AZ
<b>Electrical</b>						
Standards			IEC/EN 60947-2 IEC/EN 60898	IEC/EN 60947-2	IEC/EN 60898	IEC/EN 60947-2
Rated operating voltage	V AC		230/400	-	230	230/400
	V DC		48 (per pole)	250 (per pole)	48 (per pole)	60 (per pole)
Rated switching capacity	kA		15	10	6	25
Operational switching capacity	kA		7.5	-	-	20
Characteristic			B, C, D, K, S, Z	C	B, C	Similar: D, C
Max. back-up fuse	A gL/gG		125	100	100	200
Selectivity class			3	3	3	Compliant with Class 3
Lifespan	Operations		> 10000	> 10000	> 4000	> 10000
Direction of incoming supply			Any	Polarized	Any	Any
<b>Mechanical</b>						
Standard front dimension	mm		45			
Device height	mm		80	80	80	90
Terminal protection			Finger and back-of-hand proof to BGV A2			
Mounting width per pole	mm		17.5	17.5	17.5	27
Mounting			Top-hat rail to IEC/EN 60715			
Protection type			IP20, IP40 (enclosed)			
Terminals top and bottom			Twin-purpose terminals			Lift terminals
Terminal capacity	Solid	mm <sup>2</sup>	1 x 25	1 x 25	1 x 16	2.5 - 50
	Flexible	mm <sup>2</sup>	2 x 10	2 x 10	-	-
Thickness of busbar material	mm		0.8 - 2	0.8 - 2	-	-
Mounting position			Any		-	-
<b>FAZT</b>						
<b>Electrical</b>						
Standards			IEC/EN 60947-2			
Rated voltage	V AC		240/415			
	V DC		60 V per pole; up to two poles in series			
Rated frequency	<i>f</i>	Hz	50/60			
Rated switching capacity	B, C (to 13 kA); D (to 10 kA)	kA	25			
	B, C (16-25 kA); D (12-16 kA)	kA	20			
Characteristic			B, C, D			
Lifespan	Operations		20000			
Direction of incoming supply			Any			
<b>Mechanical</b>						
Standard front dimension	mm		45			
Device height	mm		80			
Mounting width per pole	mm		17.5			
Mounting			Quick attachment with three engagement positions for top-hat rail to IEC/EN 60715			
Protection type			IP20			
Terminals top and bottom			Twin-purpose terminals			
Terminal protection			Finger and back-of-hand proof to BGV A3, ÖVE-EN 6			
Terminal capacity	mm <sup>2</sup>		1 - 25			
Tightening torque	Nm		2 - 2.4			
Thickness of busbar material	mm		0.8 - 2 (except N 0.5 space unit)			
Mounting position			Any			



			PKNM	FIM	AZFIMP	FI ≤ 100 A	FI 125 A and Type B
<b>Electrical</b>							
Standards and regulations			IEC/EN 61009	IEC/EN 61009	IEC/EN 60947-2	IEC/EN 61008	IEC/EN 61008
Tripping		A	250 (8/20 μ) non-delayed surge resistant			Non-delayed, S	
Rated operational voltage	$U_e$	V AC	230	230/400	230/400	230/400	230/400
Operating limit values		V AC	196 - 253	196 - 440	196 - 440	184 - 440	184 - 440
Rated frequency	$f$	Hz	50				
Rated fault currents	$I_{\Delta n}$	mA	30, 300	30, 300	30, 300	30, 100, 300, 500	30, 100, 300, 500
Rated non-tripping current			$0.5 \times I_{\Delta n}$	$0.5 \times I_{\Delta n}$	$0.5 \times I_{\Delta n}$	$0.5 \times I_{\Delta n}$	$0.5 \times I_{\Delta n}$
Rated fault switching capacity	$I_{\Delta n}$	A	-	-	-	$I_n = 16-40$ A: 500 $I_n = 63$ A: 630 $I_n = 80$ A: 800 $I_n = 100$ A: 1000	$I_n = 125$ A: 1250 for type B: 60, 80 A: 800 40 A: 500 125 A: 1250
	230 V	kA	6	-	-	-	-
	400 V	kA	3	-	-	-	-
Sensitivity			DC and pulsed current				Pulsed current and AC/DC
Rated switching capacity	$I_{cn}$	kA	10	As fitted FAZ	As fitted AZ	10	10
Operational switching capacity	$I_{cs}$	kA	-	As fitted FAZ	-	-	-
Rated ultimate breaking capacity	$I_{cu}$		-	As fitted AZ	As fitted AZ	-	-
Rated short-circuit switching capacity			-	-	= $I_{cu}$	-	-
Rated operational current	$I_e$	A	6 - 40	40, 63	80, 125	16 - 100	40 - 125
Rated impulse withstand voltage	$U_{imp}$	kV	6 (1.2/50 μs)	-	4 (1.2/50 μs)	6	6
Characteristic			B, C	-	-	-	-
Maximum back-up fuse as short-circuit protective device		A gL	100	-	-	$I_n = 16 - 63$ A: 63 $I_n = 80$ A: 80 $I_n = 100$ A: 100	$I_n = 125$ A: 125 for type B: $I_n \leq 80$ : 100 $I_n = 125$ : 125
Selectivity class			3	-	-	-	-
Lifespan							
Electrical	Operations		> 4000	-	> 1500	> 4000	> 2000
Mechanical	Operations		-	-	> 10000	> 20000	> 5000
<b>Mechanical</b>							
Standard front dimension	mm		45	45	45	45	45
Device height	mm		80	90	90	80	85
Terminal protection			Busbar tag shroud to BGV A2				
Mounting width	mm		35 (2 SU)	70 (2 pole), 125 (4 pole)	95 (5.5 SU)	35 (2 space unit), 70 (4 space units)	70 (4 SU)
Mounting			-	Permanently screw-connected to FAZ	Screwed on to AZ (2 to 4 pole)	IEC/EN 60715 top-hat rail	IEC/EN 60715 top-hat rail
Protection type							
Circuit-breaker			IP20	-	-	-	-
Enclosed			IP40	IP40	IP40	IP40	IP40
Terminals top and bottom			Twin-purpose terminals	Lift terminals	Lift terminals	Twin-purpose terminals	Twin-purpose terminals
Terminal capacity							
Solid	mm <sup>2</sup>		1 x 25	1 x (1 - 25)	2.5 - 50	1.5 - 35	1.5 - 50
Flexible	mm <sup>2</sup>		-	1 x (0.75 - 16)	-	2 x 16	2 x (1.5 - 16)
Thickness of busbar material	mm		0.8 - 2	0.8 - 2	-	0.8 - 2	0.8 - 2
Admissible ambient temperature range	°C		-25 - +40	-25 - +40	-25 - +40	-25 - +40	-25 - +40
Climatic proofing			IEC/EN 61009	IEC/EN 61009	IEC/EN 60068-2	IEC/EN 61008	IEC/EN 61008



			mRB6...	mRB4...
<b>Electrical</b>				
Standards			IEC/EN 61009	IEC/EN 61009
Tripping		A	250 (8/20 $\mu$ ) non-delayed surge resistant	
Rated operating voltage	$U_e$	V AC	230/400	230/400
Rated frequency	$f$	Hz	50	50
Rated fault currents	$I_{\Delta n}$	mA	30, 100, 300	30, 100, 300
Rated fault non-tripping current			$0.5 \times I_{\Delta n}$	$0.5 \times I_{\Delta n}$
Sensitivity			DC and pulsed current	
Rated switching capacity	$I_{cn}$	kA	6	4.5
Rated operational current	$I_e$	A	6 - 25	6 - 25
Rated impulse withstand voltage	$U_{imp}$	kV	4 (1.2/50 $\mu$ s)	4 (1.2/50 $\mu$ s)
Characteristic			B, C, D	C, D
Maximum back-up fuse as short-circuit protective device		A gL	100	100
Selectivity class			3	3
Lifespan				
Electrical		Operations	> 4000	> 4000
Mechanical		Operations	> 20000	> 20000
<b>Mechanical</b>				
Standard front dimension		mm	45	45
Device height		mm	80	80
Terminal protection			Busbar tag shroud to VBG4	
Mounting width		mm	70 (4 SU)	70 (4 SU)
Mounting			Tristable slide catch allows removal from an existing assembly.	
Protection type				
Circuit-breaker			IP20	IP20
Enclosed			IP40	IP40
Terminals top and bottom			Twin-purpose terminals	Twin-purpose terminals
Terminal capacity				
Solid		mm <sup>2</sup>	1 - 25	1 - 25
Thickness of busbar material		mm	0.8 - 2	0.8 - 2
Admissible ambient temperature range		°C	-25 - +40	-25 - +40
Climatic proofing			According to IEC 68-2 (25 – 55 °C, 90 – 95 % rel. humidity)	
<b>Z-CC/2CO</b>				
<b>Electrical</b>				
Power supply		VDC	12 - 24 ( $\geq 10 - \leq 30$ )	
Power consumption		W	1.5 - 6	
Temperature sensor			Incl. 9 pole Sub-D plug (for RS232 interface) Measurement range -10 °C – +50 °C, accuracy: $\pm 2$ °C	
Outputs			2 floating relay outputs AC: 5 A at 250 AC DC: 5 A at 30 V DC, 0.3 A at 110 V DC and 0.12 A at 220 V DC Max. switching duty AC15 at 230 V DC: 500 VA	
Inputs			4; max. 12 – 24 V DC (2 – 4 mA) isolated (optocoupler)	
Ethernet interface			Required for parameterization with a PC (web browser). For connecting PC and Z-CC/2CO a crossover network cable is required (DNW-PX/0200/RJ45/RJ45).	
RS232 interface			9 pole Sub-D plug for connecting an external temperature sensor	
Green LED ON			Modem status LED (on registration in the GSM network the LED flashes every 3 seconds)	
Red LED ON			Modem activity LED (flashes when SMS is being sent or received)	
<b>Mechanical</b>				
Standard front dimension		mm	45	
Device height		mm	97	
Mounting width		mm	105	
Mounting			Quick attachment for top-hat rail EN 50022	
Protection type				
Enclosed			IP40	



			dRCM...
<b>Electrical</b>			
Standards and regulations			IEC/EN 61008, Type G and G/A to ÖVE E 8601 Current approvals as labeled
Tripping			Non-delayed
Type G, R			10 ms delayed
Type S			40 ms delay - selective switch off
Type U (only 30 mA)			10 ms delayed
Type U (except 30 mA)			40 ms delay - selective switch off
Rated voltage	$U_n$	V AC	230/400, 240/415
Rated frequency	$f$	Hz	50/60
Operational voltage electronic		V AC	50 - 254
Operational voltage test circuit		V AC	184 - 440
Rated fault currents	$I_{\Delta n}$	mA	30, 300
Sensitivity			DC and pulsed current
Rated insulation voltage	$U_i$	V	440
Rated impulse withstand voltage	$U_{imp}$	kV	4 (1.2/50 $\mu$ s)
Rated short-circuit strength	$I_{nc}$	kA	10
Surge current capacity			
Type G, G/A, R, U (30 mA)		kA	3 (8/20 $\mu$ s) surge-proof
Type S/A, U (except 30 mA)		kA	Part no. 5 (8/20 $\mu$ s) selective and surge-proof
Electrical isolation			> 4 mm contact spacing
Max. admissible back-up fuse			Short-circuit and overload
$I_n = 16 - 63$ A		A gG/gL	63
$I_n = 80$ A		A gG/gL	80
$I_n = 100$ A		A gG/gL	100
Lifespan			
Electrical		Operations	$\geq 4000$
Mechanical		Operations	$\geq 20000$
<b>Mechanical</b>			
Standard front dimension		mm	45
Device height		mm	80
Mounting width		mm	70 (4 SU)
Mounting			Quick attachment with two engagement positions for top-hat rail to IEC/EN 60715
Protection type			
Enclosed			IP40
In moisture-proof enclosure			IP54
Terminals top and bottom			Twin-purpose terminals
Terminal protection			Busbar tag shroud to BGV A3
Terminal capacity			
Solid		mm <sup>2</sup>	1 - 35
Stranded		mm <sup>2</sup>	2 x 16
Terminal screws			M5 (Pozidriv PZ2)
Tightening torque terminal screws		Nm	2 - 2.4
Thickness of busbar material		mm	0.8 - 2
Admissible ambient temperature range		°C	-25 - +40
Climatic proofing			According to IEC/EN 61008



			PDIM
<b>Electrical</b>			
Standards			Conforming with DIN/EN 62020
Rated operational current	$I_e$	A	40, 100
Response behavior (adjustable)			Non-delayed
Type G			10 ms delayed
Type S			40 ms delayed - selective
Rated operating voltage	$U_e$	V AC	230/400 50/60 Hz 240/415 50/60 Hz
Rated fault currents	$I_{\Delta n}$	mA	30, 100, 300, 500, 1000
Sensitivity			Alternating and pulsed current
Rated insulation voltage	$U_i$	V	440
Rated short-circuit strength	$I_{nc}$	kA	10
Max. admissible back-up fuse			
$I_n = 40$ A		A gG/gL	Short-circuit: 63 overload: 40
$I_n = 100$ A		A gG/gL	Short-circuit: 100 A Overload: 63 A
Switching contacts			Potential-free 10 A / 230 ~
Response behavior of contacts			1: 30 - 50 % $I_{\Delta n}$ 2: > 50 % $I_{\Delta n}$
Lifespan			
Electrical		Operations	$\geq 4000$
Mechanical		Operations	$\geq 20000$
<b>Mechanical</b>			
Standard front dimension		mm	45
Device height		mm	80
Mounting width		mm	70 (4 SU)
Mounting position			Any
Mounting			Quick attachment with two engagement positions for top-hat rail to IEC/EN 60715
Protection type			
Enclosed			IP40
Protection type In moisture-proof enclosure			IP54
Terminals top and bottom			Twin-purpose terminals
Terminal protection			Busbar tag shroud to BGV A3, ÖVE-EN 6
Terminal capacity (1, 2, 3, 4, 5, 6, N, N)			
Solid		mm <sup>2</sup>	1.5 - 35
Stranded		mm <sup>2</sup>	2 x 16
Terminal cross-section of switching contacts		mm <sup>2</sup>	0.25 - 1.5
Thickness of busbar material		mm	0.8 - 2
Admissible ambient temperature range		°C	-25 to +40
Climatic proofing			According to IEC/EN 61008



			FAZ-XHIN11	FAZ-XHINW1	FAZ-XAM002	FAZ-XAA-C	FAZ-XUA
<b>Electrical</b>							
Rated operating voltage	$U_e$	V AC	250	250	250	-	115, 230, 400
Contact function			1 N/O + 1 NC	1 C	2 C	-	-
Voltage range		V AC	-	-	-	12 - 110 110 - 415	-
Closing threshold	$x U_n$		-	-	-	-	0.8
Tripping threshold	$x U_n$		-	-	-	-	0.5
Rated frequency	$f$	Hz	50/60	50/60	50/60	50/60	50/60
Rated operational current	$I_e$	A	6	6	4	-	-
Thermal rated operational current	$I_{th}$	A	6	6	4	-	-
Rated operational current							
AC-12	$I_e$	A	3 (250 V AC)	3 (250 V AC)	3 (250 V AC)	-	-
AC-15	$I_e$	A	2 (250 V AC)	2 (250 V AC)	2 (250 V AC)	-	-
DC-13	$I_e$	A	0.5 (110 V DC)	0.5 (110 V DC)	0.5 (110 V DC)	-	-
Rated insulation voltage	$U_i$	V AC	250	250	250	-	-
Minimum operating voltage per contact	$U_{min}$	V DC	5	5	5	-	-
Rated impulse withstand voltage (1.2/ 50 $\mu$ )	$U_{imp}$	kV	2.5	2.5	2.5	-	-
Rated conditional short-circuit current with 6 A back-up fuse	$I_k$	kA	1	1	1	-	-
Max. admissible back-up fuse		A gL	6	6	4		
<b>Mechanical</b>							
Standard front dimension		mm	45	45	45	45	45
Device height		mm	80	80	80	80	80
Mounting width		mm	8.8 (0.5 SU)	8.8 (0.5 SU)	8.8 (0.5 SU)	17.5 (1 SU)	17.5 (1 SU)
Mounting			Max. 2 $\times$ on switching device	Max. 2 $\times$ on switching device	On switching device	IEC/EN 60715 top-hat rail	IEC/EN 60715 top-hat rail
Protection type							
Enclosed			IP40				
Terminal protection			Busbar tag shroud to BGV A2				
Terminals			Lift terminals	Lift terminals	Lift terminals	Twin-purpose terminals	Twin-purpose terminals
Terminal capacity							
Solid		mm <sup>2</sup>	0.5 - 2.5	0.5 - 2.5	0.5 - 2.5	1 - 2.5	2 x (1 - 2.5)
Flexible		mm <sup>2</sup>	0.5 - 2.5	0.5 - 2.5	0.5 - 2.5	1 - 2.5	2 x (1 - 2.5)
Tightening torque of terminal screws		Nm	$\leq 1.2$	$\leq 1.2$	0.8 - 1.0	2.4	0.8



				AZ-XHI11	AZ-XAA	FI-XHI11 ≤ 100 A	FIPA-XAM011 125 A FI and Type B
<b>Electrical</b>							
Contact function				1 N/O + 1 NC	-	1 N/O + 1 NC	1 C/O + 1 NC
Voltage range		V AC		-	12 - 110 110 - 415	-	-
Voltage range		V DC		-	12 - 60 110 - 220	-	-
Min. operating voltage	$U_e$	V/mA		24/50	-	24/50	12/100
Rated operational current							
AC-11							
	230 V	$I_e$	A	6	-	6	6
AC-13							
	250 V	$I_e$	A	6	-	6	-
	400 V	$I_e$	A	2	-	2	-
DC-11							
	230 V	$I_e$	A	4	-	-	1
DC-13							
	60 V	$I_e$	A	4	-	4	-
	110 V	$I_e$	A	2	-	2	-
	230 V	$I_e$	A	0.5	-	0.5	-
Rated insulation voltage	$U_i$	V AC		440	440	440	440
Minimum operating voltage per contact	$U_{min}$	V DC		-	-	-	-
Rated impulse withstand voltage	$U_{imp}$	kV		-	-	-	-
Rated conditional short-circuit current with 6 A back-up fuse	$I_k$	kA		-	-	-	-
Max. admissible back-up fuse		A gL		6	Inherently short-circuit-proof	6	6
Lifespan							
Mechanical			Operations	> 6000	> 4000	> 6000	-
Inrush current							
AC			A	-	38	-	-
Duty factor AC			ms	-	2.1	-	-
DC			A	-	34	-	-
Duty factor DC			ms	-	2	-	-
<b>Mechanical</b>							
Standard front dimension		mm		45	45	45	45
Device height		mm		90	90	90	90
Mounting width		mm		8.8 (0.5 SU)	17.5 (1 SU)	8.8 (0.5 SU)	8.8 (0.5 SU)
Mounting				Top-hat rail to IEC/EN 60715			
Protection type							
Enclosed				IP40			
Circuit-breaker				IP20			
Terminal capacity							
Solid			mm <sup>2</sup>	1 x (1 - 25) 2 x (1 - 4)	1 x (1 - 25) 2 x (1 - 4)	2 x (0.5 - 2.5) 1 x (0.5 - 2.5)	1 x 2.5 2 x 1.5
Flexible			mm <sup>2</sup>	1 x (1 - 25) 2 x (1 - 4)	1 x (1 - 25) 2 x (1 - 4)	2 x (0.5 - 2.5) 1 x (0.5 - 2.5)	1 x 2.5 2 x 1.5
Tightening torque of the terminal screws		Nm		0.8	3	0.8	0.8



			KWZ-3PH	KWZ-3PH-65
<b>Electrical</b>				
Rated operating voltage	$U_e$	V AC	230 - 240/400-415	
Voltage range		V AC	110 - 254/190-440	
Rated operational current	$I_e$	A	1, 5	10
Max. current	$I_{max}$	A	6	63
Rated frequency	$f$	Hz	50, 60	
Limiting frequency		Hz	47 - 63	
Own consumption per phase (current path)		VA	$\leq 0.5$ (each phase)	$\leq 4$ (each phase)
Overload, short-term			$20 \times I_{max} / 0.5$ s	$30 \times I_{max} / 10$ ms
Auxilliary voltage			From measurement	
Input signal			Sine-shaped	
Accuracy class			1	
LED signal			1 pulse / 0.1 Wh	1 pulse / Wh
Pulse output				
Rated value			Max. 110 V AC/DC, 50 mA	
Switching contact (potential-free)			Optocoupler	
Pulse value (selectable)			1 pulse / 10 Wh, 100 Wh, 1 kWh, 10 kWh optional 1 Imp. / 10 VARh, 100 VARh, 1 kVARh, 10 kVARh	1 pulse / 1 Wh, 10 - 100 Wh, 1 kWh, 10 kWh optional 1 Imp. / 10 VARh, 100 VARh, 1 kVARh, 10 kVARh
Pulse duration (selectable)		ms	50, 100, 150, 200, 300, 400, 500	
Programmable parameters			Network types (single-phase, 3-phase, 3- or 4-conductor), External current and voltage transformers, mean performance, pulse output	Network types (3-phase, 3- or 4-conductor), Partial energy and double tariff, mean performance, pulse output
Overvoltage category			III	
Insulation voltage (phase - phase)		V	450	300
Rated impulse withstand voltage (1.2/50) $\mu$ s		kV	5	
Test voltage				
Input/pulse output		kV	2.75	
All circuits and ground		kV	4	
Protection class			II	
<b>Mechanical</b>				
Standard front dimension		mm	45	
Device height		mm	89	
Mounting width		mm	71.2	
Weight		g	260	
Display			LCD 8 digit	
Digit height		mm	6	
Maximum display			Adjustable	999999.99 kWh
Resolution			Adjustable	10 W
Measurement display			arranged into 6 pages	arranged into 7 pages
Mounting			Quick attachment for top-hat rail IEC/EN 60715	
Protection type device front/ terminals			IP52/IP20	
Terminals top and bottom			Screw terminals	
Terminal capacities				
Current connections				
Solid		mm <sup>2</sup>	0.05 - 4	1 - 10
Stranded		mm <sup>2</sup>	0.05 - 2.5	1 - 13
Voltage connections				
Solid		mm <sup>2</sup>	0.05 - 4	1 - 4
Stranded		mm <sup>2</sup>	0.05 - 2.5	1 - 3
Admissible relative humidity			Also suitable for tropical conditions	
Reference temperature		°C	23 $\pm$ 2	
Temperature range		°C	-5 - +55	
Storage and transportation temperature range		°C	-25 - +70	
Pollution degree			2	



				FAZ/FIP-XAWM	FAZ/FIP-XDWM
<b>Electrical</b>					
Operating voltage range					
V AC				220 - 240	-
V DC				-	48
Rated frequency		f	Hz	50/60	-
Relay output for alarm, 250 V AC, floating			A	5	5
Function				Automatic control	
Function selector				Automatic 5 ×, OFF/RESET	
<b>Mechanical</b>					
Standard front dimension			mm	45	45
Device height			mm	80	80
Mounting width			mm	70	70
Mounting				Top-hat rail to IEC/EN 60715	
Protection type					
Enclosed				IP40	
Terminal protection				Busbar tag shroud to BGV A2	
Terminals				Lift terminals	
Terminal capacity					
Solid			mm <sup>2</sup>	2 x 1.5 1 x 2.5	2 x 1.5 1 x 2.5
Flexible			mm <sup>2</sup>	2 x 1.5 1 x 2.5	2 x 1.5 1 x 2.5

				FAZ-...-NA	FAZ-...-RT
<b>Electrical</b>					
Standards				UL 489, CSA C22.2 No.5, IEC 60947-2	
Rated operating voltage					
UL/CSA 0.5 - 25 A			V AC	277/480 Y	
UL/CSA 32 - 40 A			V AC	240	
UL/CSA (per pole)			V DC	48	
IEC			V AC	240/415	
Rated frequency		f	Hz	50/60	
Rated breaking capacity					
IEC				kA	
15				15	
Characteristic				B, C, D	
Lifespan				Operations	
> 20000				> 20000	
Mains voltage connection				Any (top/bottom)	
<b>Mechanical</b>					
Standard front dimension			mm	45	
Device height			mm	105	
Mounting width per pole			mm	17.7	
Mounting				Quick attachment with two engagement positions for top-hat rail to IEC/EN 60715	
Terminals top and bottom				Twin-purpose terminals	
Terminal capacity					
Solid			AWG	18 - 6	
Flexible			AWG	18 - 10	
Mounting position				Any	
Calibration temperature					
UL 489, CSA C22.2 No. 5			°C	40	
IEC 60947-2			°C	30	

WWW.TM2A.PT info@tm2a.pt

WWW.TM2A.PT info@tm2a.pt

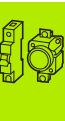



			Z-NHK	Z-IHK-NA
<b>Electrical</b>				
Standards			IEC/EN 60947-5-1, IEC/EN 62019	IEC/EN 60947-5-1, IEC/EN 62019
Rated voltage		V AC	230	250
Contact function			2 C	1 N/O + 1 NC
Rated frequency	f	Hz	50/60	50/60
Rated operational current	$I_e$	A	2	6
Thermal rated operational current	$I_{th}$	A	2	6
Rated operational current				
AC-13	$I_e$	A	3 (250 V AC)	3 (250 V AC)
AC-15	$I_e$	A	2 (250 V AC)	2 (250 V AC)
DC-12	$I_e$	A	0.5 (110 V DC)	0.5 (110 V DC)
Rated insulation voltage	$U_i$	V AC	250	250
Minimum operating voltage per contact	$U_{min}$	V DC	5	5
Minimum operating current	$I_{min}$	mA	10 (DC)	10 (AC/DC)
Rated impulse withstand voltage (1.2/ 50 $\mu$ )	$U_{imp}$	kV	2.5	4
Rated conditional short-circuit current with 6 A back-up fuse	$I_k$	kA	1	1
Max. admissible back-up fuse		A gL	6	
<b>Mechanical</b>				
Standard front dimension		mm	45	45
Device height		mm	80	80
Mounting width		mm	8.8 (0.5 SU)	8.8 (0.5 SU)
Mounting			For fitting to left side of FAZ-...-NA, FAZ-...-RT, FAZ-XAA-NA...	-
Protection type				
Enclosed			IP40	IP40
Terminal protection			Busbar tag shroud to BGV A3	Busbar tag shroud to BGV A3
Terminals			Lift terminals	Lift terminals
Terminal capacity				
		AWG	20 - 14	-
		mm <sup>2</sup>		0.5 - 2.5
Terminal screws			M3 (Pozidriv Z0)	M3 (Pozidriv Z0)
Tightening torque of the terminal screws		Nm	-	$\leq 1.2$
			<b>FAZ-XAA-NA12-110VAC</b>	<b>FAZ-XAA-NA110-415VAC</b>
<b>Electrical</b>				
Voltage range		V AC	12 - 110	110 - 415
		V DC	12 - 60	110 - 230
Rated frequency	f	Hz	50/60	50/60
<b>Mechanical</b>				
Standard front dimension		mm	45	45
Device height		mm	105	105
Mounting width		mm	17.5	17.5
Mounting			Quick attachment with two engagement positions for top-hat rail to EN 50022	Quick attachment with two engagement positions for top-hat rail to EN 50022
Protection type				
Enclosed			IP40	IP40
Terminal protection			Busbar tag shroud to BGV A3	Busbar tag shroud to BGV A3
Terminals top and bottom			Twin-purpose terminals	Twin-purpose terminals
Terminal capacity				
Solid		AWG	18 - 10	18 - 10
Two-wire		AWG	18 - 10	18 - 10

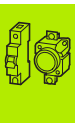

## Z-NH-..., Z-SLS/B, Z-DO

			Z-NH-...	Z-NH-1/	Z-NH-2/	Z-NH-2/
<b>Electrical</b>						
Standards			IEC 60269, VDE 0636, SEV 1086			
Nominal voltage						
AC		V AC	500	500	500	500
DC		V DC	230	440	440	440
Rated operational current			10 - 160	50 - 250	100 - 400	250 - 630
Rated frequency			f	45 - 62	45 - 62	45 - 62
Rated breaking capacity						
AC		kA	120	120	120	120
DC		kA	25	25	25	25
Max. heat dissipation						
$I_n = 10$ A		W	1.1	-	-	-
$I_n = 16$ A		W	1.6	-	-	-
$I_n = 20$ A		W	1.7	-	-	-
$I_n = 25$ A		W	1.9	-	-	-
$I_n = 35$ A		W	3.0	-	-	-
$I_n = 40$ A		W	3.5	-	-	-
$I_n = 50$ A		W	4.6	5.4	-	-
$I_n = 63$ A		W	5.4	6.3	-	-
$I_n = 80$ A		W	5.1	7.2	-	-
$I_n = 100$ A		W	6.9	8.6	8.8	-
$I_n = 125$ A		W	10.3	11.9	12.1	-
$I_n = 160$ A		W	11.0	13.9	14.0	-
$I_n = 200$ A		W	-	15.2	15.2	-
$I_n = 250$ A		W	-	21.8	21.8	19.4
$I_n = 315$ A		W	-	-	23.7	23.7
$I_n = 400$ A		W	-	-	30.5	30.5
$I_n = 500$ A		W	-	-	-	42.0
$I_n = 630$ A		W	-	-	-	47.0

			Z-SLS/B	Z-SLS/B24
<b>Electrical</b>				
Rated operating voltage				
Rated operating voltage	$U_e$	V AC	60 - 400	24 - 60
		V DC	60 - 220	24 - 60
Utilization category			gG (gL)	gG (gL)
Test voltage			kV	5
<b>Mechanical</b>				
Size			D01: 1, 2, 4, 6, 10, 13, 16 A D02: 20, 25, 32, 35, 40, 50, 63 A	

			Z-DO/SE
<b>Electrical</b>			
Standards			DIN VDE 0636, DIN 49522
Utilization category			gG (gL)
Rated voltage			
AC	$U_n$	V	400
DC	$U_n$	V	220
Rated frequency			f
			45 - 65
Rated insulation voltage			$U_i$
			2500
Rated short-circuit switching capacity			
AC		kA	50
DC		kA	8



				D01-S0/	D02-S0/
<b>Electrical</b>					
Number of poles				1P 3P	1P 3P
Rated operating voltage		V AC		400	400
		V DC		250	250
Rated conditional short-circuit current tested with links	$I_e$	kA		50 (AC) / 8 (DC)	50 (AC) / 8 (DC)
Rated frequency	f	Hz		-	-
Rated operational current	$I_e$	A		16	63
Conventional thermal current with fuse links	$I_{th}$	A		-	-
Rated operating mode				-	-
Overvoltage category				-	-
Utilization category				-	-
Rated impulse withstand voltage	$U_{imp}$	kV		-	-
Current heat loss per contact at $I_e$		W		-	-
Heat dissipation					
Heat dissipation per contact with fuse link at $I_e$		W		-	-
Max. permissible heat dissipation of the fuse links		W		-	-
Utilization category				gG (gL)	gG (gL)
<b>Mechanical</b>					
Standard front dimension		mm		45	45
Device height		mm		68	68
Mounting width		mm		27 (per pole)	27 (per pole)
Weight		g		1P 76 3P 230	1P 76 3P 230
Electrical thread				E14	E18
Mounting				Quick attachment for top-hat rail IEC/EN 60715	
Protection type					
Enclosed				-	-
Terminals				Double function terminals	
Terminal capacity					
Solid		mm <sup>2</sup>		1.5 - 35	1.5 - 35
Temperature range		°C		-	-
Terminal screw tightening torque		Nm		2.5 - 3	2.5 - 3
Pollution degree				-	-
Track resistance				CTI 200	CTI 200
<b>Z-DII-/SE</b>					
<b>Electrical</b>					
Standards				DIN EN 60269-1 (VDE 0636 part 10), DIN EN 60269-3 (VDE 0636 part 30), DIN VDE 0636-301, CEE 16, IEC/EN 60269-1, IEC/EN 60269-3	
Utilization category				gG (gL), DZ	
Rated voltage					
	AC	$U_n$	V	500	
DC	$U_n$	V	400		
Rated frequency	f	Hz		45 - 65	
Insulation class				C-VDE0110	
Rated short-circuit breaking capacity at 1.1 x $U_n$					
	AC		kA	50/cosφ = 0.2	
DC		kA		8/τ = 15 ms	



			Z-SLS/NE0Z	Z-SLK/NE0Z
<b>Electrical</b>				
Number of poles			1P 1P+N 2P 3P 3P+N	1P 1P+N 2P 3P 3P+N
Rated operating voltage		V DC	1P up to 110V / 2P up to 220V	
Rated operating voltage		V AC	400	400
Rated operational current	$I_e$	A	63	63
Rated uninterrupted current	$I_u$	A	63	63
Rated short-circuit making capacity			50 kArms	50 kArms
Normally open contact			-	5A/250V
Switching category			AC 22 B, DC 21 B	AC 22 B, DC 21 B
Overvoltage category			IV	IV
Rated impulse withstand voltage	$U_{imp}$	kV	6	6
Current heat loss per current path at $I_e$		W	0.5	0.5
Heat dissipation				
Heat dissipation per contact with fuse link at $I_e$		W	7.5	7.5
<b>Relay section electrical</b>				
Operating voltage range		V AC	-	24 - 240
Operational voltage tolerance			-	±10%
Power consumption		VA	-	5
Frequency		Hz	-	50-60
Function display			-	Mains: 1 LED Fault: 1 LED
Duty factor		%	-	100
Response delay		ms	-	Approx. 100
Recovery time	$t_w$	ms	-	Approx. 100
Relay contacts			-	2 changeover contacts, 5A/250V
Overvoltage category			-	III
Auxiliary contacts				
Rated impulse withstand voltage	$U_{imp}$	kV	-	4
<b>Mechanical</b>				
Standard front dimension		mm	45	45
Device height		mm	86	86
Mounting width		mm	27/per pole (1.5 SU)	27/per pole (1.5SU) + 27
Weight		g	1P 113 1P+N 225 2P 224 3P 450 3P+N 472	1P 224 2P 345 3P 450 3P+N 472
Mounting			Quick attachment for top-hat rail IEC/EN 60715	
Protection type in fitted state			IP20	IP20
Terminals			Lift terminals	Lift terminals
Terminal capacity				
Solid		mm <sup>2</sup>	1.5 - 35	1.5 - 35
Temperature range		°C	-25 ... +60	-25 ... +60
Flammability classification to EN 60730			V0, glow-wire test 960°C	
Terminal screw tightening torque		Nm	Max. 4.5	Max. 4.5
Pollution degree			3	3
Track resistance			CTI 600	CTI 600
<b>Relay section mechanical</b>				
Terminals			Lift terminals	Lift terminals
Terminal capacity				
Solid		mm <sup>2</sup>	-	0.14 - 4
Flexible		mm <sup>2</sup>	-	0.14 - 2.5
Terminal screw tightening torque		Nm		0.5 - 0.7



			VLC14	VLC22	
<b>Electrical</b>					
Number of poles			1P 1P+N 2P 3P 3P+N	1P 1P+N 2P 3P 3P+N	
Rated operating voltage		V AC	690	690	
Rated operational current	$I_e$	A	50	100	
Rated conditional short-circuit current	$I_e$	kA	100	100	
Rated frequency	f	Hz	50	50	
Utilization category			AC 22 B	AC 21 B	
Rated impulse withstand voltage	$U_{imp}$	kV	8	8	
Max. permissible heat dissipation of the fuse		W	gG: 5, aM: 3	gG: 9.5, aM: 7	
<b>Mechanical</b>					
Standard front dimension		mm	45	45	
Device height		mm	94	121	
Mounting width		mm	27/per pole	36/per pole	
Weight		g	1P 100 1P+N 222 2P 201 3P 308 3P+N 437	1P 160 1P+N 355 2P 310 3P 480 3P+N 680	
Mounting			Quick attachment for top-hat rail IEC/EN 60715		
Protection type					
Enclosed			IP20		
Terminals			Lift terminals		
Terminal capacity					
Solid		mm <sup>2</sup>	1.5-10	2.5-35	
Temperature range		°C	-25 ... +60	-25 ... +60	
Terminal screw tightening torque					
Tightening torque		Nm	Max. 2	Max. 2.5	
Pollution degree			1	1	
Track resistance			CTI 400	CTI 400	
			Z-D01/SE	Z-D02/SE	
<b>Electrical</b>					
Rated operating voltage		V AC	400	400	
		V DC	220	220	
Utilization category			gG (gL)	gG (gL)	
Rated frequency	f	Hz	45-65	45-65	
Rated insulation voltage	$U_i$	V	2500	2500	
Rated short-circuit switching capacity			50 kA (AC) 8 kA (DC)	50 kA (AC) 8 kA (DC)	
			Z-SLS/B	Z-SLS/B24	Z-SLS/TR-SET
<b>Electrical</b>					
Rated operating voltage		V DC	-	24	-
Rated operating voltage		V AC	60 - 400	24	400
Utilization category			gG (gL)	gG (gL)	-
Test voltage		kV	5	5	5
Rated uninterrupted current	$I_u$	A	-	-	63



			C10-FD/...
<b>Electrical</b>			
Standards			IEC/EN 60947-1 Ed. 4.0, EN 60947-1:1999+A1:2000+A2:2001 IEC/EN 60947-3 Ed. 2.1, EN 60947-3:1999+A1:2001
No. of poles			1, 2
Rated voltage	$U_e$	V DC	1000
Rated operational current	$I_e$	A	20
Rated conditional short-circuit current		kA	10
Utilization category			DC 20 B
Rated insulation voltage	$U_i$	V DC	1000
Overvoltage category			II
Rated impulse withstand voltage	$U_{imp}$	kV	4
Current heat loss per contact without fuse		W	0.9
Max. heat dissipation of fuse		W	3
<b>Mechanical</b>			
Standard front dimension		mm	45
Device height		mm	83.3
Mounting width		mm	17.5/pole
Weight			
1P		g	58
2P		g	70
Mounting			Quick attachment for top-hat rail IEC/EN 60715
Protection type			IP20
Terminals top and bottom			Lift terminals
Terminal cross-section			0.5 - 10 mm <sup>2</sup> AWG 20 - 8
Tightening torque of the terminal screws		Nm	1.5
Ambient temperature range		°C	-25 - +40
Flammability classification			Glow wire 960 °C
Pollution degree			2
Track resistance			CT1 450

			Z-C10/SE 10 x 38	Z-C12/SE 14 x 51	Z-C22/SE 22 x 58
<b>Electrical</b>					
Standards			IEC 60269-1 and IEC 60269-2-1		
Utilization category			gG (gL)	gG (gL)	gG (gL)
Rated voltage	$U_n$	V AC	1 - 25 A/500 32 A/400	2 - 32 A/690 40 - 50 A/500	16 - 40 A/690 50 - 100 A/500
Utilization category			aM	aM	aM
Rated voltage	$U_n$	V AC	1 - 16 A/500 20 - 32 A/400	2 - 25 A/690 32 - 50 A/500	16 - 50 A/690 80 - 100 A/500
Rated frequency	f	Hz	50	50	50
Rated short-circuit breaking capacity		kA	100	100	100

			Z-C10/SE-.../PV 10 x 38
<b>Electrical</b>			
Standards			IEC 60269-1 and IEC 60269-4
Rated voltage	$U_n$	V DC	6 - 20 A/1000 25 A/900
Rated short-circuit breaking capacity		kA	30
$\tau = L/R$		ms	2

WWW.TM2A.PT info@tm2a.pt

WWW.TM2A.PT info@tm2a.pt

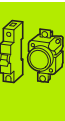

				GST...00-160	GST...1	GST...2	GST...3
<b>General</b>							
Standards				IEC/EN 60947-3			
Climatic proofing				Damp heat, constant, to IEC 60068-2-78 Damp heat, cyclic, to IEC 60068-2-30			
Ambient temperature			°C	-25 ... +55	-25 ... +55	-25 ... +55	-25 ... +55
Installation altitude			m	max. 2000	max. 2000	max. 2000	max. 2000
Mounting position				Vertical, horizontal			
Overvoltage category/pollution degree				III/3	III/3	III/3	III/3
Busbar tag shroud at the front							
Operational status				IP20	IP20	IP20	IP20
Front cover open				IP10	IP10	IP10	IP10
Direction of incoming supply				Any			
Weight			kg	0.72 GSTA 0.93 GST	2.5 GSTA 4.4 GST	3.3 GSTA 5.3 GST	4.6 GSTA 6.6 GST
<b>Contacts</b>							
Rated operating voltage			$U_e$ V AC	500 690	500 690	500 690	500 690
Rated operating voltage			$U_e$ V DC	220 440	220 440	220 440	220 440
Rated operational current			$I_e$ A	160 100	250 200	400 315	630 500
Rated frequency			Hz	40 - 60	40 - 60	40 - 60	40 - 60
Rated conditional short-circuit current AC			$kA_{rms}$	50	50	50	50
Rated conditional short-circuit current, DC			$kA_{rms}$	25	25	25	25
Utilization category AC-22B							
Rated making capacity			A	480 300	750 600	1200 945	1890 1500
Rated breaking capacity			A	480 300	750 600	1200 945	1890 1500
Utilization category DC-21B							
Rated making capacity			A	150	300	475	750
Rated breaking capacity			A	150	300	475	750
Lifespan, electrical Operations				300	200	200	200
Lifespan, mechanical Operations				1700	1400	800	800
Heat dissipation at $I_{th}$ AC, without NH-SE			W	6.9 2.7	12.9 8.3	27 16.7	52 32.8
Heat dissipation at $I_{th}$ DC, without NH-SE			W	4.6 1.8	8.6 5.5	18 11.2	34.7 21.8
Rated insulation voltage			$U_i$ V AC	750	750	750	750
<b>Max. fuse link</b>							
Size				NH00	NH1	NH2	NH3
Max. rated operational current, gL/gG			A	160	250	400	630
Max. admissible heat dissipation, NH-SE			$P_v$ W	12	23	34	48
<b>Terminal capacity</b>							
Box terminal							
Stranded			mm <sup>2</sup>	1.5 - 70	-	-	-
Copper strip			Number of layers x width x thickness	6 x 9 x 0.8	-	-	-
Tightening torque			Nm	2.6	-	-	-
Flange connection							
Bolt diameter				-	M10	M10	M10
Cable lug			mm	-	1 x 25 - 150	1 x 25 - 240	1 x 25 - 300
Flat rail			mm	-	30 x 10	30 x 10	40 x 10
Tightening torque			Nm	-	30 - 35	30 - 35	30 - 35
Box terminal							
Stranded copper			mm <sup>2</sup>	1.5 - 70	25 - 150	25 - 240	25 - 300
Copper strip			Number of layers x width x thickness	-	6 x 16 x 0.8	10 x 16 x 0.8	11 x 21 x 1
Tightening torque			Nm	-	9.5	23	23
Clamp-type cable terminal							
Stranded aluminum/copper			mm <sup>2</sup>	-	70 - 150	120 - 240	120 - 300
Tightening torque			Nm	-	4.5	11	11
Double clamp-type terminal							
Stranded aluminum/copper			mm <sup>2</sup>	-	2 x (70 - 95)	2 x (120 - 150)	2 x (120 - 240)
Tightening torque			Nm	-	4.5	11	11



			GS00-160	GSU1	GSU2	GSU3
<b>General</b>						
Standards			IEC/EN 60 269-2-1; VDE0636-201			
Climatic proofing			Damp heat, constant, to IEC 60068-2-78 Damp heat, cyclic, to IEC 60068-2-30			
Ambient temperature		°C	-25 ... +55	-25 ... +55	-25 ... +55	-25 ... +55
Installation altitude		m	max. 2000	max. 2000	max. 2000	max. 2000
Mounting position			Vertical, horizontal	Vertical, horizontal	Vertical, horizontal	Vertical, horizontal
Overvoltage category/degree of pollution			III/3	III/3	III/3	III/3
Busbar tag shroud at the front						
Operational status			IP00	IP00	IP00	IP00
Direction of incoming supply			Any	Any	Any	Any
Weight		kg	0.4	1.7	2.1	2.7
<b>Contacts</b>						
Rated operating voltage	$U_e$	V AC	690	690	690	690
Rated operating voltage	$U_e$	V DC	440	440	440	440
Rated operational current	$I_e$	A	160	250	400	630
Rated frequency		Hz	40 - 60	40 - 60	40 - 60	40 - 60
Heat dissipation at $I_{th}$ AC, without NH-SE		W	6.9	12.9	27	52
Heat dissipation at $I_{th}$ DC, without NH-SE		W	4.6	8.6	18	34.7
Rated insulation voltage	$U_i$	V AC	750	750	750	750
<b>Max. fuse link</b>						
Size			NH00	NH1	NH2	NH3
Max. rated operational current, gL/gG		A	160	250	400	630
Max. admissible heat dissipation NH-SE	$P_v$	W	12	23	34	48
<b>Terminal capacity</b>						
Box terminal						
Stranded		mm <sup>2</sup>	-	-	-	-
Copper strip	Number of layers x width x thickness	mm	-	-	-	-
Tightening torque		Nm	-	-	-	-
Flange connection						
Bolt diameter			-	M10	M10	M10
Cable lug		mm	-	1 x 25 - 150	1 x 25 - 240	1 x 25 - 300
Flat rail		mm	-	30 x 10	30 x 10	40 x 10
Tightening torque		Nm	-	30 - 35	30 - 35	30 - 35
Box terminal						
Stranded copper		mm <sup>2</sup>	1.5 - 70	25 - 150	25 - 240	25 - 300
Copper strip	Number of layers x width x thickness	mm	6 x 9 x 0.8	6 x 16 x 0.8	10 x 16 x 0.8	11 x 21 x 1
Tightening torque		Nm	2.6	9.5	23	23
Clamp-type cable terminal						
Stranded aluminum/copper		mm <sup>2</sup>	-	70 - 150	120 - 240	120 - 300
Tightening torque		Nm	-	4.5	11	11
Double clamp-type terminal						
Stranded aluminum/copper		mm <sup>2</sup>	-	2 x 70 - 95	2 x 120 - 150	2 x 120 - 240
Tightening torque		Nm	-	4.5	11	11





Dimensions

Miniature circuit-breakers (MCB)

FAZ...

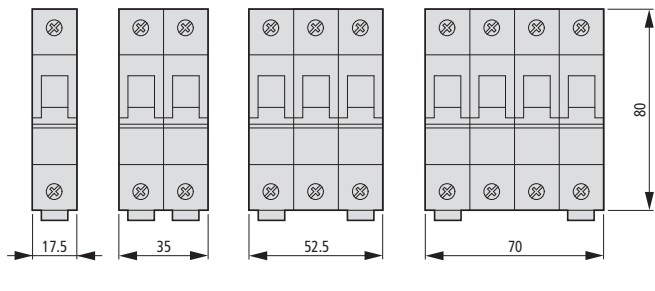

FAZ-PN...

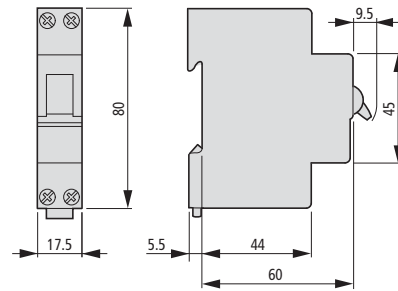

FAZT

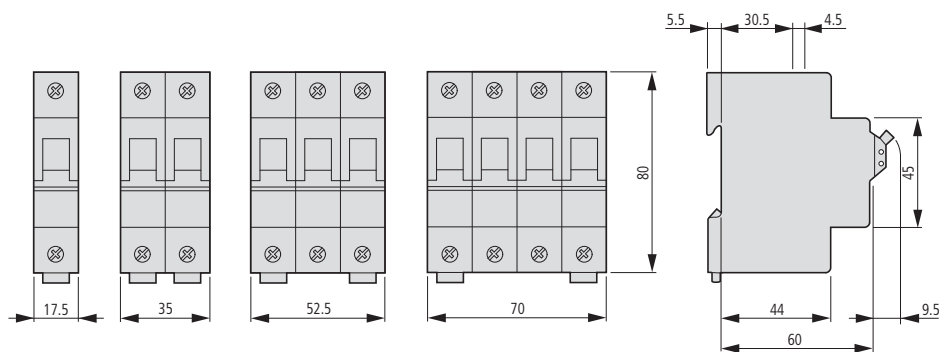

AZ...

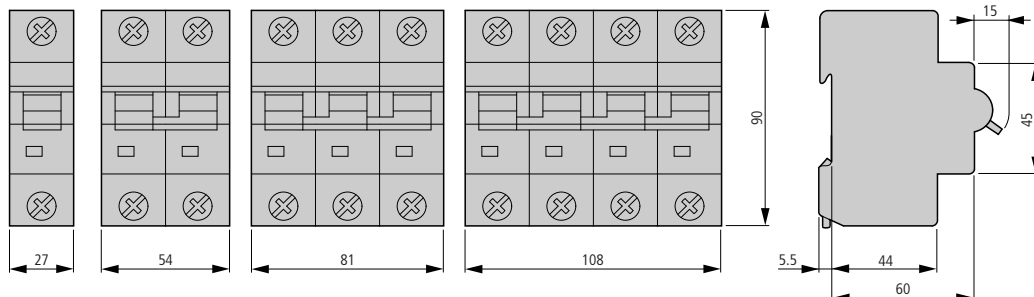

Residual-current protective modules

FIM...

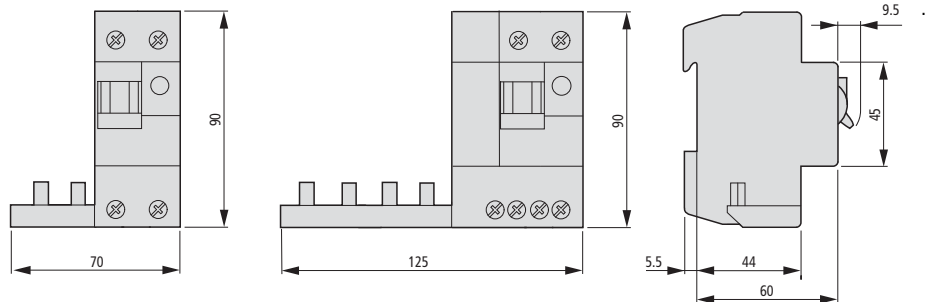

Combination switches

PKNM...

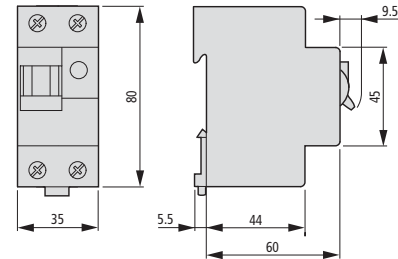

Residual-current protective modules

AZFIM...

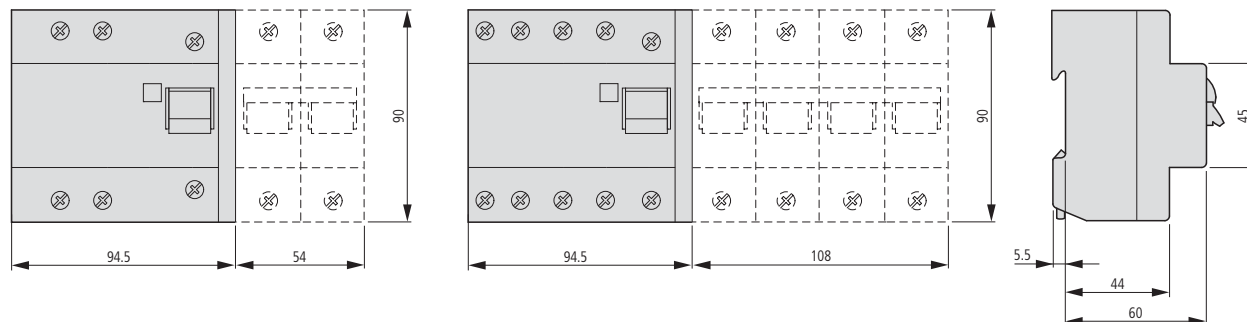

WWW.TM2A.PT info@tm2a.pt

WWW.TM2A.PT info@tm2a.pt



**Combination FI/LS switches**

mRB6..., mRB4...

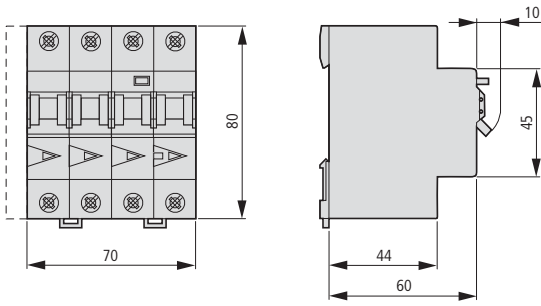

**Residual-current devices**

FI...

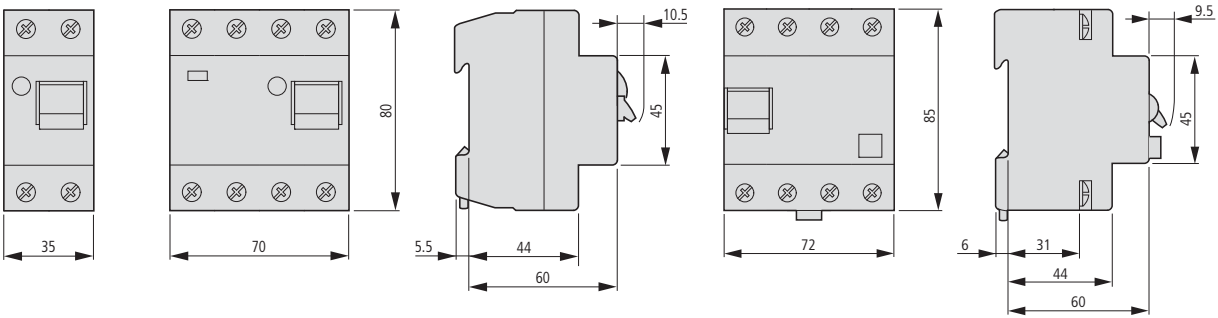

**Residual-current devices**

dRCM...

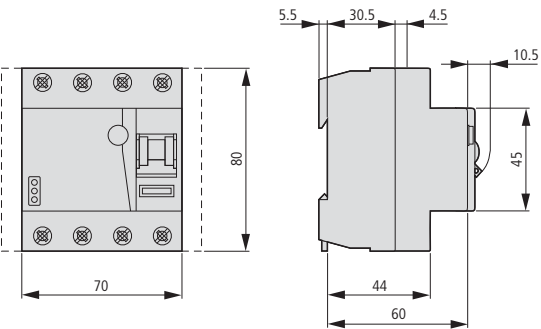

**Remote monitoring unit**

Z-CC/2CO

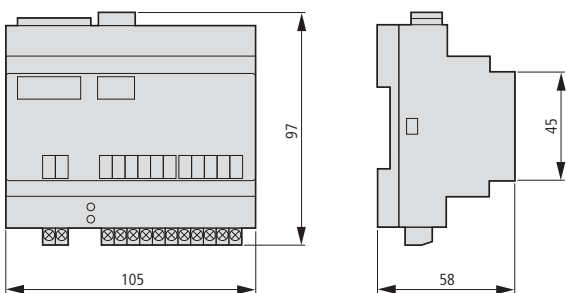

**Temperature sensor**

Z-CC/2CO-SE

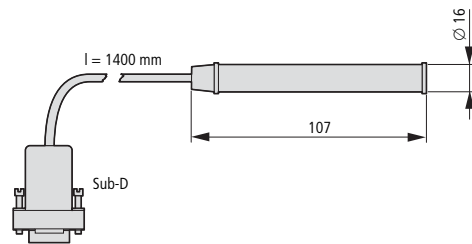

**Leakage current meter**

PDIM

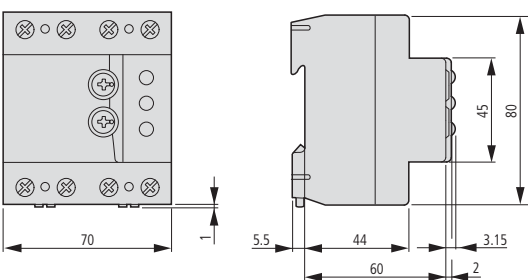

WWW.TM2A.PT info@tm2a.pt

WWW.TM2A.PT info@tm2a.pt

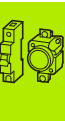

**Auxiliary contacts**

FAZ-XHIN11

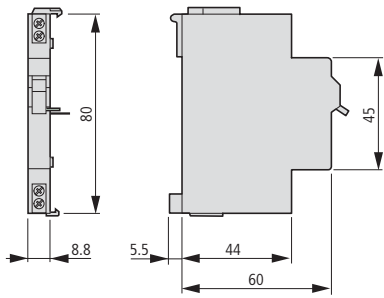

FAZ-XAM002

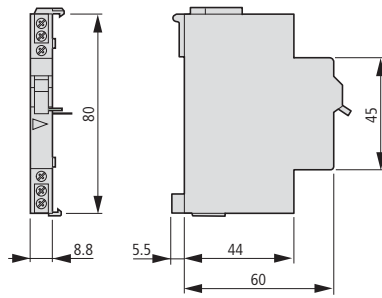

AZ-XHI11

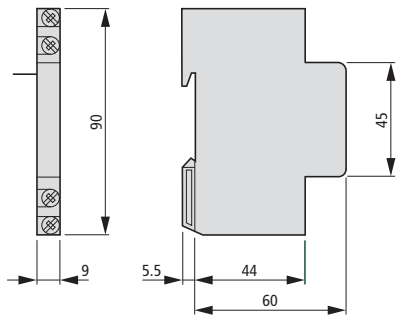

FIP-XHI11

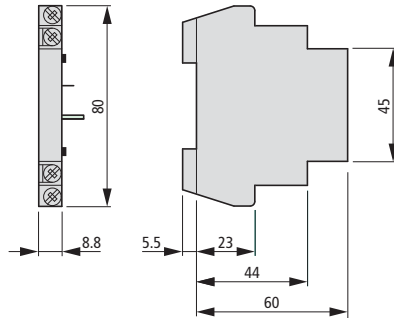

FIPA-XAM011

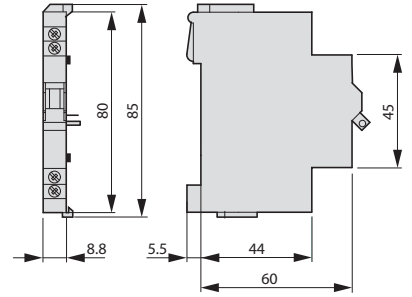

**Shunt release**

FAZ-XAA-C...

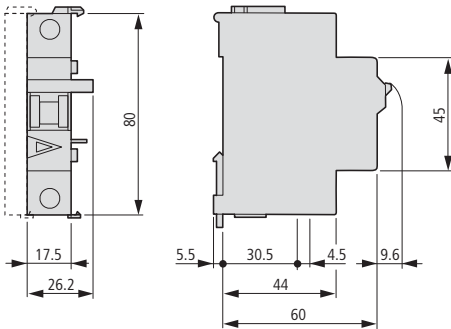

**Shunt release**

AZ-XAA...

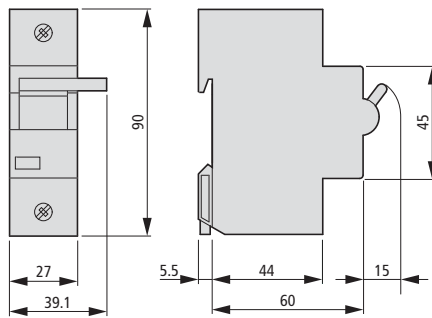

**Under voltage release**

FAZ-XUA...

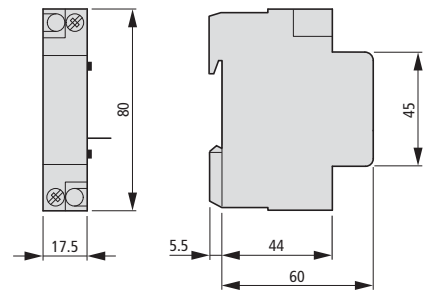

**Remote switching modules**

FAZ/FIP...

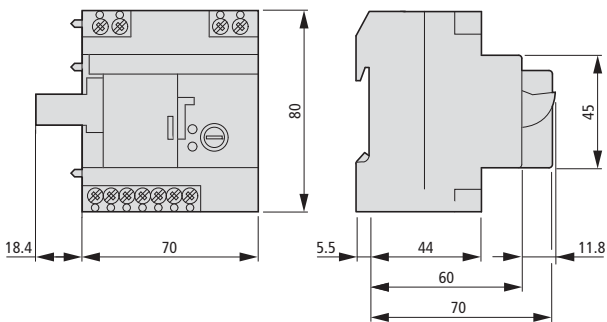

Z-FW-LP  
Z-FW-LPD

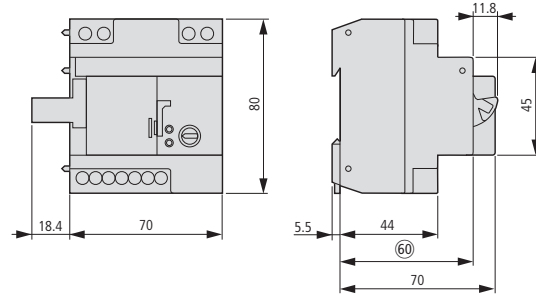

Z-FW-M0

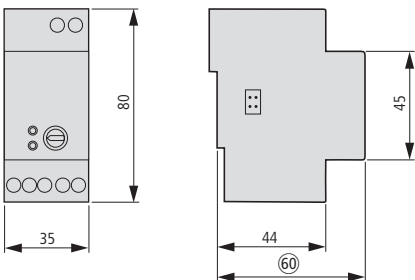

WWW.TM2A.PT info@tm2a.pt

WWW.TM2A.PT info@tm2a.pt

**Power meter**

KWZ-3PH...

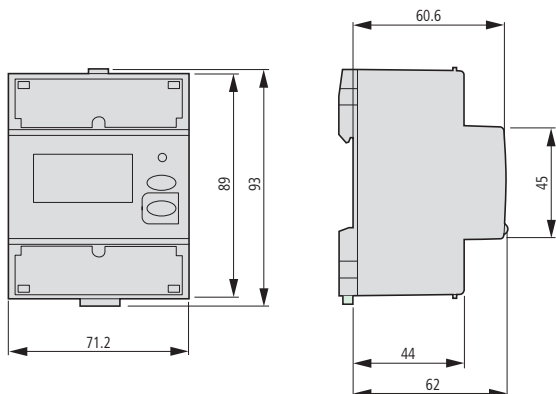

**Euro-Vario busbars**

EVG-10(16)/...

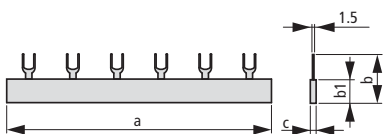

Part no.	a	b	b1	c
EVG-(16)/1PHAS/2MODUL	33	25.9	14	3.4
EVG-(16)/1PHAS/6MODUL	105	25.9	14	3.4
EVG-(16)/1PHAS/12MODUL	210	25.9	14	3.4
EVG-(16)/2PHAS/4MODUL	75.5	30.9	19	7.3
EVG-(16)/2PHAS/6MODUL	105	30.9	19	7.3
EVG-(16)/2PHAS/12MODUL	209.5	30.9	19	7.3
EVG-(16)/3PHAS/6MODUL	102.5	30.9	19	10.3
EVG-(16)/3PHAS/9MODUL	156	30.9	19	10.3
EVG-(16)/3PHAS/12MODUL	209.5	30.9	19	10.3
EVG-(16)/3PHAS/16MODUL	285	30.9	19	10.3
EVG-(16)/3PHAS/20MODUL	353	30.9	19	10.3
EVG-(16)/4PHAS/8MODUL	138	30.9	19	13.3
EVG-(16)/4PHAS/12MODUL	209.5	30.9	19	13.3
EVG-(16)/3PHAS/N/5MODUL/LS	156	30.9	19	10.3
EVG-(16)/3PHAS/N/8MODUL/LS	209.5	30.9	19	10.3
EVG-(16)/1PHAS/2MODUL/HI	60	25.9	14	3.4
EVG-(16)/1PHAS/6MODUL/HI	156.5	25.9	14	3.4
EVG-(16)/1PHAS/9MODUL/HI	237	25.9	14	3.4
EVG-(16)/2PHAS/4MODUL/HI	75.5	30.9	19	7.3
EVG-(16)/2PHAS/6MODUL/HI	120	30.9	19	7.3
EVG-(16)/2PHAS/10MODUL/HI	209.5	30.9	19	7.3
EVG-(16)/3PHAS/6MODUL/HI	115	30.9	19	10.3
EVG-(16)/3PHAS/12MODUL/HI	237	30.9	19	10.3
EVG-(16)/3x 1PHAS/6MODUL/HI	152	30.9	19	10.3
EVG-(16)/3x 1PHAS/8MODUL/HI	209.5	30.9	19	10.3
EVG-(16)/3x 1PHAS/9MODUL/HI	229	30.9	19	10.3

**Connecting bracket**

ZV-...-80A-...

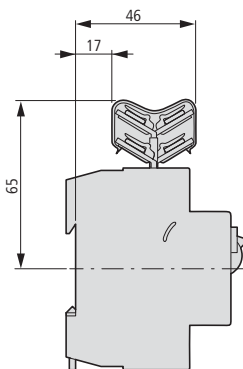

**Miniature circuit-breakers (MCB)**

FAZ-...-NA, FAZ-...-RT

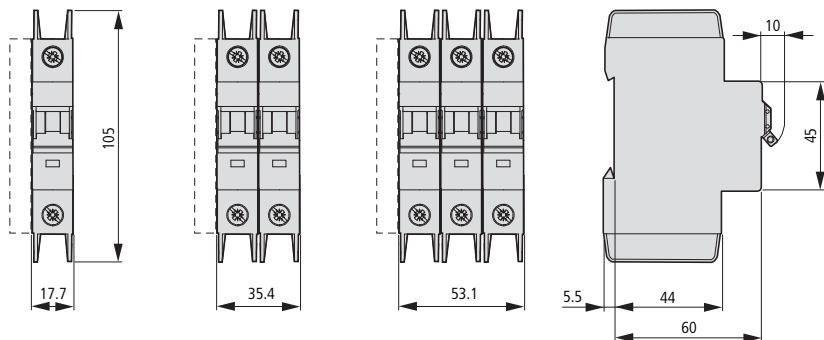

WWW.TM2A.PT info@tm2a.pt

WWW.TM2A.PT info@tm2a.pt



Tripping signal contact

Z-NHK

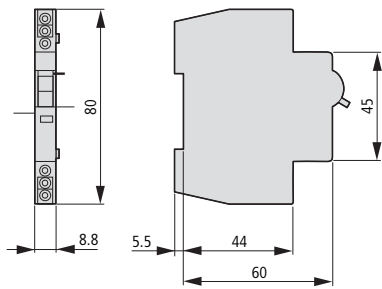

Auxiliary contacts

Z-IHK-NA

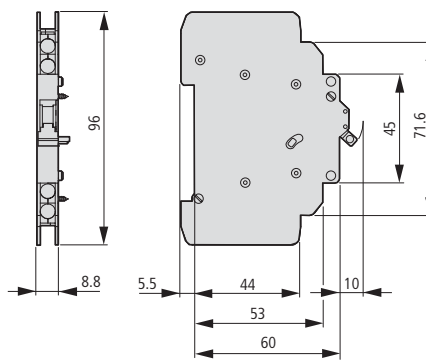

Shunt release

FAZ-XAA-NA...

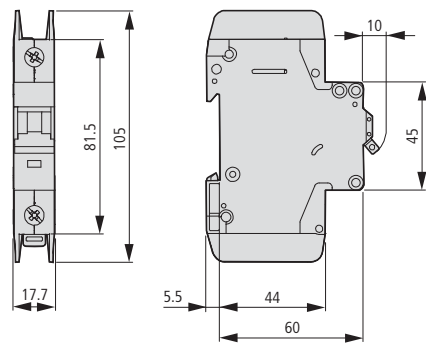

Fuse bases

D01-S0/...

D02-S0/...

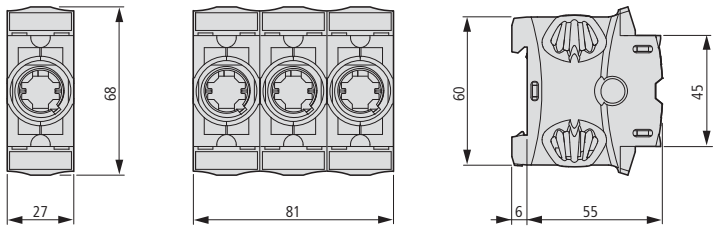

Fuse switch-disconnectors

Z-SLS/NEOZ/...

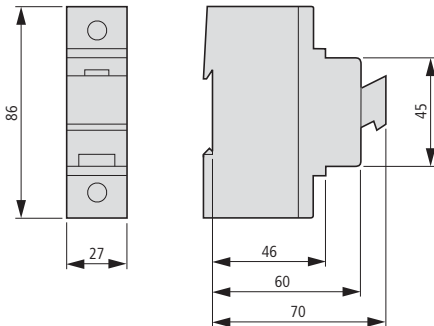

With fuse monitoring, empty

Z-SLK/NEOZ/...

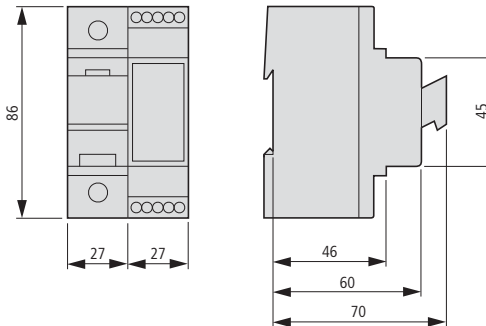

info@tm2a.pt

WWW.TM2A.PT

info@tm2a.pt

WWW.TM2A.PT



Fuse switch-disconnectors, empty

VLC14...

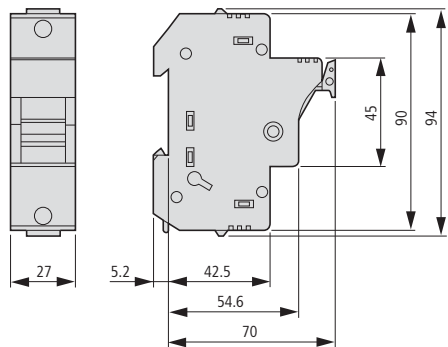

VLC22...

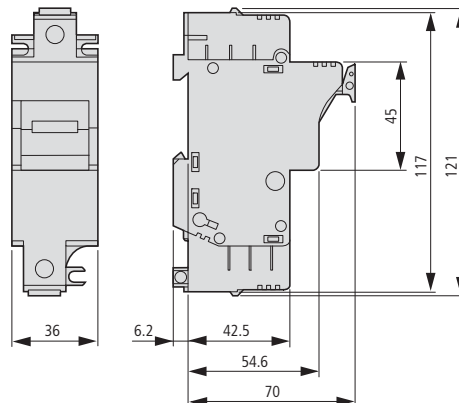

Fuse switch-disconnectors

C10-FD/20/...

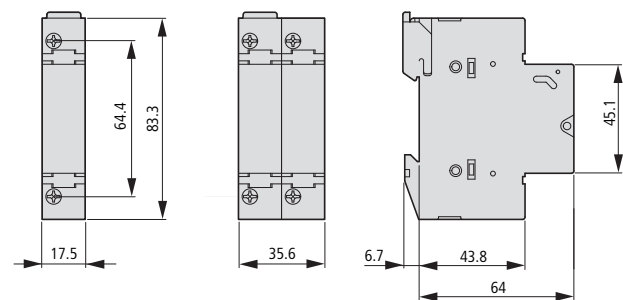

LV h.b.c. fuse bases

GSU1

GSU2

GSU3

GS00-160

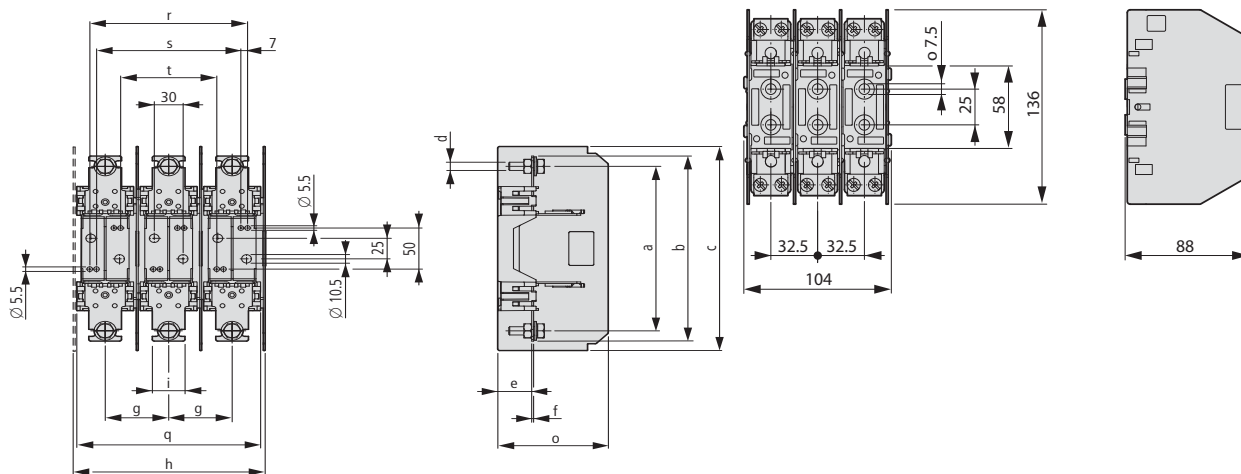

Part no.	a	b	c	d	e	f	g	h	l	o	q	r	s	t
GSU1	175	200	248	M10	35	2	66	200	34	107	191	164	150	100
GSU2	200	225	248	M10	35	2	66	200	34	115	191	164	150	100
GSU3	210	250	273	M10	35	3	84	254	40	132.5	245	200	186	136

info@tm2a.pt

WWW.TM2A.PT

info@tm2a.pt

WWW.TM2A.PT



LV h.b.c. fuse switch-disconnectors

1 pole

GSTA00-160-1P

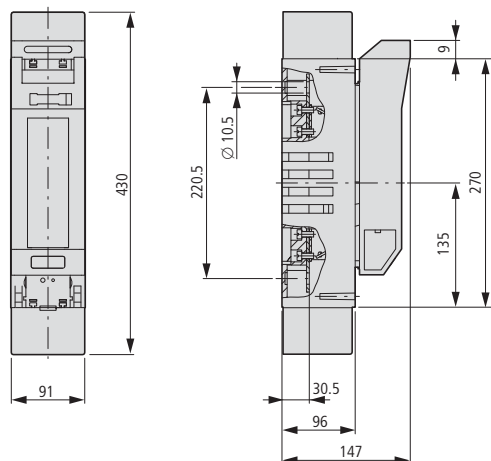

3 pole

GSTA00-160

GSTA1

GSTA2

GSTA3

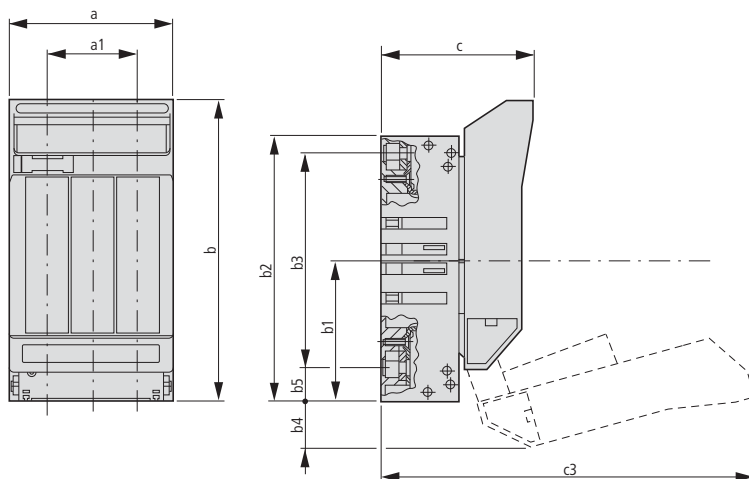

Part no.	a	a1	b	b1	b2	b3	b4	b5	c	c3	d	e	f
GSTA00-160-1P	49	-	169	79	149	120	-	-	86.5	-	7	-	-
GSTA00-160	106	66	169	79	149	120	25	26	86.5	197	7	50	-
GSTA1	182	116	250	115	230	184	30	23	111	294	5.5	150	-
GSTA2	208	132	275	128	256	217	30	19.5	125	330.5	5.5	175	25
GSTA3	254	164	283	135	270	238	30	16	142	348	5.5	200	50

LV h.b.c. fuse switch-disconnectors, drilling dimensions

GSTA00-160

GSTA2

GSTA1

GSTA3

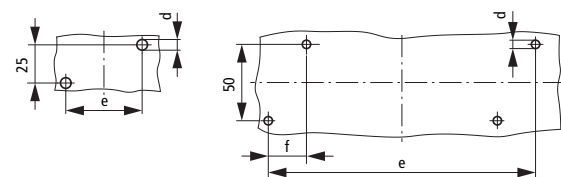

Part no.	a	a1	b	b1	b2	b3	b4	b5	c	c3	d	e	f
GSTA00-160-1P	49	-	169	79	149	120	25	-	86.5	197	7	-	-
GSTA00-160	106	66	169	79	149	120	25	26	86.5	197	7	50	-
GSTA1	182	116	250	115	230	184	30	23	111	294	5.5	150	-
GSTA2	208	132	275	128	256	217	30	19.5	125	330.5	5.5	175	25
GSTA3	254	164	283	135	270	238	30	16	142	348	5.5	200	50

LV h.b.c. fuse links

Z-NH...

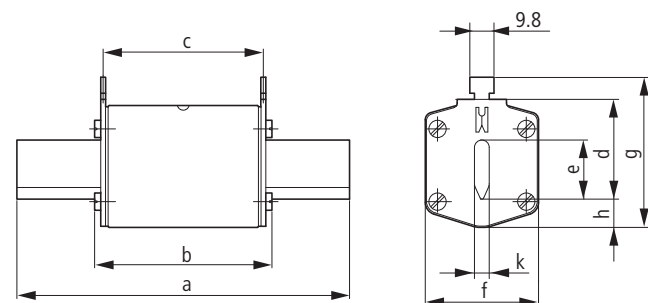

Part no.		a	b	c	d	e	f	g	h	k
Z-NH-00/	Up to 100 A	79	53	47	35	15	21	52	7.5	6
	125-160 A	79	53	47	35	15	28	56	12	6
Z-NH-1/	Up to 160 A	135	68	65	40	15	28	61	12	6
	200-250 A	135	72	65	40	20	46	65	14	6
Z-NH-2/	to 250 A	150	72	65	48	20	46	73	14	6
	315-400 A	150	72	65	48	26	54	73	14	6
Z-NH-3/	to 400 A	150	72	65	60	26	54	84	14	6
	500-630 A	150	72	65	60	33	65	84	14	6

WWW.TM2A.PT info@tm2a.pt

WWW.TM2A.PT info@tm2a.pt

