

VACON® 10
AC DRIVES

COMPLETE USER MANUAL

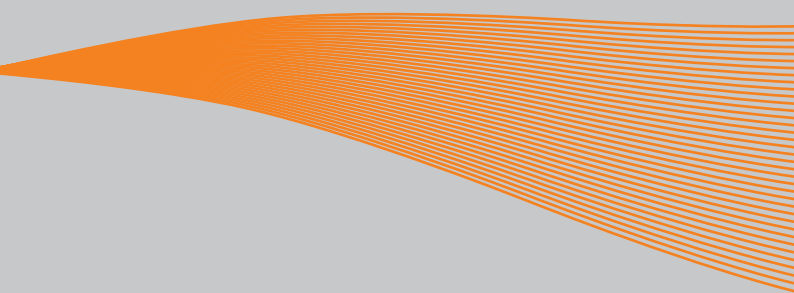

VACON®
DRIVEN BY DRIVES

1. Safety	1
1.1 Warnings	1
1.2 Safety instructions	3
1.3 Earthing and earth fault protection	3
1.4 Before running the motor	4
2. Receipt of delivery	5
2.1 Type designation code	5
2.2 Storage	6
2.3 Maintenance	6
2.4 Warranty	6
2.5 Manufacturer's declaration of conformity	7
3. Installation	9
3.1 Mechanical installation	9
3.1.1 Vacon 10 dimensions	10
3.1.2 Cooling	12
3.1.3 Power losses	13
3.1.4 EMC levels	18
3.1.5 Changing the EMC protection class from C2 to C4	19
3.2 Cabling and connections	20
3.2.1 Power cabling	20
3.2.2 Control cabling	21
3.2.3 Screw of cables	23
3.2.4 Cable and fuse specifications	25
3.2.5 General cabling rules	28
3.2.6 Stripping lengths of motor and mains cables	29
3.2.7 Cable installation and the UL standards	29
3.2.8 Cable and motor insulation checks	29
4. Commissioning	31
4.1 Commissioning steps of Vacon 10	31
5. Fault tracing	33
6. Vacon 10 Application Interface	37
6.1 Introduction	37
6.2 Control I/O	39
7. Control panel	41
7.1 General	41
7.2 Display	41
7.3 Keypad	42
7.4 Navigation on the Vacon 10 control panel	44
7.4.1 Main menu	44
7.4.2 Reference menu	45
7.4.3 Monitoring menu	46
7.4.4 Parameter menu	48
7.4.5 System menu	50

8. STANDARD application parameters	53
8.1 Quick setup parameters	
Virtual menu, shows when par. 17.2 = 1)	54
8.2 Motor settings (Control panel: Menu PAR -> P1)	56
8.3 Start / stop setup (Control panel: Menu PAR -> P2)	58
8.4 Frequency references (Control panel: Menu PAR -> P3)	58
8.5 Ramps and brakes setup (Control panel: Menu PAR -> P4)	59
8.6 Digital inputs (Control panel: Menu PAR -> P5)	60
8.7 Analogue inputs (Control panel: Menu PAR -> P6)	60
8.8 Digital outputs (Control panel: Menu PAR -> P8)	61
8.9 Analogue outputs (Control panel: Menu PAR -> P9)	61
8.10 Protections (Control panel: Menu PAR -> P13)	62
8.11 Fault autoreset parameters (Control panel: Menu PAR -> P14)	62
8.12 PI control parameters (Control panel: Menu PAR -> P15)	63
8.13 Application Setting (Control panel: Menu PAR -> P17)	63
8.14 System parameters	64
9. Parameter descriptions	67
9.1 Motor settings (Control panel: Menu PAR -> P1)	67
9.2 Start / stop setup (Control panel: Menu PAR -> P2)	72
9.3 Frequency references (Control panel: Menu PAR -> P3)	79
9.4 Ramps & brakes setup (Control panel: Menu PAR -> P4)	80
9.5 Digital inputs (Control panel: Menu PAR -> P5)	84
9.6 Analogue inputs (Control panel: Menu PAR -> P6)	85
9.7 Digital outputs (Control panel: Menu PAR -> P8)	86
9.8 Analogue outputs (Control panel: Menu PAR -> P9)	87
9.9 Protections (Control panel: Menu Par->P13)	88
9.10 Automatic reset (Control panel: Menu PAR -> P14)	92
9.11 PI control parameters (Control panel: Menu PAR -> P15)	93
9.12 Application setting (Control panel: Menu PAR->P17)	94
9.13 Modbus RTU	96
9.13.1 Termination resistor	96
9.13.2 Modbus address area	96
9.13.3 Modbus process data	97
10. Technical data	99
10.1 Vacon 10 technical data	99
10.2 Power ratings	101
10.2.1 Vacon 10 – Mains voltage 208-240 V	101
10.2.2 Vacon 10 – Mains voltage 115 V	102
10.2.3 Vacon 10 – Mains voltage 380-480 V	102
10.2.4 Vacon 10 – Mains voltage 600 V	103
10.3 Brake resistors	103

1. SAFETY



ONLY A COMPETENT ELECTRICIAN IS ALLOWED TO CARRY OUT THE ELECTRICAL INSTALLATION!

This manual contains clearly marked cautions and warnings which are intended for your personal safety and to avoid any unintentional damage to the product or connected appliances.

Please read the information included in cautions and warnings carefully:

	<p>=Dangerous voltage Risk of death or severe injury</p>
	<p>=General warning Risk of damage to the product or connected appliances</p>

1.1 Warnings



The components of the power unit of the frequency converter are live when Vacon 10 is connected to mains. Coming into contact with this voltage is extremely dangerous and may cause death or severe injury. The control unit is isolated from the mains potential.



The motor terminals U, V, W (T1, T2, T3) and the possible brake resistor terminals - / + are live when Vacon 10 is connected to mains, even if the motor is not running.



The control I / O-terminals are isolated from the mains potential. However, the relay output terminals may have a dangerous control voltage present even when Vacon 10 is disconnected from mains.



The earth leakage current of Vacon 10 frequency converters exceeds 3.5 mA AC. According to standard EN61800-5-1, a reinforced protective ground connection must be ensured.



If the frequency converter is used as a part of a machine, the machine manufacturer is responsible for providing the machine with a main switch [EN 60204-1].



If Vacon 10 is disconnected from mains while running the motor, it remains live if the motor is energized by the process. In this case the motor functions as a generator feeding energy to the frequency converter.



After disconnecting the frequency converter from the mains, wait until the fan stops and the indicators on the display go out. Wait 5 more minutes before doing any work on Vacon 10 connections.



The motor can start automatically after a fault situation, if the autoreset function has been activated.

1.2 Safety instructions



The Vacon 10 frequency converter has been designed for fixed installations only.



Do not perform any measurements when the frequency converter is connected to the mains.



Do not perform any voltage withstand tests on any part of Vacon 10. The product safety is fully tested at factory.



Prior to measurements on the motor or the motor cable, disconnect the motor cable from the frequency converter.



Do not open the cover of Vacon 10. Static voltage discharge from your fingers may damage the components. Opening the cover may also damage the device. If the cover of Vacon 10 is opened, warranty becomes void.

1.3 Earthing and earth fault protection

The Vacon 10 frequency converter **must always** be earthed with an earthing conductor connected to the earthing terminal. See figure below:

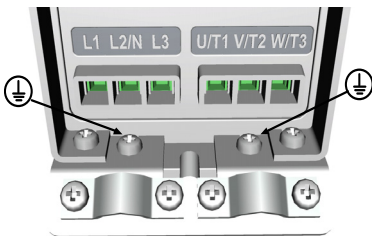

MI1 - MI3

- The earth fault protection inside the frequency converter protects only the converter itself against earth faults.
- If fault current protective switches are used they must be tested with the drive with earth fault currents that are possible to arise in fault situations.

1.4 Before running the motor

Checklist:



Before starting the motor, check that the motor is mounted properly and ensure that the machine connected to the motor allows the motor to be started.



Set the maximum motor speed (frequency) according to the motor and the machine connected to it.



Before reversing the motor shaft rotation direction make sure that this can be done safely.



Make sure that no power correction capacitors are connected to the motor cable.

NOTE! You can download the English and French product manuals with applicable safety, warning and caution information from www.vacon.com/downloads.

REMARQUE Vous pouvez télécharger les versions anglaise et française des manuels produit contenant l'ensemble des informations de sécurité, avertissements et mises en garde applicables sur le site www.vacon.com/downloads.

2. RECEIPT OF DELIVERY

After unpacking the product, check that no signs of transport damages are to be found on the product and that the delivery is complete (compare the type designation of the product to the code below).

Should the drive have been damaged during the shipping, please contact primarily the cargo insurance company or the carrier.

If the delivery does not correspond to your order, contact the supplier immediately.

2.1 Type designation code

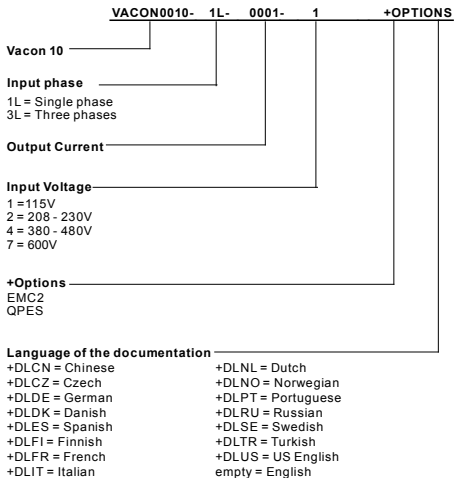

Figure 2.1: Vacon 10 type designation code

2.2 Storage

If the frequency converter is to be kept in store before use make sure that the ambient conditions are acceptable:

Storing temperature -40...+70°C

Relative humidity < 95%, no condensation

2.3 Maintenance

In normal operating conditions, Vacon 10 frequency converters are maintenance-free.

2.4 Warranty

Only manufacturing defects are covered by the warranty. The manufacturer assumes no responsibility for damages caused during or resulting from transport, receipt of the delivery, installation, commissioning or use.

The manufacturer shall in no event and under no circumstances be held responsible for damages and failures resulting from misuse, wrong installation, unacceptable ambient temperature, dust, corrosive substances or operation outside the rated specifications. Neither can the manufacturer be held responsible for consequential damages.

The Manufacturer's time of warranty is 18 months from the delivery or 12 months from the commissioning whichever expires first (Vacon Warranty Terms).

The local distributor may grant a warranty time different from the above. This warranty time shall be specified in the distributor's sales and warranty terms. Vacon assumes no responsibility for any other warranties than that granted by Vacon itself.

In all matters concerning the warranty, please contact first your distributor.

2.5 Manufacturer's declaration of conformity

**EC DECLARATION OF CONFORMITY**

We

Manufacturer's name: Vacon Oyj
Manufacturer's address: P.O.Box 25
Runsorintie 7
FIN-65381 Vaasa
Finland

hereby declare that the product

Product name: Vacon 10 Frequency Converter
Model designation: Vacon 10 1L 0001 2...to 0009 2
Vacon 10 3L 0001 2...to 0011 2
Vacon 10 3L 0001 4...to 0012 4

has been designed and manufactured in accordance with the following standards:

Safety: EN 60204 -1:2009 (as relevant),
EN 61800-5-1:2007
EMC: EN 61800-3:2004+A1:2012

and conforms to the relevant safety provisions of the Low Voltage Directive 2006/95/EC and EMC Directive 2004/108/EC.

It is ensured through internal measures and quality control that the product conforms at all times to the requirements of the current Directive and the relevant standards.

In Vaasa, 16th of April, 2014

Vesa Laisi
President

The year the CE marking was affixed: 2011

3 INSTALLATION

3.1 Mechanical installation

There are two possible ways to mount Vacon 10 in the wall. For MI1-MI3, either screw or DIN-rail mounting. The mounting dimensions are given on the back of the drive and on the following page.

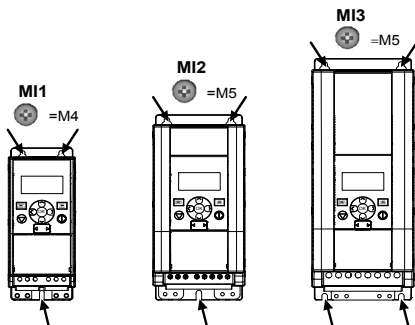

Figure 3.1: Screw mounting, MI1 - MI3

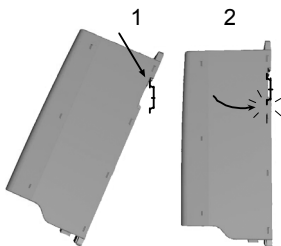

Figure 3.2: DIN-rail mounting, MI1 - MI3

3.1.1 Vacon 10 dimensions

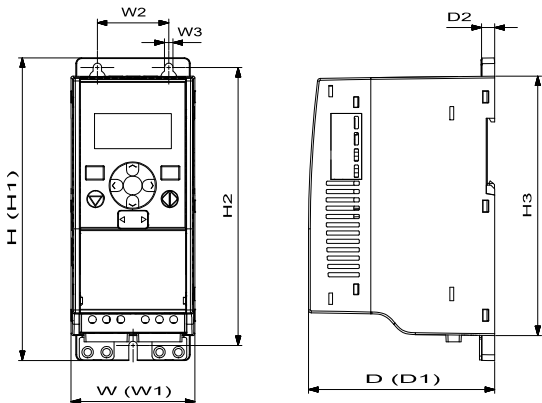

Figure 3.3: Vacon 10 dimensions, MI1 - MI3

Frame	H1	H2	H3	W1	W2	W3	D1	D2
MI1	160.1	147	137.3	65.5	37.8	4.5	98.5	7
MI2	195	183	170	90	62.5	5.5	101.5	7
MI3	254.3	244	229.3	100	75	5.5	108.5	7

Table 3.1: Vacon 10 dimensions in millimetres

Frame	Dimensions(mm)		Weight*	
	W	H	D	(kg.)
MI1	66	160	98	0.5
MI2	90	195	102	0.7
MI3	100	254.3	109	1
				*without shipping package

Table 3.2: Vacon 10 frame dimensions (mm) and weights (kg)

Frame	Dimensions(Inches)		Weight*	
	W	H	D	(lbs.)
MI1	2.6	6.2	3.9	1.2
MI2	3.5	9.9	4	1.5
MI3	3.9	10.3	4.3	2.2
				*without shipping package

Table 3.3: Vacon 10 frame dimensions (Inch) and weights (Ibs)

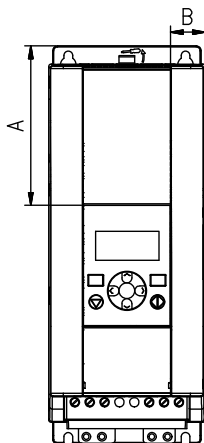

Figure 3.4: Vacon10 dimensions, MI2 - 3 Display Location

Dimensions(mm)	Frame	
	MI2	MI3
A	17	22.3
B	44	102

Table 3.4: Vacon 10 frame dimensions (mm)

3.1.2 Cooling

Enough free space shall be left above and below the frequency converter to ensure sufficient air circulation and cooling. You will find the required dimensions for free space in the table below.

If several units are mounted above each other the required free space equals C + D (see Installation space). Moreover, the outlet air used for cooling by the lower unit must be directed away from the air intake of the upper unit.

The amount of cooling air required is indicated below. Also make sure that the temperature of the cooling air does not exceed the maximum ambient temperature of the converter.

Min clearance (mm)				
Frame	A*	B*	C	D
MI1	20	20	100	50
MI2	20	20	100	50
MI3	20	20	100	50

Table 3.5: Min. clearances around AC drive

*. Min clearance A and B for drives for MI1 - MI3 can be 0 mm if the ambient temperature is below 40 degrees.

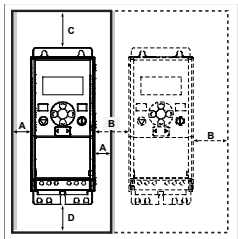

Figure 3.5: Installation space

A = clearance around the freq. converter (see also B)

B = distance from one frequency converter to another or distance to cabinet wall

C = free space above the frequency converter

D = free space underneath the frequency converter

NOTE! See the mounting dimensions on the back of the drive.

Leave **free space** for cooling above (**100 mm**), below (**50 mm**), and on the sides (**20 mm**) of Vacon 10! For MI1 - MI3, side-to-side installation allowed only if the ambient temperature is below 40 °C.

Frame	Cooling air required (m ³ /h)
MI1	10
MI2	10
MI3	30

Table 3.6: Required cooling air

3.1.3 Power losses

If the operator wants to raise the switching frequency of the drive for some reason (typically e.g. in order to reduce the motor noise), this inevitably affects the power losses and cooling requirements, for different motor shaft power, operator can select the switching frequency according to the graphs below.

MI1 - MI3 3P 400 V POWER LOSS

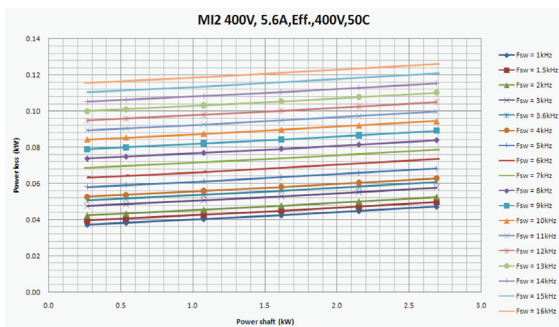
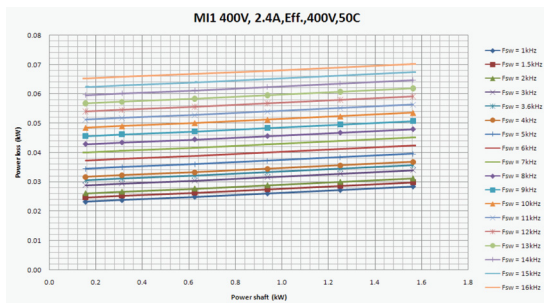

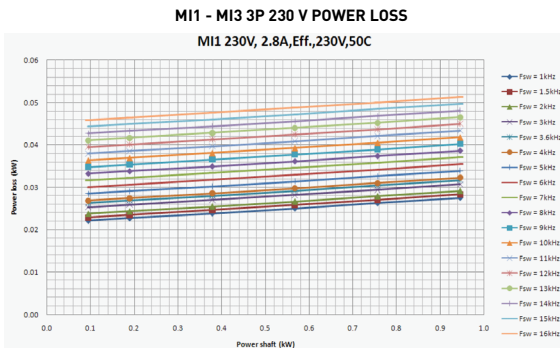
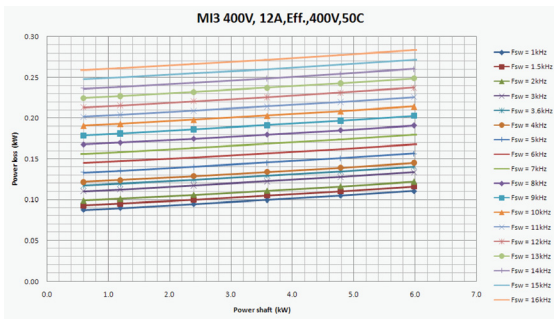

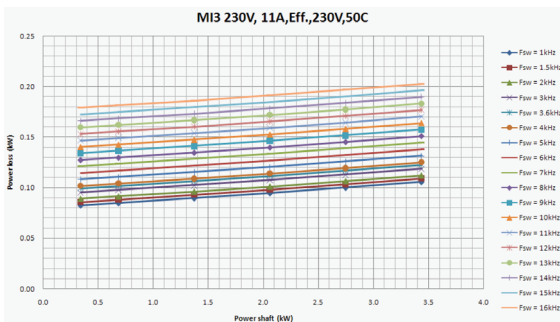
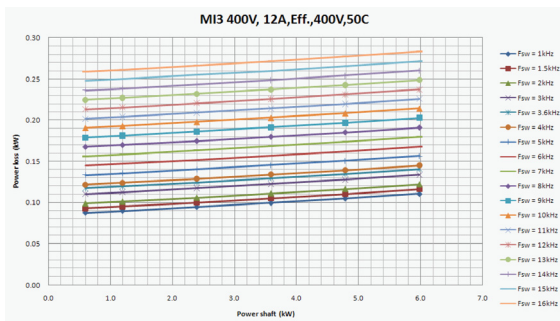

MI1 - MI3 1P 230 V POWER LOSS

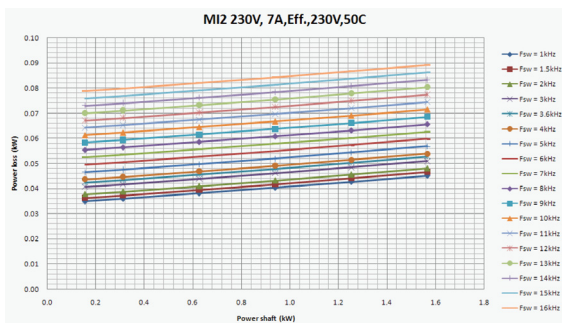
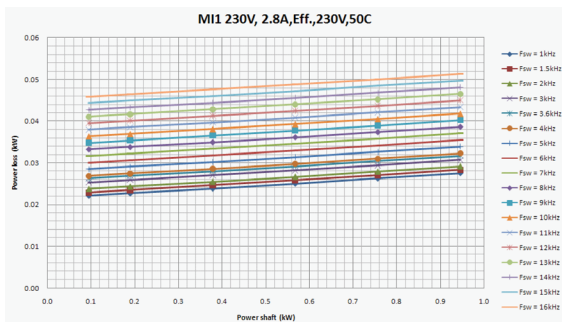

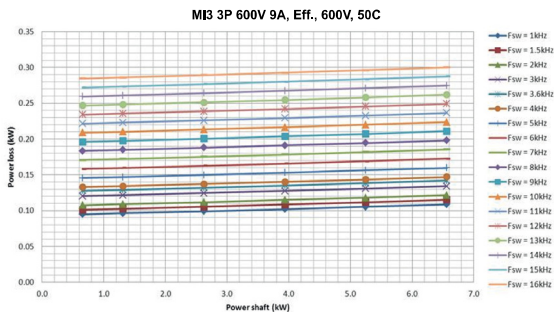
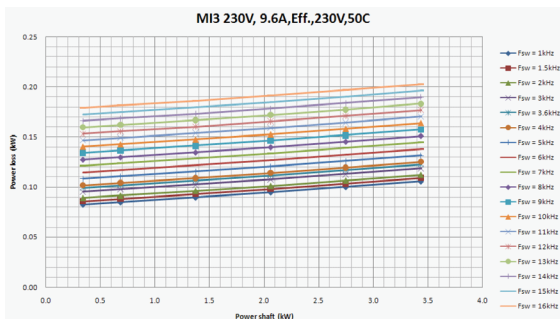

3.1.4 EMC levels

EN61800-3 defines the division of frequency converters into four classes according to the level of electromagnetic disturbances emitted, the requirements of a power system network and the installation environment (see below). The EMC class of each product is defined in the type designation code.

Category C1: Frequency converters of this class comply with the requirements of category C1 of the product standard EN 61800-3 (2004). Category C1 ensures the best EMC characteristics and it includes converters the rated voltage of which is less than 1000 V and which are intended for use in the 1st environment.

NOTE: The requirements of class C are fulfilled only as far as the conducted emissions are concerned.

Category C2: Frequency converters of this class comply with the requirements of category C2 of the product standard EN 61800-3 (2004). Category C2 includes converters in fixed installations and the rated voltage of which is less than 1000 V. The class C2 frequency converters can be used both in the 1st and the 2nd environment.

Category C4: The drives of this class do not provide EMC emission protection. These kinds of drives are mounted in enclosures.

Environments in product standard EN 61800-3 (2004)

First environment: Environment that includes domestic premises. It also includes establishments directly connected without intermediate transformers to a low-voltage power supply network which supplies buildings used for domestic purposes.

NOTE: houses, apartments, commercial premises or offices in a residential building are examples of first environment locations.

Second environment: Environment that includes all establishments other than those directly connected to a low-voltage power supply network which supplies buildings used for domestic purposes.

NOTE: industrial areas, technical areas of any building fed from a dedicated transformer are examples of second environment locations.

3.1.5 Changing the EMC protection class from C2 to C4

The EMC protection class of MI1-3 frequency converters can be changed from class C2 to class C4 (except 115V and 600V drives) by **removing the EMC-capacitor disconnecting screw**, see figure below.

Note! Do not attempt to change the EMC level back to class C2. Even if the procedure above is reversed, the frequency converter will no longer fulfil the EMC requirements of class C2!

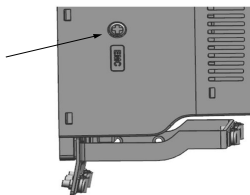

Figure 3.6: EMC protection class, MI1 - MI3

3.2 Cabling and connections

3.2.1 Power cabling

Note! Tightening torque for power cables is 0.5 - 0.6 Nm

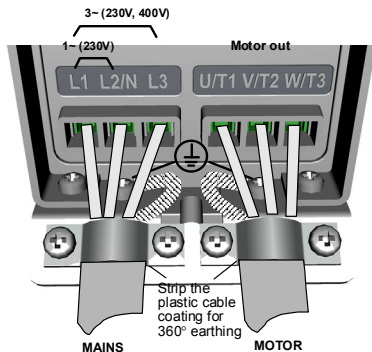

Figure 3.7:

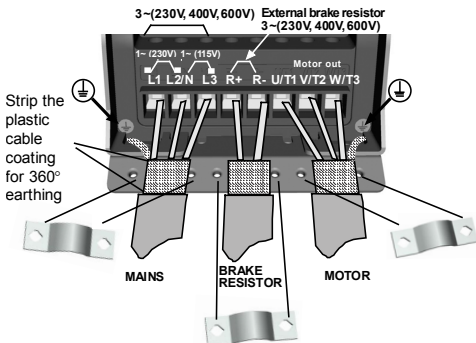

Figure 3.8: Vacon 10 power connections, MI2 - MI3

3.2.2 Control cabling

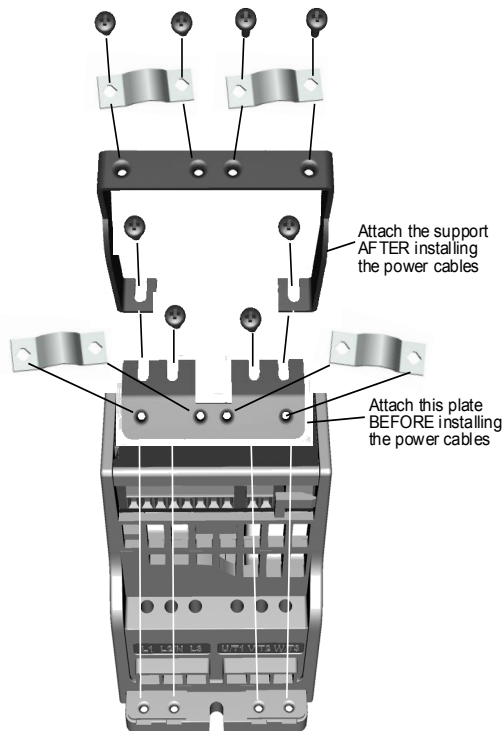

Figure 3.9: Mount the PE-plate and API cable support, MI1 - MI3

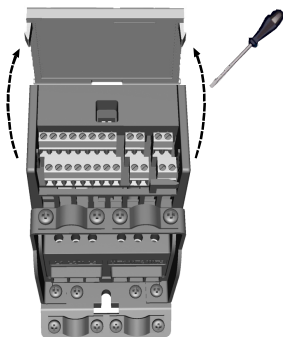

Figure 3.10: Open the lid, MI1 - MI3

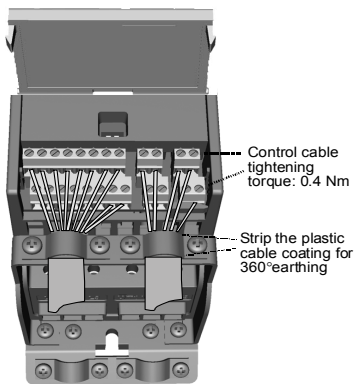

Figure 3.11: Install the control cables. MI1 - MI3. See Chapter 6.2

3.2.3 Screw of cables

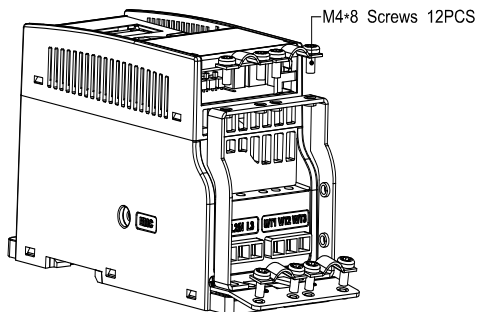

Figure 3.12: MI1 screws

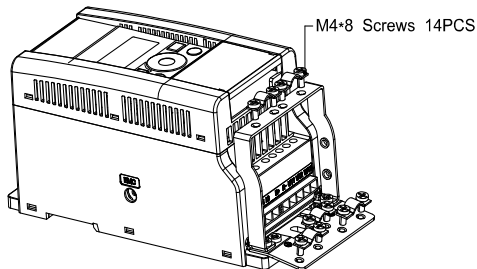

Figure 3.13: MI2 screws

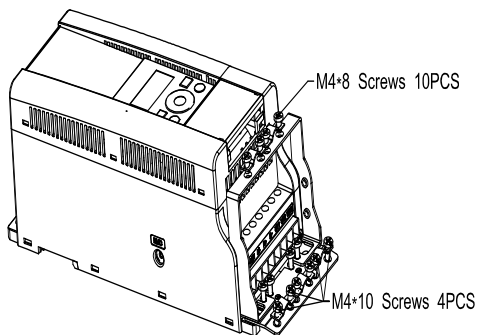

Figure 3.14: M13 screws

3.2.4 Cable and fuse specifications

Use cables with heat resistance of at least +70°C. The cables and the fuses must be dimensioned according to the tables below. Installation of cables according to UL regulations is presented in Chapter Cable installation and the UL standards.

The fuses function also as cable overload protection.

These instructions apply only to cases with one motor and one cable connection from the frequency converter to the motor. In any other case, ask the factory for more information.

EMC category	cat. C2	cat. C4
Mains cable types	1	1
Motor cable types	3	1
Control cable types	4	4

Table 3.7: Cable types required to meet standards. EMC categories are described in Chapter EMC levels

Cable type	Description
1	Power cable intended for fixed installation and the specific mains voltage. Shielded cable not required. (NKCABLES / MCMK or similar recommended)
2	Power cable equipped with concentric protection wire and intended for the specific mains voltage. (NKCABLES / MCMK or similar recommended).
3	Power cable equipped with compact low-impedance shield and intended for the specific mains voltage. (NKCABLES / MCCMK, SAB / ÖZCUY-J or similar recommended). *360° earthing of both motor and FC connection required to meet the standard
4	Screened cable equipped with compact low-impedance shield (NKCA-BLES / Jamak, SAB / ÖZCuY-0 or similar).

Table 3.8: Cable type descriptions

Frame	Type	Fuse [A]	Mains cable Cu [mm ²]	Motor cable Cu [mm ²]	Terminal cable size (min/max)			
					Main terminal [mm ²]	Earth terminal [mm ²]	Control terminal [mm ²]	Relay terminal [mm ²]
MI2	0001-0004	20	2*2.5+2.5	3*1.5+1.5	1.5-4	1.5-4	0.5-1.5	0.5-1.5
MI3	0005	32	2*6+6	3*1.5+1.5	1.5-4	1.5-4	0.5-1.5	0.5-1.5

Table 3.9: Cable and fuse sizes for Vacon 10, 115 V, 1~

Frame	Type	Fuse [A]	Mains cable Cu [mm ²]	Motor cable Cu [mm ²]	Terminal cable size (min/max)			
					Main terminal [mm ²]	Earth terminal [mm ²]	Control terminal [mm ²]	Relay terminal [mm ²]
MI1	0001-0003	10	2*1.5+1.5	3*1.5+1.5	1.5-4	1.5-4	0.5-1.5	0.5-1.5
MI2	0004-0007	20	2*2.5+2.5	3*1.5+1.5	1.5-4	1.5-4	0.5-1.5	0.5-1.5
MI3	0009	32	2*6+6	3*1.5+1.5	1.5-6	1.5-6	0.5-1.5	0.5-1.5

Table 3.10: Cable and fuse sizes for Vacon 10, 208 - 240 V, 1~

Frame	Type	Fuse [A]	Mains cable Cu [mm ²]	Motor cable Cu [mm ²]	Terminal cable size (min/max)			
					Main terminal [mm ²]	Earth terminal [mm ²]	Control terminal [mm ²]	Relay terminal [mm ²]
MI1	0001-0003	6	3*1.5+1.5	3*1.5+1.5	1.5-4	1.5-4	0.5-1.5	0.5-1.5
MI2	0004-0007	10	3*1.5+1.5	3*1.5+1.5	1.5-4	1.5-4	0.5-1.5	0.5-1.5
MI3	0011	20	3*2.5+2.5	3*2.5+2.5	1.5-6	1.5-6	0.5-1.5	0.5-1.5

Table 3.11: Cable and fuse sizes for Vacon 10, 208 - 240 V, 3~

Frame	Type	Fuse [A]	Mains cable Cu [mm ²]	Motor cable Cu [mm ²]	Terminal cable size (min/max)			
					Main terminal [mm ²]	Earth terminal [mm ²]	Control terminal [mm ²]	Relay terminal [mm ²]
MI1	0001-0003	6	3*1.5+1.5	3*1.5+1.5	1.5-4	1.5-4	0.5-1.5	0.5-1.5
MI2	0004-0006	10	3*1.5+1.5	3*1.5+1.5	1.5-4	1.5-4	0.5-1.5	0.5-1.5
MI3	0008-0012	20	3*2.5+2.5	3*2.5+2.5	1.5-6	1.5-6	0.5-1.5	0.5-1.5

Table 3.12: Cable and fuse sizes for Vacon 10, 380 - 480 V, 3~

Frame	Type	Fuse [A]	Mains cable Cu [mm ²]	Motor cable Cu [mm ²]	Terminal cable size (min/max)			
					Main terminal [mm ²]	Earth terminal [mm ²]	Control terminal [mm ²]	Relay terminal [mm ²]
MI3	0002-0004	6	3*1.5+1.5	3*1.5+1.5	1.5-4	1.5-4	0.5-1.5	0.5-1.5
MI3	0005-0006	10	3*1.5+1.5	3*1.5+1.5	1.5-4	1.5-4	0.5-1.5	0.5-1.5
MI3	0009	20	3*2.5+2.5	3*2.5+2.5	1.5-6	1.5-6	0.5-1.5	0.5-1.5

Table 3.13: Cable and fuse sizes for Vacon 10, 600 V, 3~

Note! To fulfil standard EN61800-5-1, the protective conductor should be at least 10 mm² Cu or 16 mm² Al. Another possibility is to use an additional protective conductor of at least the same size as the original one.

3.2.5 General cabling rules

1	Before starting the installation, check that none of the components of the frequency converter is live.
2	Place the motor cables sufficiently far from other cables: <ul style="list-style-type: none"> • Avoid placing the motor cables in long parallel lines with other cables. • If the motor cable runs in parallel with other cables, the minimum distance between the motor cable and other cables is 0.3 m. • The given distance also applies between the motor cables and signal cables of other systems. • The maximum length of the motor cables for MI1-3 is 30 m. If use longer cable, current accuracy will be decreased. • The motor cables should cross other cables at an angle of 90 degrees.
3	If cable insulation checks are needed, see Chapter Cable and motor insulation checks.
4	Connecting the cables: <ul style="list-style-type: none"> • Strip the motor and mains cables as advised in Figure Stripping of cables. • Connect the mains, motor and control cables into their respective terminals, see Figures Vacon 10 power connections, MI1 - Install the control cables. • Note the tightening torques of chapter 3.2.1 power cables and chapter 3.2.2 control cables given in Vacon 10 power connections, MI1 and Install the control cables. MI1 - MI3. See Chapter 6.2. • For information on cable installation according to UL regulations see Chapter Cable installation and the UL standards. • Make sure that the control cable wires do not come in contact with the electronic components of the unit. • If an external brake resistor (option) is used, connect its cable to the appropriate terminal. • Check the connection of the earth cable to the motor and the frequency converter terminals marked with  • Connect the separate shield of the motor cable to the earth plate of the frequency converter, motor and the supply centre.

3.2.6 Stripping lengths of motor and mains cables

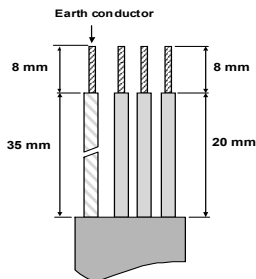

Figure 3.15: Stripping of cables

Note! Strip also the plastic cover of the cables for 360 degree earthing. See Figures Vacon 10 power connections, MI1, Vacon 10 power connections, MI2 - MI3 and Install the control cables. MI1 - MI3. See Chapter 6.2.

3.2.7 Cable installation and the UL standards

To meet the UL (Underwriters Laboratories) regulations, a UL-approved copper cable with a minimum heat-resistance of +60 / 75°C must be used.

Use Class 1 wire only.

The units are suitable for use on a circuit capable of delivering not more than 50,000 rms symmetrical amperes, 600V maximum, when protected by T and J Class fuses.

Integral solid state short circuit protection does not provide branch circuit protection. Branch circuit protection must be provided in accordance with the National Electric Code and any additional local codes. Branch circuit protection provided by fuses only.

Motor overload protection provided at 110% of full load current.

3.2.8 Cable and motor insulation checks

These checks can be performed as follows if motor or cable insulations are suspected to be faulty.

1. Motor cable insulation checks

Disconnect the motor cable from terminals U / T1, V / T2 and W / T3 of the frequency converter and from the motor. Measure the insulation resistance of the motor cable between each phase conductor as well as between each phase conductor and the protective ground conductor.

The insulation resistance must be >1 MOhm.

2. Mains cable insulation checks

Disconnect the mains cable from terminals L1, L2 / N and L3 of the frequency converter and from the mains. Measure the insulation resistance of the mains cable between each phase conductor as well as between each phase conductor and the protective ground conductor. The insulation resistance must be >1 MΩm.

3. Motor insulation checks

Disconnect the motor cable from the motor and open the bridging connections in the motor connection box. Measure the insulation resistance of each motor winding. The measurement voltage must equal at least the motor nominal voltage but not exceed 1000 V. The insulation resistance must be >1 MΩm.

4. COMMISSIONING

Before commissioning, read the warnings and instructions listed in Chapter 1!

4.1 Commissioning steps of Vacon 10

1	Read carefully the safety instructions in Chapter 1 and follow them.
2	<p>After the installation, make sure that:</p> <ul style="list-style-type: none"> • both the frequency converter and the motor are grounded. • the mains and motor cables comply with the requirements given in Chapter 3.2.4. • the control cables are located as far as possible from the power cables (see Chapter 3.2.5, step 2) and the shields of the shielded cables are connected to protective earth. <div style="text-align: center;">  </div>
3	Check the quality and quantity of cooling air (Chapter 3.1.2).
4	Check that all Start / Stop switches connected to the I / O terminals are in Stop -position.
5	Connect the frequency converter to mains.
6	<p>Set the parameters of group 1 according to the requirements of your application. At least the following parameters should be set:</p> <ul style="list-style-type: none"> • motor nominal speed (par. 1.3) • motor nominal current (par. 1.4) • application type (par. 17.1) <p>You will find the values needed for the parameters on the motor rating plate.</p>

7	<p>Perform test run without motor. Perform either Test A or Test B:</p> <p>A) Control from the I / O terminals:</p> <ul style="list-style-type: none">• Turn the Start / Stop switch to ON position.• Change the frequency reference.• Check the Monitoring Menu and make sure that the value of Output frequency changes according to the change of frequency reference.• Turn the Start / Stop switch to OFF position. <p>B) Control from the keypad:</p> <ul style="list-style-type: none">• Select the keypad as the control place by pressing Loc / Rem button or select Local control with par 2.5.• Push the Start button on the keypad.• Check the Monitoring Menu and make sure that the value of Output frequency changes according to the change of frequency reference.• Push the Stop button on the keypad.
8	<p>Run the no-load tests without the motor being connected to the process, if possible. If this is impossible, secure the safety of each test prior to running it. Inform your co-workers of the tests.</p> <ul style="list-style-type: none">• Switch off the supply voltage and wait up until the drive has stopped.• Connect the motor cable to the motor and to the motor cable terminals of the frequency converter.• See to that all Start / Stop switches are in Stop positions.• Switch the mains ON.• Repeat test 7A or 7B.
9	<p>Perform an identification run (see par. 1.18), especially if the application requires a high startup torque or a high torque with low speed.</p>
10	<p>Connect the motor to the process (if the no-load test was running without the motor being connected).</p> <ul style="list-style-type: none">• Before running the tests, make sure that this can be done safely.• Inform your co-workers of the tests.• Repeat test 7A or 7B.

5. FAULT TRACING

When a fatal fault is detected by the frequency converter control electronics, the drive will stop and the symbol FT and the fault code blinked on the display are in the following format, e.g.:

FT 2

Fault code (2 = overvoltage)

The active fault can be reset by pressing BACK / RESET button when the API is in active fault menu level (FT XX), or pressing BACK / RESET button with long time (> 2 s) when the API is in active fault submenu level (F5.x), or via the I / O terminal or field bus. Reset fault history (long push > 5 s), when the API is in fault history submenu level (F6.x). The faults with subcode and time labels are stored in the Fault history submenu which can be browsed. The different fault codes, their causes and correcting actions are presented in the table below.

Fault code	Fault name	Possible cause	Correcting actions
1	Overcurrent	Frequency converter has detected too high a current ($>4 \cdot I_N$) in the motor cable: <ul style="list-style-type: none"> • sudden heavy load increase • short circuit in motor cables • unsuitable motor 	Check loading. Check motor size. Check cables.
2	Overvoltage	The DC-link voltage has exceeded the internal safety limit: <ul style="list-style-type: none"> • deceleration time is too short • high overvoltage spikes in mains 	Increase the deceleration time (Par.4.3 or Par.4.6)
3	Earth fault	Current measurement has detected extra leakage current at start: <ul style="list-style-type: none"> • insulation failure in cables or motor 	Check motor cables and motor

Table 5.1: Fault codes

Fault code	Fault name	Possible cause	Correcting actions
8	System fault	<ul style="list-style-type: none"> • component failure • faulty operation 	Reset the fault and restart. If the fault re-occurs, contact the distributor near to you. NOTE! If fault F8 occurs, find out the subcode of the fault from the Fault History menu under Id xxx!
9	Undervoltage	The DC-link voltage has gone below the internal safety limit: <ul style="list-style-type: none"> • most probable cause: supply voltage is too low • frequency converter internal fault • Power outages 	In case of temporary supply voltage break reset the fault and restart the frequency converter. Check the supply voltage. If it is adequate, an internal failure has occurred. Contact the distributor near to you.
11	Output phase fault	Current measurement has detected that there is no current in one motor phase.	Check motor cable and motor.
13	Frequency converter undertemperature	Heat sink temperature is under -10 °C	Check the ambient temperature.
14	Frequency converter overtemperature	Heat sink is overheated.	Check that the cooling air flow is not blocked. Check the ambient temperature. Make sure that the switching frequency is not too high in relation to ambient temperature and motor load.
15	Motor stalled	Motor stall protection has tripped.	Check that the motor is able to rotate freely.
16	Motor overtemperature	Motor overheating has been detected by frequency converter motor temperature model. Motor is overloaded.	Decrease the motor load. If no motor overload exists, check the temperature model parameters.
17	Motor underload	Motor underload protection has tripped.	Check motor and load, e.g. for broken belts or dry pumps.

Table 5.1: Fault codes

Fault code	Fault name	Possible cause	Correcting actions
22	EEPROM check sum fault	Parameter save fault <ul style="list-style-type: none"> • faulty operation • component failure Note: Alarm 22 is issued for calibration data CRC check.	Contact the distributor near to you.
25	Microcontroller watchdog fault	<ul style="list-style-type: none"> • faulty operation • component failure 	Reset the fault and restart. If the fault re-occur, contact the distributor near to you.
27	Back EMF protection	Drive has detected that the magnetized motor is running in start situation. <ul style="list-style-type: none"> • A rotating PM-motor 	Make sure that there is no rotating PM-motor when the start command is given.
29	Thermistor fault	The thermistor input of option board has detected increase	Check motor cooling and loading. Check thermistor connection (If thermistor input of the option board is not in use it has to be short circuited).
34	Internal bus communication	Ambient interference or defective hardware	If the fault re-occur, contact the distributor near to you.
35	Application fault	Application is not working properly.	Contact the distributor near to you.
41	IGBT Overtemperature	Over temperature alarm is issued when the IGBT switch temperature exceeds 110 °C.	Check loading. Check motor size. Make identification run.
50	Analog input select 20% - 100% (selected signal range 4 to 20 mA or 2 to 10 V)	Current at the analogue input is < 4mA; Voltage at the analogue input is < 2 V. <ul style="list-style-type: none"> • control cable is broken or loose. • signal source has failed. 	Check the current loop circuitry.
51	External fault	Digital input fault. Digital input has been programmed as external fault input and this input is active.	Remove the external device fault.
53	Fieldbus fault	The data connection between the fieldbus Master and the fieldbus of the drive has broken.	Check installation. If installation is correct, contact the nearest Vacon distributor.

Table 5.1: Fault codes

Fault code	Fault name	Possible cause	Correcting actions
55	Wrong run fault (FWD/REV conflict)	Run forward and backward at the same time.	Check I/O control single 1 and I/O control single 2. Single 1 should be changed to signal 1, single 2 should be changed to signal 2.
57	Identification fault	Identification run has failed.	Run command was removed before completion of identification run. Motor is not connected to frequency converter. There is load on motor shaft.
111	Temperature fault	Over low or over high temperature	Check temperature signal from OPTBH board

Table 5.1: Fault codes

F08 SubCode	Fault
82	MPI RX buffer overflow
84	MPI CRC
86	MPI2 CRC
87	MPI2 message buffer overflow
96	MPI queue full
97	MPI off line error
101	MODBUS out of buffer
115	Device Property data format tree too deep exceed 3

Table 5.2: Fault Subcode

F22 SubCode	Fault
1	DA_CN, Power down data counter error
2	DA_PD, Power down data restore fail
3	DA_FH, Fault history data error
4	DA_PA, Restore parameter CRC error

Table 5.2: Fault Subcode

6. VACON 10 APPLICATION INTERFACE

6.1 Introduction

There is only one version of Control Board available for the Vacon 10 drive:

Version	Composition
Vacon 10	6 Digital inputs
	2 Analogue inputs
	1 Analogue output
	1 Digital output
	2 Relay outputs
	RS-485 Interface

Table 6.1: Available Control Board

This section provides you with a description of the I / O-signals for Vacon 10 and instructions for using the Vacon 10 general purpose application.

The frequency reference can be selected from Preset Speed 0-7, Keypad, Fieldbus, AI1, AI2, PI.

Basic properties:

- Digital inputs DI1...DI6 are freely programmable. The user can assign a single input to many functions.
- Digital-, relay- and analogue outputs are freely programmable.
- Analog output can be set as current output.
- Analog input 1 can be set as voltage input and Analog input 2 can be set as current input.

Special features:

- Programmable Start / Stop and Reverse signal logic
- Reference scaling
- DC-brake at start and stop
- Programmable U / f curve
- Adjustable switching frequency
- Auto reset function after fault

- Protections and supervisions (all fully programmable; off, alarm, fault):
 - Analog input low fault
 - Undervoltage fault
 - Earth fault
 - Output phase fault
 - Motor thermal, stall and underload protection
- 8 preset speeds
- Analogue input range selection, signal scaling and filtering
- PI controller

6.2 Control I/O

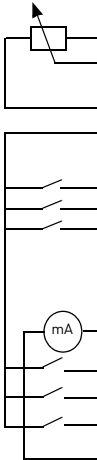

Terminal	Signal	Factory preset	Description
1	+10Vref		Ref. voltage out
2	AI1		Analog signal in 1
3	GND		I/O signal ground
6	24Vout		24V output for DI's
7	GND		I/O signal ground
8	DI1	Start forward ^{PI}	positive: Logic1: 8...30V; Logic0: 0...1.5V, Ri = 20 kΩ
9	DI2	Start reverse ^{PI}	
10	DI3	Fault reset ^{PI}	
A	A	RS485 signal A	FB Communication
B	B	RS485 signal B	FB Communication
4	AI2		Analog signal in 2
5	GND		I/O signal ground
13	GND		I/O signal ground
14	DI4	Preset speed B0 ^{PI}	Positive: Logic1: 8...30V; Logic0: 0...1.5V, Ri = 20 kΩ
15	DI5	Preset speed B1 ^{PI}	
16	DI6	External fault ^{PI}	
18	AO		Analog Output
20	DO		Digital signal out
22	R01 NO		Relay out 1
23	R01 CM		
24	R02 NC		Relay out 2
25	R02 CM		
26	R02 NO		

Table 6.2: Vacon 10 default I/O configuration and connections
 P) = Programmable function, see parameter lists and descriptions,
 chapters 8 and 9.

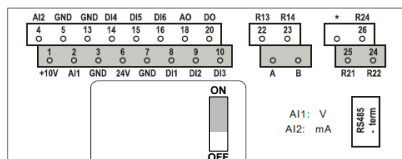

Figure 6.1: Vacon 10 I/O

7. CONTROL PANEL

7.1 General

The panel is an irremovable part of the drive consisting of corresponding control board; The overlay with display status on the cover and the button are in clarifications in the user language.

The User Panel consists of an alphanumeric LCD display with backlight and a keypad with the 9 push buttons (see Figure 7.1).

7.2 Display

The display includes 14-segment and 7-segment blocks, arrowheads and clear text unit symbols. The arrowheads, when visible, indicate some information about the drive, which is printed in clear text in user language on the overlay (numbers 1...14 in the figure below). The arrowheads are grouped in 3 groups with the following meanings and English overlay texts (see Figure 7.1):

Group 1 - 5; Drive status

- 1 = Drive is ready to start (READY)
- 2 = Drive is running (RUN)
- 3 = Drive has stopped (STOP)
- 4 = Alarm condition is active (ALARM)
- 5 = Drive has stopped due to a fault (FAULT)

Group 6 - 10; Control selections

- 6 = Motor is rotating forward (FWD)
- 7 = Motor is rotating reverse (REV)
- 8 = I/O terminal block is the selected control place (I / O)
- 9 = Keypad is the selected control place (KEYPAD)
- 10 = Fieldbus is the selected control place (BUS)

Group 11 - 14; Navigation main menu

- 11 = Reference main menu (REF)
- 12 = Monitoring main menu (MON)
- 13 = Parameter main menu (PAR)
- 14 = System main menu (SYS)



Figure 7.1: Vacon 10 Control panel

7.3 Keypad

The keypad section of the control panel consists of 9 buttons (see Figure 7.1). The buttons and their functions are described as Table 7.1.

The drive stops by pressing the keypad STOP button.

The drive starts by pressing the keypad START button when the selected control place is KEYPAD.









Symbol	Button Name	Function Description
	Start	Motor START from the panel
	STOP	Motor STOP from the panel
	OK	Used for confirmation. Enter edit mode for parameter Alternate in display between the parameter value and parameter code. Reference frequency value adjusting no need to press OK-button to confirm
	Back / Reset	Cancels edited parameter Move backwards in menu levels Reset fault indication
 	Up and Down	Select root parameter number on root- parameter list, Up decrease / Down increase parameter number, Up increase / Down decrease parame- ter value change
 	Left and Right	Available in REF,PAR and SYS menu parameter digit setting when changing value MON,PAR and SYS can also use left and right button to navigate the parameter group, like in MON menu use right but- ton from V1.x to V2.x to V3.x Can be used to change direction in REF menu in local mode: - Right arrow would mean reverse (REV) - Left arrow would mean forward (FWD)
	Loc / Rem	Change control place

Table 7.1: Keypad Function

NOTE! The status of all the 9 buttons are available for application program!

7.4 Navigation on the Vacon 10 control panel

This chapter provides you with information on navigating the menus on Vacon 10 and editing the values of the parameters.

7.4.1 Main menu

The menu structure of Vacon 10 control software consists of a main menu and several submenus. Navigation in the main menu is shown below:

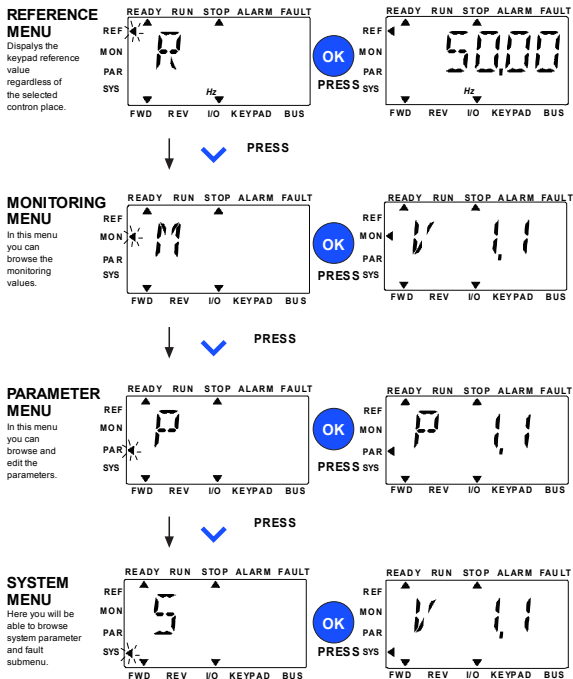

Figure 7.2: The main menu of Vacon 10

7.4.2 Reference menu

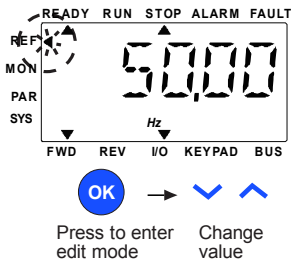

Figure 7.3: Reference menu display

Move to the reference menu with the UP / DOWN button (see Figure 7.2). The reference value can be changed with UP / DOWN button as shown in Figure 7.3. If the value has big change, first press Left and Right buttons to select the digit which has to be changed, then press Up button to increase and Down button to decreases the value in the selected digit. When the drive is in run mode, the reference value changed by Up/Down/Left/Right button will take effective no need to press OK button.

Note! LEFT and RIGHT buttons can be used to change the direction in Ref menu in local control mode.

7.4.3 Monitoring menu

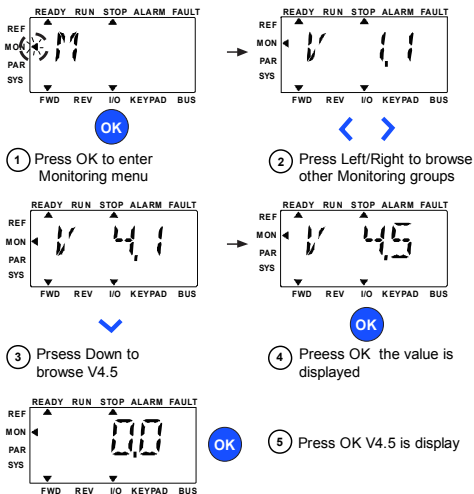

Figure 7.4: Monitoring menu display

Monitoring values are actual values of measured signals as well as status of some control settings. It is visible in Vacon 10 display, but it can not be edited. The monitoring values are listed in Table 7.2.

Pressing Left/Right button to change the actual parameter to the first parameter of the next group, to browse monitor menu from V1.x to V2.1 to V4.1. After entering the desired group, the monitoring values can be browsed by pressing UP/DOWN button, as shown in Figure 7.4.

In MON menu the selected signal and its value are alternating in the display by pressing OK button.

Note! Turn on drive power, arrowhead of main menu is at MON, V x.x or monitor parameter value of Vx.x is displayed in Panel.

Display Vx.x or monitor parameter value of Vx.x is determined by the last show status before power shut down. E.g., it was V4.5, and it is also V4.5 when restart.

Code	Monitoring signal	Unit	ID	Description
V1.1	Output frequency	Hz	1	Output frequency to motor
V1.2	Frequency reference	Hz	25	Frequency reference to motor control
V1.3	Motor speed	rpm	2	Calculated motor speed
V1.4	Motor current	A	3	Measured motor current
V1.5	Motor torque	%	4	Calculated actual / nominal torque of the motor
V1.6	Motor Power	%	5	Calculated actual / nominal power of the motor
V1.7	Motor voltage	V	6	Motor voltage
V1.8	DC-link voltage	V	7	Measured DC-link voltage
V1.9	Drive temperature	°C	8	Heatsink temperature
V1.10	Motor temperature	%	9	Calculated motor temperature
V2.1	Analog input 1	%	59	A11 signal range in percent of used range
V2.2	Analog input 2	%	60	A12 signal range in percent of used range
V2.3	Analog output	%	81	A0 signal range in percent of used range
V2.4	Digital input status DI1, DI2, DI3		15	Digital input status
V2.5	Digital input status DI4, DI5, DI6		16	Digital input status
V2.6	R01, R02, D0		17	Relay / digital output status
V4.1	PI setpoint	%	20	Regulator setpoint
V4.2	PI feedback value	%	21	Regulator actual value
V4.3	PI error	%	22	Regulator error
V4.4	PI output	%	23	Regulator output

Table 7.2: Vacon 10 monitoring signals

7.4.4 Parameter menu

In Parameter menu only the Quick setup parameter list is shown as default. By giving the value 0 to the parameter 17.2, it is possible to open other advanced parameter groups. The parameter lists and descriptions can be found in chapters 8 and 9.

The following figure shows the parameter menu view:

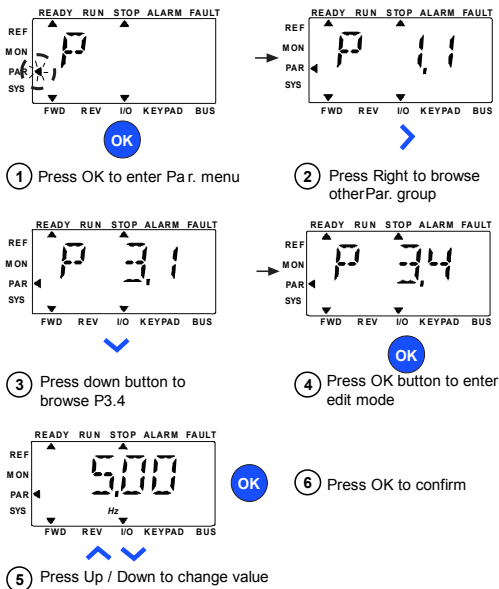

Figure 7.5: Parameter menu

The parameter can be changed as the Figure 7.5.

Left / Right button is available inside Parameter menu. Pressing Left / Right button to change the actual parameter to the first parameter of the next group (Example: any parameter of P1... is displayed -> RIGHT button -> P2.1 is displayed -> RIGHT button -> P3.1 is displayed ...). After entering the desired group, pressing UP / DOWN button to select root parameter number, and then press OK button to display the value of the parameter and also enter edit mode.

In edit mode, Left and Right buttons are used to select the digit which has to be changed, and Up increases / Down decreases parameter value.

In edit mode, the value of Px.x is displayed blinkingly in the panel. After about 10 s, Px.x is displayed in the panel again if you don't press any button.

Note! In edit mode, if you edit the value and don't press OK button, the value isn't changed successfully.

In edit mode, if you don't edit the value, you can press Reset / Back button to display Px.x again.

7.4.5 System menu

SYS menu including fault submenu and system parameter submenu, and the display and operation of the system parameter submenu is similar to PAR menu or MON menu. In system parameter submenu, there are some editable parameter (P) and some uneditable parameter (V).

The Fault submenu of SYS menu includes active fault submenu and fault history submenu.

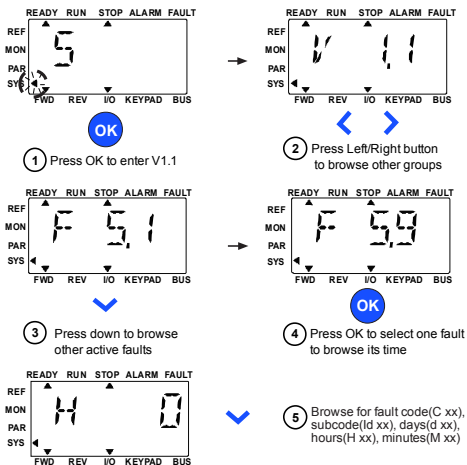

Figure 7.6: Fault menu

In active fault situation, FAULT arrow is blinking and the display is blinking active fault menu item with fault code. If there are several active faults, you can check it by entering the active fault submenu F5.x. F5.1 is always the latest active fault code. The active faults can be reset by pressing BACK / RESET button with long time (>2 s), when the API is in active fault submenu level (F5.x). If the fault cannot be reset, the blinking continues. It is possible to select other display menus during active fault, but in this case the display returns automatically to the fault menu if no button is pressed in 10 seconds. The fault code, subcode and the operating day, hour and minute values at the fault instant are shown in the value menu [operating hours = displayed reading].

Note! Fault History can be reset by long pressing the BACK / RESET button for 5 second time,when the API is in fault history sub-menu level (F6.x), it will also clear all active faults.

See Chapter5 for fault descriptions

8. STANDARD APPLICATION PARAMETERS

On the next pages you can find the lists of parameters within the respective parameter groups. The parameter descriptions are given in Chapter 9 .

Explanations:

Code: Location indication on the keypad; Shows the operator the present Monitoring value number or Parameter number

Parameter: Name of monitoring value or parameter

Min: Minimum value of parameter

Max: Maximum value of parameter

Unit: Unit of parameter value; given if available

Default: Factory preset value

ID: ID number of the parameter (used with fieldbus control)



More information on this parameter available in chapter 9: 'Parameter descriptions' click on the parameter name.



Modifiable only in stop state

NOTE: This manual is for Vacon 10 standard application only. please download the appropriate user manuals on <http://www.vacon.com> -> Support & Download if special application details needed.

8.1 Quick setup parameters (Virtual menu, shows when par. 17.2 = 1)

Code	Parameter	Min	Max	Unit	Default	ID	Note
P1.1	Motor nominal voltage	180	690	V	Varies	110	Check rating plate on the motor.
P1.2	Motor nominal frequency	30,00	320,00	Hz	50,00 / 60,00	111	Check rating plate on the motor.
P1.3	Motor nominal speed	30	20000	rpm	1440 / 1720	112	Default applies for a 4-pole motor.
P1.4	Motor nominal current	0,2 x I _{Nunit}	2,0 x I _{Nunit}	A	I _{Nunit}	113	Check rating plate on the motor.
P1.5	Motor cos Φ (Power Factor)	0,30	1,00		0,85	120	Check rating plate on the motor.
i P1.7	Current limit	0,2 x I _{Nunit}	2,0 x I _{Nunit}	A	1,5 x I _{Nunit}	107	Maximum motor current
i P1.15	Torque boost	0	1		0	109	0 = Not used 1 = Used
i P2.1	Remote control place selection	0	1		0	172	0 = I / O terminal 1 = Fieldbus
i P2.2	Start function	0	1		0	505	0 = Ramp 1 = Flying start
i P2.3	Stop function	0	1		0	506	0 = Coasting 1 = Ramp
P3.1	Min frequency	0,00	P3.2	Hz	0,00	101	Minimum freq reference
P3.2	Max frequency	P3.1	320,00	Hz	50,00 / 60,00	102	Maximum freq reference
i P3.3	Remote Control Place frequency reference selection	1	6		4	117	1 = Preset speed 0-7 2 = Keypad 3 = Fieldbus 4 = AI1 5 = AI2 6 = PI
i P3.4	Preset speed 0	P3.1	P3.2	Hz	5,00	180	Activated by digital inputs
i P3.5	Preset speed 1	P3.1	P3.2	Hz	10,00	105	Activated by digital inputs
i P3.6	Preset speed 2	P3.1	P3.2	Hz	15,00	106	Activated by digital inputs
i P3.7	Preset speed 3	P3.1	P3.2	Hz	20,00	126	Activated by digital inputs

Table 8.1: Quick setup parameters

Code	Parameter	Min	Max	Unit	Default	ID	Note
P4.2	Acceleration time 1	0,1	3000,0	s	3,0	103	Acceleration time from 0 Hz to maximum frequency.
P4.3	Deceleration time 1	0,1	3000,0	s	3,0	104	Deceleration time from maximum frequency to 0 Hz.
P6.1	AI1 Signal range	0	1		0	379	0 = 0 - 100% 1 = 20% - 100% 20% is the same as 2 V minimum signal level.
P6.5	AI2 Signal range	0	1		0	390	0 = 0 - 100% 1 = 20% - 100% 20% is the same as 4 mA minimum signal level.
P14.1	Automatic reset	0	1		0	731	0 = Disable 1 = Enable
P17.2	Parameter conceal	0	1		1	115	0 = All parameters visible 1 = Only quick setup parameter group visible

Table 8.1: Quick setup parameters

8.2 Motor settings (Control panel: Menu PAR -> P1)











Code	Parameter	Min	Max	Unit	Default	ID	Note
P1.1	Motor nominal voltage	180	690	V	Varies	110	Check rating plate on the motor
P1.2	Motor nominal frequency	30,00	320,00	Hz	50,00 / 60,00	111	Check rating plate on the motor
P1.3	Motor nominal speed	30	20000	rpm	1440 / 1720	112	Default applies for a 4-pole motor.
P1.4	Motor nominal current	0,2 x I _{Nunit}	2,0 x I _{Nunit}	A	I _{Nunit}	113	Check rating plate on the motor
P1.5	Motor cos Φ (Power Factor)	0,30	1,00		0,85	120	Check rating plate on the motor
 P1.7	Current limit	0,2 x I _{Nunit}	2,0 x I _{Nunit}	A	1,5 x I _{Nunit}	107	Maximum motor current
 P1.8	Motor control mode	0	1		0	600	0 = Frequency control 1 = Open loop speed control
 P1.9	U / f ratio	0	2		0	108	0 = Linear 1 = Square 2 = Programmable
 P1.10	Field weakening point	8,00	320,00	Hz	50,00 / 60,00	602	Field weakening point frequency
 P1.11	Field weakening point voltage	10,00	200,00	%	100,00	603	Voltage at field weakening point as % of U _{nmot}
 P1.12	U / f mid point frequency	0,00	P1.10	Hz	50,00 / 60,00	604	Mid point frequency for programmable U / f
 P1.13	U / f mid point voltage	0,00	P1.11	%	100,00	605	Mid point voltage for programmable U / f as % of U _{nmot}
 P1.14	Zero freq voltage	0,00	40,00	%	0,00	606	Voltage at 0 Hz as % of U _{nmot}
 P1.15	Torque Boost	0	1		0	109	0 = Disabled 1 = Enabled
 P1.16	Switching frequency	1,5	16,0	kHz	4,0 / 2,0	601	PWM frequency. If values are higher than default, reduce the current capacity
 P1.17	Brake Chopper	0	2		0	504	0 = Disabled 1 = Enabled: Always 2 = Run state

Table 8.2: Motor settings

Code	Parameter	Min	Max	Unit	Default	ID	Note
i P1.19	Motor identification	0	1		0	631	0 = Not active 1 = Standstill identification (need run command within 20 s to activate)
P1.20	Rs voltage drop	0,00	100,00	%	0,00	662	Voltage drop over motor windings as % of U_{nmot} at nominal current.
i P1.21	Overvoltage controller	0	2		1	607	0 = Disabled 1 = Enabled, Standard mode 2 = Enabled, Shock load mode
i P1.22	Undervoltage controller	0	1		1	608	0 = Disable 1 = Enable
P1.23	Sine filter	0	1		0	522	0 = not in use 1 = in use
P1.24	0	65535			28928	648	Modulator configuration word: B1 = discontinuous modulation (DPWMMIN) B2 = Pulse dropping in overmodulation B6 = under modulation B8 = instantaneous DC voltage compensation* B11 = Low noise B12 = Dead time compensation* B13 = Flux error compensation* *Enable by default

Table 8.2: Motor settings

NOTE! These parameters are shown, when **P17.2 = 0**.

8.3 Start / stop setup (Control panel: Menu PAR -> P2)





Code	Parameter	Min	Max	Unit	Default	ID	Note
 P2.1	Remote Control Place Selection	0	1		0	172	0 = I / O terminals 1 = Fieldbus
 P2.2	Start function	0	1		0	505	0 = Ramp 1 = Flying start
 P2.3	Stop function	0	1		0	506	0 = Coasting 1 = Ramp
 P2.4	I / O Start / Stop logic	0	3		2	300	I / O control signal 1 0 Forward 1 Fwd(Edge) 2 Fwd(Edge) 3 Start I / O control signal 2 Reverse Inverted Stop Rev(Edge) Reverse
 P2.5	Local / Remote	0	1		0	211	0 = Remote control 1 = Local control
P2.6	Keypad control direction	0	1		0	123	0 = Forward 1 = Reverse
P2.9	Keypad button lock	0	1		0	15520	0 = unlock all keypad button 1 = Lock/Rem button locked

Table 8.3: Start / stop setup

8.4 Frequency references (Control panel: Menu PAR -> P3)









Code	Parameter	Min	Max	Unit	Default	ID	Note
P3.1	Min frequency	0,00	P3.2	Hz	0,00	101	Minimum allowed frequency reference
P3.2	Max frequency	P3.1	320,00	Hz	50,00 / 60,00	102	Maximum allowed frequency reference
 P3.3	Remote Control Place frequency reference selection	1	6		4	117	1 = Preset speed 0-7 2 = Keypad 3 = Fieldbus 4 = AI1 5 = AI2 6 = PI
 P3.4	Preset speed 0	P3.1	P3.2	Hz	5,00	180	Activated by digital inputs
 P3.5	Preset speed 1	P3.1	P3.2	Hz	10,00	105	Activated by digital inputs
 P3.6	Preset speed 2	P3.1	P3.2	Hz	15,00	106	Activated by digital inputs
 P3.7	Preset speed 3	P3.1	P3.2	Hz	20,00	126	Activated by digital inputs
 P3.8	Preset speed 4	P3.1	P3.2	Hz	25,00	127	Activated by digital inputs
 P3.9	Preset speed 5	P3.1	P3.2	Hz	30,00	128	Activated by digital inputs
 P3.10	Preset speed 6	P3.1	P3.2	Hz	40,00	129	Activated by digital inputs
 P3.11	Preset speed 7	P3.1	P3.2	Hz	50,00	130	Activated by digital inputs

Table 8.4: Frequency references

NOTE! These parameters are shown, when **P17.2 = 0**.

8.5 Ramps and brakes setup (Control panel: Menu PAR -> P4)

Code	Parameter	Min	Max	Unit	Default	ID	Note
i P4.1	Ramp S-shape	0,0	10,0	s	0,0	500	0 = Linear >0 = S-curve ramp time
P4.2	Acceleration time 1	0,1	3000,0	s	3,0	103	Defines the time required for the output frequency to increase from zero frequency to maximum frequency.
P4.3	Deceleration time 1	0,1	3000,0	s	3,0	104	Defines the time required for the output frequency to decrease from maximum frequency to zero frequency.
P4.4	Ramp S-shape 2	0,0	10,0	s	0,0	501	See the parameter P4.1
P4.5	Acceleration time 2	0,1	3000,0	s	10,0	502	See the parameter P4.2
i P4.6	Deceleration time 2	0,1	3000,0	s	10,0	503	See the parameter P4.3
i P4.7	Flux Braking	0	3		0	520	0 = Off 1 = Deceleration 2 = Chopper 3 = Full Mode
P4.8	Flux Braking Current	0,5 x I_{Nunit}	2,0 x I_{Nunit}	A	I_{Nunit}	519	Defines the current level for flux braking.
P4.9	DC Braking Current	0,3 x I_{Nunit}	2,0 x I_{Nunit}	A	I_{Nunit}	507	Defines the current injected into the motor during DC braking.
i P4.10	Stop DC current time	0,00	600,00	s	0,00	508	Determines if braking is ON or OFF and the braking time of the DC-brake when the motor is stopping. 0,00 = Not active
i P4.11	Stop DC current frequency	0,10	10,00	Hz	1,50	515	The output frequency at which the DC-braking is applied.
i P4.12	Start DC current time	0,00	600,00	s	0,00	516	0,00 = Not active

Table 8.5: Ramps and brakes setup

8.6 Digital inputs (Control panel: Menu PAR -> P5)

Code	Parameter	Min	Max	Unit	Default	ID	Note
P5.1	I/O control signal 1	0	6		1	403	0 = Not used 1 = DI1 2 = DI2 3 = DI3 4 = DI4 5 = DI5 6 = DI6
P5.2	I/O control signal 2	0	6		2	404	As parameter 5.1
P5.3	Reverse	0	6		0	412	As parameter 5.1
P5.4	Ext. fault Close	0	6		6	405	As parameter 5.1
P5.5	Ext. fault Open	0	6		0	406	As parameter 5.1
P5.6	Fault reset	0	6		3	414	As parameter 5.1
P5.7	Run enable	0	6		0	407	As parameter 5.1
P5.8	Preset speed B0	0	6		4	419	As parameter 5.1
P5.9	Preset speed B1	0	6		5	420	As parameter 5.1
P5.10	Preset speed B2	0	6		0	421	As parameter 5.1
P5.11	Ramp time 2 selection	0	6		0	408	As parameter 5.1
P5.12	Disable PI	0	6		0	1020	As parameter 5.1
P5.13	Force to I/O	0	6		0	409	As parameter 5.1

Table 8.6: Digital inputs

8.7 Analogue inputs (Control panel: Menu PAR -> P6)

Code	Parameter	Min	Max	Unit	Default	ID	Note
P6.1	AI1 Signal range	0	1		0	379	0 = 0 - 100% (0 - 10 V) 1 = 20% - 100% (2 - 10 V)
P6.2	AI1 Custom min	-100,00	100,00	%	0,00	380	0,00 = no min scaling
P6.3	AI1 Custom max	-100,00	300,00	%	100,00	381	100,00 = no max scaling
P6.4	AI1 filter time	0,0	10,0	s	0,1	378	0 = no filtering
P6.5	AI2 signal range	0	1		0	390	0 = 0 - 100% (0 - 20 mA) 1 = 20% - 100% (4 - 20 mA)
P6.6	AI2 Custom min	-100,00	100,00	%	0,00	391	0,00 = no min scaling
P6.7	AI2 Custom max	-100,00	300,00	%	100,00	392	100,00 = no max scaling
P6.8	AI2 filter time	0,0	10,0	s	0,1	389	0 = no filtering

Table 8.7: Analogue inputs

8.8 Digital outputs (Control panel: Menu PAR -> P8)

Code	Parameter	Min	Max	Unit	Default	ID	Selections
P8.1	RO1 signal selection	0	11		2	313	0 = Not used 1 = Ready 2 = Run 3 = Fault 4 = Fault Inverted 5 = Warning 6 = Reversed 7 = At Speed 8 = Motor regulator active 9 = FB Control Word.B13 10 = FB Control Word.B14 11 = FB Control Word.B15
P8.2	RO2 signal selection	0	11		3	314	As parameter 8.1
 P8.3	DO1 signal selection	0	11		1	312	As parameter 8.1
P8.4	RO2 inversion	0	1		0	1588	0 = No inversion 1 = Inverted

Table 8.8: Digital outputs

8.9 Analogue outputs (Control panel: Menu PAR -> P9)



Code	Parameter	Min	Max	Unit	Default	ID	Selections
 P9.1	Analog output signal selection	0	4		1	307	0 = Not used 1 = Output freq. $[0-f_{max}]$ 2 = Output current $[0-I_{nMotor}]$ 3 = Motor torque $[0-T_{nMotor}]$ 4 = PI output [0 - 100%]
 P9.2	Analog output minimum	0	1		0	310	0 = 0 mA 1 = 4 mA

Table 8.9: Analogue outputs

8.10 Protections (Control panel: Menu PAR -> P13)

Code	Parameter	Min	Max	Unit	Default	ID	Note
P13.1	Analog Input low fault	0	2		1	700	0 = No action 1 = Alarm 2 = Fault: Coast
P13.2	Under voltage fault	1	2		2	727	1 = No response (no fault generated but drive still stops modulation) 2 = Fault:Coast
P13.3	Earth fault	0	2		2	703	As parameter 13.1
P13.4	Output Phase Fault	0	2		2	702	As parameter 13.1
P13.5	Stall protection	0	2		0	709	As parameter 13.1
P13.6	Under load protection	0	2		0	713	As parameter 13.1
P13.7	Motor thermal protection	0	2		2	704	As parameter 13.1
P13.8	Mtp:Ambient temperature	-20	100	°C	40	705	Environment temperature
P13.9	Mtp:Zero speed cooling	0,0	150,0	%	40,0	706	Cooling as % at 0 speed
P13.10	Mtp:Thermal time constant	1	200	min	45	707	Motor thermal time constant
P13.23	FWD/REV conflict supervision	0	2		1	1463	Same as P13.1

Table 8.10: Protections

NOTE! These parameters are shown, when **P17.2 = 0**.

8.11 Fault autoreset parameters (Control panel: Menu PAR -> P14)

Code	Parameter	Min	Max	Unit	Default	ID	Note
P14.1	Automatic Reset	0	1		0	731	0 = Disabled 1 = Enable
P14.2	Wait time	0,10	10,00	s	0,50	717	Waiting time after fault
P14.3	Trial time	0,00	60,00	s	30,00	718	Maximum time for trials
P14.5	Restart Function	0	2		2	719	0 = Ramping 1 = Flying 2 = From Start Function

Table 8.11: Fault autoreset parameters

NOTE! These parameters are shown, when **P17.2 = 0**.

8.12 PI control parameters (Control panel: Menu PAR -> P15)



Code	Parameter	Min	Max	Unit	Default	ID	Note
P15.1	Setpoint source selection	0	3		0	332	0 = Fixed setpoint % 1 = AI1 2 = AI2 3 = Fiel-bus (ProcessDataIn1)
P15.2	Fixed setpoint	0,0	100,0	%	50,0	167	Fixed setpoint
P15.4	Feedback source selection	0	2		1	334	0 = AI1 1 = AI2 2 = Field-bus (Process-DataIn2)
P15.5	Feedback value minimum	0,0	50,0	%	0,0	336	Value at minimum signal
 P15.6	Feedback value maximum	10,0	300,0	%	100,0	337	Value at maximum signal
 P15.7	P gain	0,0	1000,0	%	100,0	118	Proportional gain
 P15.8	I time	0,00	320,00	s	10,00	119	Integrative time
P15.10	Error inversion	0	1		0	340	0 = Direct (Feedback < Setpoint -> Increase PID output) 1 = Inverted (Feedback > Setpoint -> Decrease PID output)

Table 8.12: PI control parameters

NOTE! These parameters are shown, when P17.2 = 0.

8.13 Application Setting (Control panel: Menu PAR -> P17)

Code	Parameter	Min	Max	Unit	Default	ID	Note
 P17.1	Application Type	0	3		0	540	0 = Basic 1 = Pump 2 = Fan drive 3 = High Torque NOTE! Visible only when Startup wizard is active.
P17.2	Parameter conceal	0	1		1	115	0 = All parameters visible 1 = Only quick setup parameter group visible

Table 8.13: Application Setting parameters

8.14 System parameters

Code	Parameter	Min	Max	Default	ID	Note
Software information (MENU SYS -> V1)						
V1.1	API SW ID				2314	
V1.2	API SW version				835	
V1.3	Power SW ID				2315	
V1.4	Power SW version				834	
V1.5	Application ID				837	
V1.6	Application revision				838	
V1.7	System load				839	
Fieldbus parameter (MENU SYS -> V2)						
V2.1	Communication status				808	Status of Modbus communication. Format: xx.yyy where xx = 0 - 64 (Number of error messages) yyy = 0 - 999 (Number of good messages)
P2.2	Fieldbus protocol	0	1	0	809	0 = Not used 1 = Modbus used
P2.3	Slave address	1	255	1	810	Default setting: None parity, 1 stop bit
P2.4	Baud rate	0	5	5	811	0 = 300 1 = 600 2 = 1200 3 = 2400 4 = 4800 5 = 9600
P2.7	Communication time out	0	255	10	814	1 = 1 sec 2 = 2 secs, etc
P2.8	Reset communication status	0	1	0	815	

Table 8.14: System parameters

Code	Parameter	Min	Max	Default	ID	Note
Other information						
V3.1	MWh counter				827	Million Watt Hour
V3.2	Power on days				828	
V3.3	Power on hours				829	
V3.4	Run counter: Days				840	
V3.5	Run counter: Hours				841	
V3.6	Fault counter				842	
P4.2	Restore factory defaults	0	1	0	831	1 = Restores factory defaults for all parameters
F5.x	Active Fault menu					
F6.x	Fault History menu					

Table 8.14: System parameters

9. PARAMETER DESCRIPTIONS

On the next pages you can find the descriptions of certain parameters. The descriptions have been arranged according to parameter group and number.

9.1 Motor settings (Control panel: Menu PAR -> P1)

1.7 CURRENT LIMIT

This parameter determines the maximum motor current from the frequency converter. To avoid motor overload, set this parameter according to the rated current of the motor. The current limit is equal to $(1.5 \cdot I_n)$ by default.

1.8 MOTOR CONTROL MODE

With this parameter the user can select the motor control mode. The selections are:

0 = Frequency control:

Drive frequency reference is set to output frequency without slip compensation. Motor actual speed is finally defined by motor load.

1 = Open loop speed control:

Drive frequency reference is set to motor speed reference. The motor speed remains the same regardless of motor load. Slip is compensated.

1.9 U / F RATIO

There are three selections for this parameter:

0 = Linear:

The voltage of the motor changes linearly with the frequency in the constant flux area from 0 Hz to the field weakening point where the field weakening point voltage is supplied to the motor. Linear U / f ratio should be used in constant torque applications. See Figure 9.1.

This default setting should be used if there is no special need for another setting.

1 = Square:

The voltage of the motor changes following a squared curve form with the frequency in the area from 0 Hz to the field weakening point where the field weakening point voltage is also supplied to the motor. The motor runs under magnetised below the field weakening point and produces less torque, power losses and electromechanical noise. Squared U/f ratio can be used in applications where torque demand of the load is proportional to the square of the speed, e.g. in centrifugal fans and pumps.

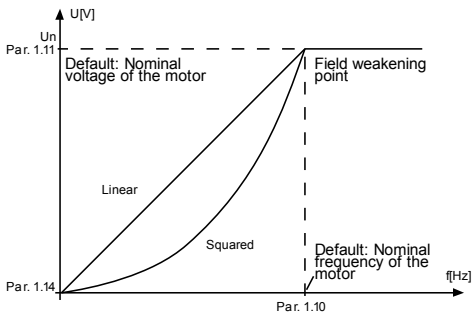

Figure 9.1: Linear and squared change of motor voltage

2 = Programmable U/f curve:

The U/f curve can be programmed with three different points. Programmable U/f curve can be used if the other settings do not satisfy the needs of the application.

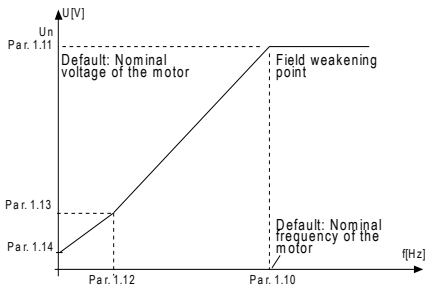

Figure 9.2: Programmable U / f curve

1.10 FIELD WEAKENING POINT

The field weakening point is the output frequency at which the output voltage reaches the value set with par. 1.11.

1.11 FIELD WEAKENING POINT VOLTAGE

Above the frequency at the field weakening point, the output voltage remains at the value set with this parameter. Below the frequency at the field weakening point, the output voltage depends on the setting of the U / f curve parameters. See parameters 1.9-1.14 and Figures 9.1 and 9.2.

When the parameters 1.1 and 1.2 (nominal voltage and nominal frequency of the motor) are set, the parameters 1.10 and 1.11 are automatically given the corresponding values. If you need different values for the field weakening point and the voltage, change these parameters after setting the parameters 1.1 and 1.2.

1.12 U / F MIDDLE POINT FREQUENCY

If the programmable U / f curve has been selected with the parameter 1.9, this parameter defines the middle point frequency of the curve. See Figure 9.2.

1.13 U / F MIDDLE POINT VOLTAGE

If the programmable U / f curve has been selected with the parameter 1.9, this parameter defines the middle point voltage of the curve. See Figure 9.2.

1.14 ZERO FREQUENCY VOLTAGE

This parameter defines the zero frequency voltage of the curve. See Figures 9.1 and 9.2.

1.15 TORQUE BOOST

When this parameter has been activated, the voltage to the motor changes automatically with high load torque which makes the motor produce sufficient torque to start and run at low frequencies. The voltage increase depends on the motor type and power. Automatic torque boost can be used in applications with high load torque, e.g. in conveyors.

0 = Disabled

1 = Enabled

Note: In high torque - low speed applications - it is likely that the motor will overheat. If the motor has to run a prolonged time under these conditions, special attention must be paid to cooling the motor. Use external cooling for the motor if the temperature tends to rise too high.

Note: The best performance can be reached by running motor identification, see par. 1.18.

1.16 SWITCHING FREQUENCY

Motor noise can be minimised using a high switching frequency. Increasing the switching frequency reduces the capacity of the frequency converter unit.

Switching frequency for Vacon 10: 1.5...16 kHz.

1.17 BRAKE CHOPPER

Note! An internal brake chopper is installed in three phase supply MI2 and MI3 size drives.

0 = Disable (No brake chopper used)

1 = Enable: Always (Used in Run and Stop state)

2 = Enable: Run state (Brake chopper used in Run state)

When the frequency converter is decelerating the motor, the energy stored to the inertia of the motor and the load are fed into an external brake resistor, if the brake chopper has been activated. This enables the frequency converter to decelerate the load with a torque equal to that of acceleration (provided that the correct brake resistor has been selected). See separate Brake resistor installation manual.

1.19 MOTOR IDENTIFICATION

0 = Not active

1 = Standstill identification

When Standstill identification is selected, the drive will perform an ID-run when it is started from selected control place. Drive has to be started within 20 seconds, otherwise identification is aborted.

The drive does not rotate the motor during Standstill identification. When ID run is ready the drive is stopped. Drive will start normally, when the next start command is given.

After end the identification, the drive need stop the start command. If control place is Keypad, user need press stop button. If control place is IO, user need put DI(Control signal) inactivate. If control place is fieldbus, user need set the control bit to 0.

The ID run improves the torque calculations and the automatic torque boost function. It will also result in a better slip compensation in speed control [more accurate RPM].

The parameters below will change after ID run successfully,

- a. P1.8 Motor control mode
- b. P1.9 U / f ratio
- c. P1.12 U / f mid point frequency
- d. P1.13 U / f mid point voltage
- e. P1.14 Zero freq voltage
- f. P1.19 Motor identification (1->0)
- g. P1.20 Rs voltage drop

Note! The nameplate data of the motor has to be set BEFORE doing ID run.

1.21 OVERVOLTAGE CONTROLLER

0 = Disabled

1 = Enabled, Standard mode (Minor adjustments of OP frequency are made)

2 = Enabled, Shock load mode (Controller adjusts OP freq. up to max.freq.)

1.22 UNDERVOLTAGE CONTROLLER

0 = Disable

1 = Enable

These parameters allow the under-/overvoltage controllers to be switched out of operation. This may be useful, for example, if the mains supply voltage varies more than -15% to +10% and the application will not tolerate this over-/undervoltage. In this case, the regulator controls the output frequency taking the supply fluctuations into account.

When a value other than 0 is selected also the Closed Loop overvoltage controller becomes active (in Multi-Purpose Control application).

Note! Over-/undervoltage trips may occur when controllers are switched out of operation.

9.2 Start / stop setup (Control panel: Menu PAR -> P2)

2.1 REMOTE CONTROL PLACE SELECTION

With this parameter, the user can select the active control place. Frequency reference can be selected by Parameter P3.3 The selections are:

0 = I / O terminal

1 = Fieldbus

The priority order of selecting the control place is:

1. Force to I/O when the digital input of P5.13 (Force to I/O) is active.
2. Loc/Rem button or P2.5 (Local/Remote) =1.
3. Determined by P2.1 (Remote Control Place Selection).

Note: You can select control place by pressing Loc / Rem button or with par. 2.5, P2.1 will have no effect in local mode.

Local = Keypad is the control place

Remote = I / O terminal or FieldBus

2.2 START FUNCTION

The user can select two start functions for Vacon 10 with this parameter:

0 = Ramp start

The frequency converter starts from 0 Hz and accelerates to the set frequency reference within the set acceleration time [See detailed description: ID103]. (Load inertia, torque or starting friction may cause prolonged acceleration times).

1 = Flying start

The frequency converter is able to start into a running motor by applying small current pulses to motor and searching for the frequency corresponding to the speed the motor is running at. Searching starts from the maximum frequency towards the actual frequency until the correct value is detected. Thereafter, the output frequency will be increased/decreased to the set reference value according to the set acceleration/deceleration parameters.

Use this mode if the motor is coasting when the start command is given. With the flying start it is possible to start the motor from actual speed without forcing the speed to zero before ramping to reference.

2.3 STOP FUNCTION

Two stop functions can be selected in this application:

0 = Coasting

The motor coasts to a halt without control from the frequency converter after the Stop command.

1 = Ramping

After the Stop command, the speed of the motor is decelerated according to the set deceleration parameters.

If the regenerated energy is high it may be necessary to use an external braking resistor for to be able to decelerate the motor in acceptable time.

2.4 I / O START STOP LOGIC

Values 0...3 offer possibilities to control the starting and stopping of the AC drive with digital signal connected to digital inputs. CS = Control signal.

The selections including the text 'edge' shall be used to exclude the possibility of an unintentional start when, for example, power is connected, re-connected after a power failure, after a fault reset, after the drive is stopped by Run Enable (Run Enable = False) or when the control place is changed to I / O control. **The Start / Stop contact must be opened before the motor can be started.**

Selection number	Selection name	Note
0	CS1:Forward CS2:Backward	The functions take place when the contacts are closed.

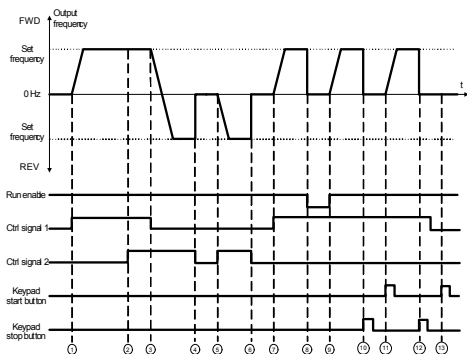

Figure 9.3: Start/Stop logic, selection 0

Explanations			
1	Control signal (CS) 1 activates causing the output frequency to rise. The motor runs forward.	8	Run enable signal is set to FALSE, which drops the frequency to 0. The run enable signal is configured with par. 5.7.
2	CS2 activates which, however, has no effect on the output frequency because the first selected direction has the highest priority.	9	Run enable signal is set to TRUE, which causes the frequency to rise towards the set frequency because CS1 is still active.
3	CS1 is inactivated which caused the direction to start changing (FWD to REV) because CS2 is still active.	10	Keypad stop button is pressed and the frequency fed to the motor drops to 0.
4	CS2 inactivates and the frequency fed to the motor drops to 0.	11	The drive starts through pushing the Start button on the keypad.
5	CS2 activates again causing the motor to accelerate (REV) towards the set frequency.	12	The keypad stop button is pushed again to stop the drive.
6	CS2 inactivates and the frequency fed to the motor drops to 0.	13	The attempt to start the drive through pushing the Start button is not successful because CS1 is inactive.
7	CS1 activates and the motor accelerates (FWD) towards the set frequency.		

Selection number	Selection name	Note
1	CS1:Forward(edge) CS2:Inverted stop	

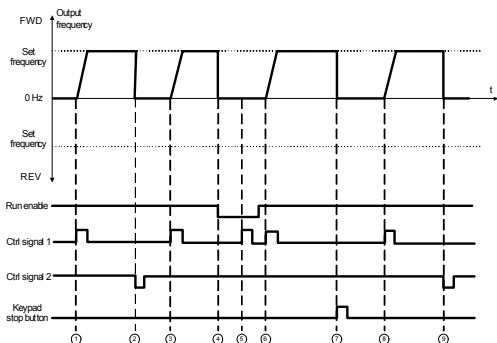

Figure 9.4: Start/Stop logic, selection 1

Explanations			
1	Control signal (CS) 1 activates causing the output frequency to rise. The motor runs forward.	6	CS1 activates and the motor accelerates (FWD) towards the set frequency because the Run enable signal has been set to TRUE.
2	CS2 inactivates causing the frequency to drop to 0.	7	Keypad stop button is pressed and the frequency fed to the motor drops to 0.
3	CS1 activates causing the output frequency to rise again. The motor runs forward.	8	CS1 activates causing the output frequency to rise again. The motor runs forward.
4	Run enable signal is set to FALSE, which drops the frequency to 0. The run enable signal is configured with par. 5.7.	9	CS2 inactivates causing the frequency to drop to 0.
5	Start attempt with CS1 is not successful because Run enable signal is still FALSE.		

Selection number	Selection name	Note
2	CS1:Forward(edge) CS2:Backward(edge)	Shall be used to exclude the possibility of an unintentional start. The Start / Stop contact must be opened before the motor can be restarted.

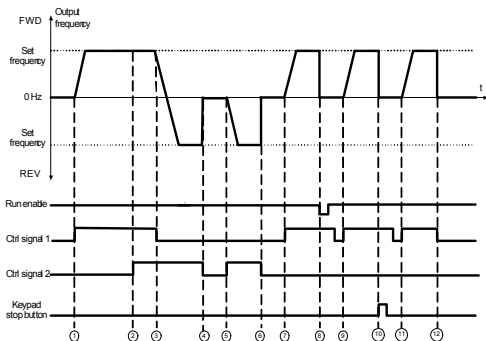

Figure 9.5: Start/Stop logic, selection 2

Explanations:			
1	Control signal (CS) 1 activates causing the output frequency to rise. The motor runs forward.	7	CS1 activates and the motor accelerates (FWD) towards the set frequency.
2	CS2 activates which, however, has no effect on the output frequency because the first selected direction has the highest priority.	8	CS1 activates and the motor accelerates (FWD) towards the set frequency because the Run enable signal has been set to TRUE.
3	CS1 is inactivated which causes the direction to start changing (FWD to REV) because CS2 is still active.	9	CS1 activates again causing the motor to accelerate (REV) towards the set frequency.
4	CS2 inactivates and the frequency fed to the motor drops to 0.	10	CS1 is opened and closed again which causes the motor to start.
5	CS2 activates again causing the motor to accelerate (REV) towards the set frequency.	11	CS1 inactivates and the frequency fed to the motor drops to 0.
6	CS2 inactivates and the frequency fed to the motor drops to 0.		

Selection number	Selection name	Note
3	CS1:Start CS2:Reverse	

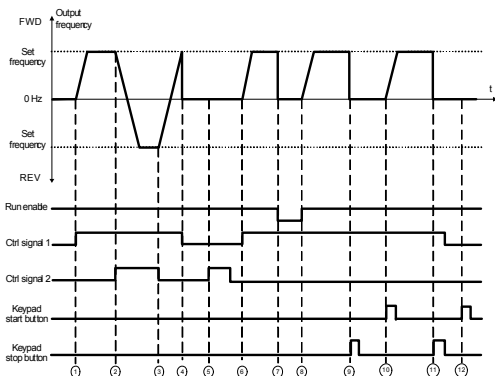

Figure 9.6: Start/Stop logic, selection 3

Explanations:			
1	Control signal (CS) 1 activates causing the output frequency to rise. The motor runs forward.	7	Run enable signal is set to FALSE, which drops the frequency to 0. The run enable signal is configured with par. 5.7.
2	CS2 activates which causes the direction to start changing (FWD to REV).	8	Run enable signal is set to TRUE, which causes the frequency to rise towards the set frequency because CS1 is still active.
3	CS2 is inactivated which causes the direction to start changing (REV to FWD) because CS1 is still active.	9	Keypad stop button is pressed and the frequency fed to the motor drops to 0.
4	Also CS1 inactivates and the frequency drops to 0.	10	The drive starts through pushing the Start button on the keypad.
5	Despite the activates of CS2, the motor does not start because CS1 is inactive.	11	The drive is stopped again with the Stop button on the Keypad.
6	CS1 activates causing the output frequency to rise again. The motor runs forward because CS2 is inactive.	12	The attempt to start the drive through pushing the Start button is not successful because CS1 is inactive.

2.5 LOCAL / REMOTE

This parameter defines whether the control place of the drive is remote (I / O or FieldBus) or local.

0 = Remote Control

1 = Local Control

9.3 Frequency references (Control panel: Menu PAR -> P3)

3.3 REMOTE CONTROL PLACE FREQUENCY REFERENCE SELECTION

It defines the selected frequency reference source when the drive is remote control.

- 1 = Preset speed 0-7
- 2 = Keypad reference
- 3 = Fieldbus Reference
- 4 = AI1
- 5 = AI2
- 6 = PI

3.4 - 3.11 PRESET SPEEDS 0 - 7

Preset speeds 0 - 7 can be used to determine frequency references that are applied when appropriate combinations of digital inputs are activated. Preset speeds can be activated from digital inputs when Par.3.3 (Remote control place frequency reference selection) =1.

Parameter values are automatically limited between the minimum and maximum frequencies. [par. 3.1, 3.2].

Speed	Preset speed B2	Preset speed B1	Preset speed B0
Preset speed 0			
Preset speed 1			x
Preset speed 2		x	
Preset speed 3		x	x
Preset speed 4	x		
Preset speed 5	x		x
Preset speed 6	x	x	
Preset speed 7	x	x	x

Table 9.1: Preset speeds 0 - 7

9.4 Ramps & brakes setup (Control panel: Menu PAR -> P4)

4.1 RAMP S-SHAPE

The start and end of the acceleration and deceleration ramp can be smoothed with this parameter. Setting value 0 gives a linear ramp shape which causes acceleration and deceleration to act immediately to the changes in the reference signal.

Setting value 0.1...10 seconds for this parameter produces an S-shaped acceleration/deceleration. The acceleration and deceleration times are determined with parameters 4.2 and 4.3.

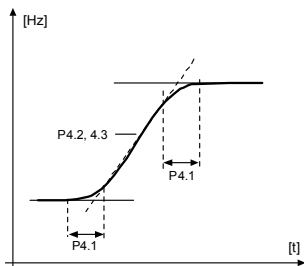

Figure 9.7: S-shaped acceleration/deceleration

4.2 ACCELERATION TIME 1

4.3 DECELERATION TIME 1

4.4 RAMP S-SHAPE 2

4.5 ACCELERATION TIME 2

4.6 DECELERATION TIME 2

These limits correspond to the time required for the output frequency to accelerate from the zero frequency to the set maximum frequency, or to decelerate from the set maximum frequency to zero frequency.

The user can set two different acceleration/deceleration time and set two different ramp s-shape for one application. The active set can be selected with the selected digital input (par. 5.11).

4.7 FLUX BRAKING

Instead of DC braking, flux braking is a useful form of braking with motors of max. 15 kW.

When braking is needed, the frequency is reduced and the flux in the motor is increased, which in turn increases the motor's capability to brake. Unlike DC braking, the motor speed remains controlled during braking.

- 0 = Off
- 1 = Deceleration
- 2 = Chopper
- 3 = Full Mode

Note: Flux braking converts the energy into heat at the motor, and should be used intermittently to avoid motor damage.

4.10 STOP DC CURRENT TIME

Determines if braking is ON or OFF and the braking time of the DC-brake when the motor is stopping. The function of the DC-brake depends on the stop function, par. 2.3.

- 0 = DC brake is not active
- >0 = DC brake is active and its function depends on the Stop function, (par. 2.3). The DC braking time is determined with this parameter.

Par. 2.3 = 0 (Stop function = Coasting):

After the stop command, the motor coasts to a stop without control from the frequency converter.

With the DC injection, the motor can be electrically stopped in the shortest possible time, without using an optional external braking resistor.

The braking time is scaled by the frequency when the DC-braking starts. If the frequency is greater, or equal to the nominal frequency of the motor, the set value of parameter 4.10 determines the braking time. When the frequency is 10% of the nominal, the braking time is 10% of the set value of parameter 4.10.

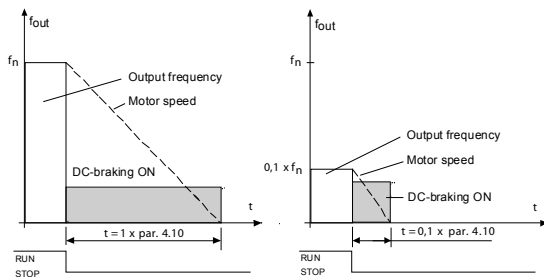

Figure 9.8: DC-braking time when Stop mode = Coasting

Par. 2.3 = 1 (Stop function = Ramp):

After the Stop command, the speed of the motor is reduced according to the set deceleration parameters, if the inertia of the motor and load allows that, to the speed defined with parameter 4.11, where the DC-braking starts.

The braking time is defined with parameter 4.10. See Figure 9.9.

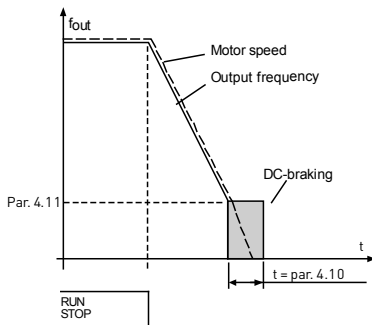

Figure 9.9: DC-braking time when Stop mode = Ramp

4.11 STOP DC CURRENT FREQUENCY

It is the output frequency at which the DC-braking is applied.

4.12 START DC CURRENT TIME

DC-brake is activated when the start command is given. This parameter defines the time of the DC-braking. After the brake is released, the output frequency increases according to the set start function by par. 2.2.

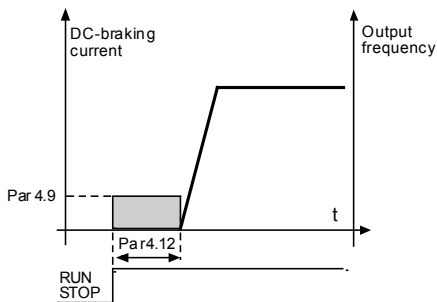

Figure 9.10: DC braking time at start

9.5 Digital inputs (Control panel: Menu PAR -> P5)

These parameters are programmed using the FTT-method (Function To Terminal), where you have a fixed input or output that you define a certain function for. You can also define more than one function to a digital input, e.g. Start signal 1 and Preset Speed B1 to DI1.

The selections for these parameters are:

- 0 = Not used
- 1 = DI1
- 2 = DI2
- 3 = DI3
- 4 = DI4
- 5 = DI5
- 6 = DI6

5.1 I / O CTRL SIGNAL 1

5.2 I / O CTRL SIGNAL 2

5.3 REVERSE

The digital input only active when P2.4 (I/O Start stop logic) =1

The motor will run in reverse when the rising edge of P5.3 is happened.

5.4 EXTERNAL FAULT CLOSE

5.5 EXTERNAL FAULT OPEN

5.6 FAULT RESET

5.7 RUN ENABLE

5.8 PRESET SPEED B0

5.9 PRESET SPEED B1

5.10 PRESET SPEED B2

5.11 RAMP TIME 2 SELECTION

Contact open: Acceleration / Deceleration time 1 and Ramp S-shape selected

Contact closed: Acceleration / Deceleration time 2 and Ramp S-shape2 selected

Set Acceleration / Deceleration times with parameters 4.2 and 4.3 and the alternative ramp times with 4.4 and 4.5.

Set Ramp S-shape with Par. 4.1 and the alternative Ramp S-shape2 with Par. 4.4.

9.6 Analogue inputs (Control panel: Menu PAR -> P6)

6.4 AI1 FILTER TIME

6.8 AI2 FILTER TIME

This parameter, given a value greater than 0, activates the function that filters out disturbances from the incoming analogue signal.

Long filtering time makes the regulation response slower. See Figure 9.11.

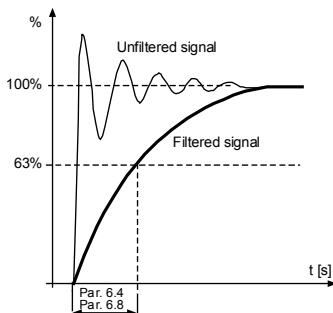

Figure 9.11: AI1 and AI2 signal filtering

6.2 AI1 CUSTOM MINIMUM

6.3 AI1 CUSTOM MAXIMUM

6.6 AI2 CUSTOM MINIMUM

6.7 AI2 CUSTOM MAXIMUM

These parameters set the analogue input signal for any input signal span from -100 to 100%.

9.7 Digital outputs (Control panel: Menu PAR -> P8)

8.1 RO1 SIGNAL SELECTION**8.2 RO2 SIGNAL SELECTION****8.3 DO1 SIGNAL SELECTION**

Setting	Signal content
0 = Not used	Output is not in operation.
1 = Ready	The frequency converter is ready to operate.
2 = Run	The frequency converter operates (motor is running).
3 = Fault	A fault trip has occurred.
4 = Fault inverted	A fault trip has not occurred.
5 = Warning	A warning is active.
6 = Reversed	The reverse command has been selected, output frequency to the motor is negative.
7 = At speed	The output frequency has reached the set reference.
8 = Motor regulator active	Each of motoring current regulator, generating current reg., over voltage reg., under voltage reg. is active.
9 = FB Control Word.B13	Output can be controlled with B13 in the fieldbus control word.
10 = FB Control Word.B14	Output can be controlled with B14 in the fieldbus control word.
11 = FB Control Word.B15	Output can be controlled with B15 in the fieldbus control word.

Table 9.2: Output signals via RO1, RO2 and DO1

9.8 Analogue outputs (Control panel: Menu PAR -> P9)**9.1 ANALOG OUTPUT SIGNAL SELECTION**

0 = Not used

1 = Output frequency (0 - f_{max})

2 = Output current (0 - I_{nMotor})

3 = Motor torque (0 - T_{nMotor})

4 = PID output (0 - 100%)

9.2 ANALOG OUTPUT MINIMUM

0 = 0 mA

1 = 4 mA

9.9 Protections (Control panel:Menu Par->P13)

13.5 STALL PROTECTION

- 0 = No action
- 1 = Alarm
- 2 = Fault, coast

The motor stall protection protects the motor from short time overload situations such as one caused by a stalled shaft. The stall current is $I_{nMotor} * 1.3$, stall time 15 seconds and stall frequency limit 25 Hz. If the current is higher than the limit and output frequency is lower than the limit, the stall state is true and the drive reacts according to this parameter. There is actually no real indication of the shaft rotation.

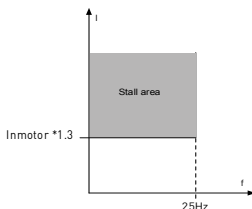

Figure 9.12: Stall characteristics

13.6 UNDER LOAD PROTECTION

- 0 = No action
- 1 = Alarm
- 2 = Fault, coast

The purpose of the motor underload protection is to ensure that there is load on the motor when the drive is running. If the motor loses its load there might be a problem in the process, e.g. a broken belt or a dry pump.

The underload protection time limit is 20 seconds, which is the maximum time allowed for an underload state to exist before causing a trip according to this parameter.

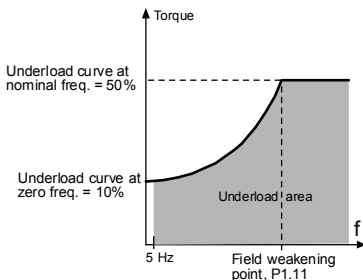

Figure 9.13: Underload protection

13.7 MOTOR THERMAL PROTECTION

- 0 = No action
- 1 = Alarm
- 2 = Fault, coast

If tripping is selected the drive will stop and activate the fault stage, if the temperature of the motor becomes too high. Deactivating the protection, i.e. setting parameter to 0, will reset the thermal model of the motor to 0%.

The motor thermal protection is to protect the motor from overheating. The drive is capable of supplying higher than nominal current to the motor. If the load requires this high current there is a risk that the motor will be thermally overloaded. This is the case especially at low frequencies. At low frequencies the cooling effect of the motor is reduced as well as its capacity. If the motor is equipped with an external fan the load reduction at low speeds is small.

The motor thermal protection is based on a calculated model and it uses the output current of the drive to determine the load on the motor.

The motor thermal protection can be adjusted with parameters. The thermal current I_T specifies the load current above which the motor is overloaded. This current limit is a function of the output frequency.

CAUTION! The calculated model does not protect the motor if the airflow to the motor is reduced by blocked air intake grill.

NOTE! To comply with UL 508C requirements motor over-temperature sensing is required at installation if the parameter is set to 0.

13.8 MTP:AMBIENT TEMPERATURE

When the motor ambient temperature must be taken into consideration, it is recommended to set a value for this parameter. The value can be set between -20 and 100 degrees Celsius.

13.9 MTP:ZERO SPEED COOLING

The cooling power can be set between 0 - 150.0% x cooling power at nominal frequency. See Figure 9.14.

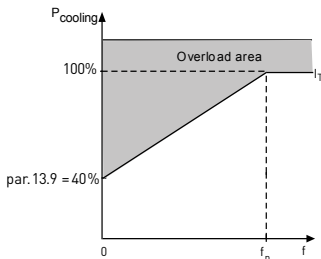

Figure 9.14: Motor cooling power

13.10 MTP:THERMAL TIME CONSTANT

This time can be set between 1 and 200 minutes.

This is the thermal time constant of the motor. The bigger the motor, the longer the time constants. The time constant is the time within which the calculated thermal model has reached 63% of its final value.

The motor thermal time is specific to the motor design and it varies between different motor manufacturers.

If the motor's t_6 -time (t_6 is the time in seconds the motor can safely operate at six times the rated current) is known (given by the motor manufacturer) the time constant parameter can be set basing on it. As a rule of thumb, the motor thermal time constant in minutes equals to $2 \times t_6$. If the drive is in stop state the time constant is internally increased to three times the set parameter value. See also Figure 9.15.

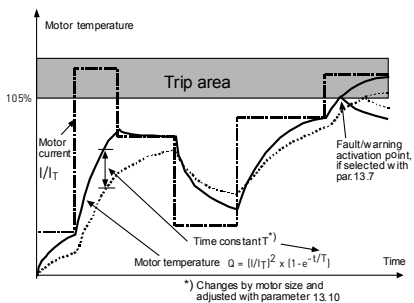

Figure 9.15: Motor temperature calculation

9.11 PI control parameters (Control panel: Menu PAR -> P15)

15.7 P GAIN

This parameter defines the gain of the PI controller. If the value of the parameter is set to 100%, a change of 10% in the error value causes the controller output to change by 10%.

15.8 I-TIME

This parameter defines the integration time of the PI controller. If this parameter is set to 1,00 second, the controller output is changed by a value corresponding to the output caused from the gain every second. $(\text{Gain} \cdot \text{Error}) / s$.

15.9 PID CONTROLLER D-TIME

This parameter defines the derivative time of the PID controller. If this parameter is set to 1,00 second, a change of 10% in the error value causes the controller output to change by 10%.

15.5 FEEDBACK VALUE MINIMUM

15.6 FEEDBACK VALUE MAXIMUM

This parameter sets the minimum and maximum scaling points for feedback value.

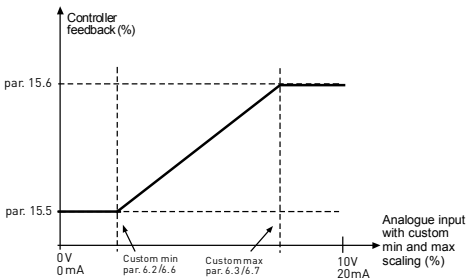

Figure 9.17: Feedback minimum and maximum

9.12 Application setting (Control panel: Menu PAR->P17)

17.1 DRIVE SETUP

With this parameter you can easily set up your drive for four different applications.

Note! This parameter is only visible when the Startup Wizard is active. The startup wizard will start in first power-up. It can also be started as follows. See the figures below.

NOTE! Running the startup wizard will always return all parameter settings to their factory defaults!

NOTE! StartUp-Wizard can be skipped after pressing STOP button continuously for 30 seconds

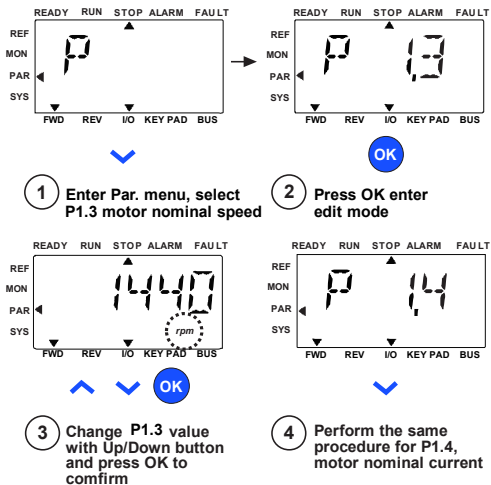
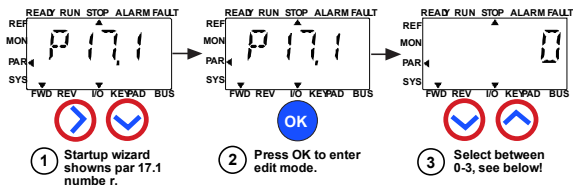

Figure 9.18: Startup wizard



Selections:

	P1.7	P1.8	P1.15	P2.2	P2.3	P3.1	P4.2	P4.3
0 = Basic	1.5 x InMOT	0= Frequency control	0= Not used	0= Ramp	0= Coast	0 Hz	3s	3s
1 = Pump drive	1.1 x InMOT	0= Frequency control	0= Not used	0= Ramp	1= Ramp	20 Hz	5s	5s
2 = Fan drive	1.1 x InMOT	0= Frequency control	0= Not used	1= Flying	0= Coast	20 Hz	20s	20s
3 = High Torque drive	1.5 x InMOT	1= Open loop speed control	1= used	0= Ramp	0= Coast	0 Hz	1s	1s

Parameters affected:

P1.7 Current limit (A)	P2.3 Stop function
P1.8 Motor control mode	P3.1 Min frequency
P1.15 Torque boost	P4.2 Acc. time (s)
P2.2 Start function	P4.3 Dec time (s)

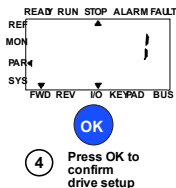

Figure 9.19: Drive setup

9.13 Modbus RTU

Vacon 10 has a built-in Modbus RTU bus interface. The signal level of the interface is in accordance with the RS-485 standard.

The built-in Modbus connection of Vacon 10 supports the following function codes:

Function code	Function name	Address	Broadcast messages
03	Read Holding Registers	All ID numbers	No
04	Read Input Registers	All ID numbers	No
06	Write Single Registers	All ID numbers	Yes
16	Write multiple registers	All ID numbers	Yes

Table 9.3: Modbus RTU

9.13.1 Termination resistor

The RS-485 bus is terminated with termination resistors of 120 ohms in both ends. Vacon 10 has a built-in termination resistor which is switched off as a default (presented below). The termination resistor can be switched on and off with the right hand dip switch located above IO-terminals in the front of the drive (see below).

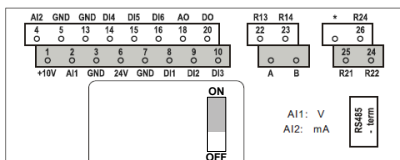

Figure 9.20: Vacon 10 I/O

9.13.2 Modbus address area

The Modbus interface of Vacon 10 uses the ID numbers of the application parameters as addresses. The ID numbers can be found in the parameter tables in chapter 8. When several parameters / monitoring values are read at a time, they must be consecutive. 11 addresses can be read and the addresses can be parameters or monitoring values.

Note! With some PLC manufacturers, the interface driver for Modbus RTU communication may contain an offset of 1 (the ID number to be used would then subtract 1).

9.13.3 Modbus process data

Process data is an address area for fieldbus control. Fieldbus control is active when the value of parameter 2.1 [Control place] is 3 (= fieldbus). The content of the process data has been determined in the application. The following tables present the process data contents in the General Purpose Application.

ID	Modbus register	Name	Scale	Type
2101	32101, 42101	FB Status Word	-	Binary coded
2102	32102, 42102	FB General Status Word	-	Binary coded
2103	32103, 42103	Reserved	0,01	%
2104	32104, 42104	Output frequency	0.01	+/- Hz
2105	32105, 42105	Motor speed	1	+/- Rpm
2106	32106, 42106	Motor current	0.01	A
2107	32107, 42107	Motor torque	0,1	+/- % [of nominal]
2108	32108, 42108	Motor power	0,1	+/- % [of nominal]
2109	32109, 42109	Motor voltage	0,1	V
2110	32110, 42110	DC link voltage	1	V
2111	32111, 42111	Active fault code	1	-

Table 9.4: Output process data

ID	Modbus register	Name	Scale	Type
2001	32001, 42001	FB Control Word	-	Binary coded
2002	32002, 42002	FB General Control Word	-	Binary coded
2003	32003, 42003	Reserved	0,01	%
2004	32004, 42004	Programmable by P15.1		
2005	32005, 42005	Programmable by P15.4		
2006	32006, 42006	-	-	-
2007	32007, 42007	-	-	-
2008	32008, 42008	-	-	-
2009	32009, 42009	-	-	-
2010	32010, 42010	-	-	-
2011	32011, 42011	-	-	-

Table 9.5: Input process data

Note! 2004 can set as PI Control Reference by setting P15.1[Setpoint selection] or 2005 can be set as PI Actual value by setting P15.4 [Feedback value selection]!

Status word (output process data)

Information about the status of the device and messages is indicated in the Status word. The Status word is composed of 16 bits the meanings of which are described in the table below:

Bit	Description	
	Value = 0	Value = 1
B0, RDY	Drive not ready	Drive ready
B1, RUN	Stop	Run
B2, DIR	Clockwise	Counter-clockwise
B3, FLT	No fault	Fault active
B4, W	No alarm	Alarm active
B5, AREF	Ramping	Speed reference reached
B6, Z	-	Drive is running at zero speed
B7 - B15	-	-

Table 9.6: Status word (output process data)

Actual speed (output process data)

This is actual speed of the frequency converter. The scaling is -10000...10000. The value is scaled in percentage of the frequency area between set minimum and maximum frequency.

Control word (input process data)

The three first bits of the control word are used to control the frequency converter. By using control word it is possible to control the operation of the drive. The meanings of the bits of control word are explained in the table below:

Bit	Description	
	Value = 0	Value = 1
B0, RUN	Stop	Run
B1, DIR	Clockwise	Counter-clockwise
B2, RST	Rising edge of this bit will reset active fault	

Table 9.7: Control word (input process data)

Speed reference (input process data)

This is the Reference 1 to the frequency converter. Used normally as Speed reference. The allowed scaling is 0...10000. The value is scaled in percentage of the frequency area between the set minimum and maximum frequencies.

10. TECHNICAL DATA

10.1 Vacon 10 technical data

Mains connection	Input voltage U_{in}	115 V, -15%...+10% 1- 208...240 V, -15%...+10% 1- 208...240 V, -15%...+10% 3- 380 - 480 V, -15%...+10% 3- 600 V, -15%...+10% 3-
	Input frequency	45...66 Hz
	Connection to mains	Once per minute or less (normal case)
Supply network	Networks	Vacon 10 (400 V) cannot be used with corner grounded networks
	Short circuit current	Maximum short circuit current has to be < 50 kA.
Motor connection	Output voltage	0 - U_{in}
	Output current	Continuous rated current I_N at ambient temperature max. +50 °C (depends on the unit size), overload 1.5 x I_N max. 1 min / 10 min
	Starting current / torque	Current 2 x I_N for 2 sec in every 20 sec period. Torque depends on motor
	Output frequency	0...320 Hz
	Frequency resolution	0,01 Hz
Control connection	Digital input	Positive; Logic 1: 8...+30V; Logic 0: 0...1.5V, $R_i = 20K\Omega$
	Analogue input voltage	0...+10V, $R_i = 300 K\Omega$ (min)
	Analogue input current	0(4)...20mA, $R_i = 200\Omega$
	Analogue output	0(4)...20mA, $R_L = 500\Omega$
	Digital output	Open collector, max. load 35V/50mA
	Relay output	Switching load: 250Vac/3A, 24V DC 3A
Auxiliary voltage	±20%, max. load 50mA	
Control characteristics	Control method	Frequency Control U / f Open Loop Sensorless Vector Control
	Switching frequency	1...16 kHz; Factory default 4 kHz
	Frequency reference	Resolution 0.01 Hz
	Field weakening point	30...320 Hz
	Acceleration time	0.1...3000 sec
	Deceleration time	0.1...3000 sec
	Braking torque	100%* T_N with brake option (only in 3- drives sizes MI2-5) 30%* T_N without brake option

Table 10.1: Vacon 10 technical data

Ambient conditions	Ambient operating temperature	-10 °C (no frost)...+40 / 50°C (depends on the unit size): rated loadability I_N Side by side installation for MI1-3 it is always 40°C; For IP21/Nema1 option in MI1-3 the maximum temperature is also 40 °C.
	Storage temperature	-40°C...+70°C
	Relative humidity	0...95% RH, non-condensing, non-corrosive, no dripping water
	Air quality: - chemical vapours - mech. particles	IEC 721-3-3, unit in operation, class 3C2 IEC 721-3-3, unit in operation, class 3S2
	Altitude	100% load capacity (no derating) up to 1000 m. 1% derating for each 100 m above 1000 m; max. 2000 m
	Vibration: EN60068-2-6	3...150 Hz Displacement amplitude 1[peak] mm at 3...15.8 Hz Max acceleration amplitude 1 G at 15.8...150 Hz
	Shock IEC 68-2-27	UPS Drop Test (for applicable UPS weights) Storage and shipping: max 15 G, 11 ms (in package)
	Enclosure class	IP20 / IP21 / Nema1 for MI1-3
	Pollution degree	PD2
EMC	Immunity	Complies with EN50082-1, -2, EN61800-3
	Emissions	230V: Complies with EMC category C2; With an internal RFI filter 400V: Complies with EMC category C2; With an internal RFI filter Both: No EMC emission protection (Vacon level N): Without RFI filter
Standards		For EMC: EN61800-3 For safety: UL508C, EN61800-5
Certificates and manufacturer's declarations of conformity		For safety: CE, UL, cUL, KC For EMC: CE, KC (see unit nameplate for more detailed approvals)

Table 10.1: Vacon 10 technical data

10.2 Power ratings

10.2.1 Vacon 10 – Mains voltage 208-240 V

Mains voltage 208-240 V, 50/60 Hz, 1~ series								
Freq. converter type	Rated loadability		Motor shaft power		Nominal input current	Mechanical size	Weight (kg)	
	100% contin. current I_N [A]	150% over-load current [A]	P [HP]	P [KW]	[A]			
0001	1.7	2.6	0.33	0.25	4.2	M11	0.55	
0002	2.4	3.6	0.5	0.37	5.7	M11	0.55	
0003	2.8	4.2	0.75	0.55	6.6	M11	0.55	
0004	3.7	5.6	1	0.75	8.3	M12	0.7	
0005	4.8	7.2	1.5	1.1	11.2	M12	0.7	
0007	7	10.5	2	1.5	14.1	M12	0.7	
0009*	9.6	14.4	3	2.2	22.1	M13	0.99	

Table 10.2: Vacon 10 power ratings, 208-240 V

* The maximum ambient operating temperature of this drive is 40 °C!

Mains voltage 208 - 240 V, 50/60 Hz, 3~ series								
Freq. converter type	Rated loadability		Motor shaft power		Nominal input current	Mechanical size	Weight (kg)	
	100% contin. current I_N [A]	150% over-load current [A]	P [HP]	P [KW]	[A]			
0001	1.7	2.6	0.33	0.25	2.7	M11	0.55	
0002	2.4	3.6	0.5	0.37	3.5	M11	0.55	
0003	2.8	4.2	0.75	0.55	3.8	M11	0.55	
0004	3.7	5.6	1	0.75	4.3	M12	0.7	
0005	4.8	7.2	1.5	1.1	6.8	M12	0.7	
0007*	7	10.5	2	1.5	8.4	M12	0.7	
0011*	11	16.5	3	2.2	13.4	M13	0.99	

Table 10.3: Vacon 10 power ratings, 208-240 V, 3~

* The maximum ambient operating temperature of these drives is +40 °C.

10.2.2 Vacon 10 – Mains voltage 115 V

Mains voltage 115 V, 50/60 Hz, 1~ series							
Freq. converter type	Rated loadability		Motor shaft power		Nominal input current	Mechanical size	Weight [Kg]
	100% contin. current I_N [A]	150% over-load current [A]	P [HP]	P [KW]	[A]		
0001	1.7	2.6	0.33	0.25	9.2	MI2	0.7
0002	2.4	3.6	0.5	0.37	11.6	MI2	0.7
0003	2.8	4.2	0.75	0.55	12.4	MI2	0.7
0004	3.7	5.6	1	0.75	15	MI2	0.7
0005	4.8	7.2	1.5	1.1	16.5	MI3	0.99

Table 10.4: Vacon 10 power ratings, 115 V, 1~

10.2.3 Vacon 10 – Mains voltage 380-480 V

Mains voltage 380-480 V, 50/60 Hz, 3~ series							
Freq. converter type	Rated loadability		Motor shaft power		Nominal input current	Mechanical size	Weight (kg)
	100% contin. current I_N [A]	150% over-load current [A]	P [HP]	P [KW]	[A]		
0001	1.3	2	0.5	0.37	2.2	MI1	0.55
0002	1.9	2.9	0.75	0.55	2.8	MI1	0.55
0003	2.4	3.6	1	0.75	3.2	MI1	0.55
0004	3.3	5	1.5	1.1	4	MI2	0.7
0005	4.3	6.5	2	1.5	5.6	MI2	0.7
0006	5.6	8.4	3	2.2	7.3	MI2	0.7
0008	7.6	11.4	4	3	9.6	MI3	0.99
0009	9	13.5	5	4	11.5	MI3	0.99
0012	12	18	7.5	5.5	14.,9	MI3	0.99

Table 10.5: Vacon 10 power ratings, 380-480 V

10.2.4 Vacon 10 – Mains voltage 600 V

Mains voltage 600 V, 50/60 Hz, 3~ series							
Freq. converter type	Rated loadability		Motor shaft power		Nominal input current [A]	Mechanical size	Weight (kg)
	100% contin. current I_N [A]	150% over-load current [A]	P [HP]	P [KW]			
0002	1,7	2,6	1	0,75	2	MI3	0,99
0003	2,7	4,2	2	1,5	3,6	MI3	0,99
0004	3,9	5,9	3	2,2	5	MI3	0,99
0006	6,1	9,2	5	3,7	7,6	MI3	0,99
0009	9	13,5	7,5	5,5	10,4	MI3	0,99

Table 10.6: Vacon 10 power ratings, 600 V

Note 1: The input currents are calculated values with 100 kVA line transformer supply.

Note 2: The mechanical dimensions of the units are given in Chapter 3.1.1.

10.3 Brake resistors

Vacon 10 type	Minimum braking resistance	Resistor type code (from Vacon NX family)		
		Light duty	Heavy duty	Resistance
MI2 204-240V, 3~	50 Ohm	-	-	-
MI2 380-480V, 3~	118 Ohm	-	-	-
MI3 204-240V, 3~	31 Ohm	-	-	-
MI3 380-480V, 3~	55 Ohm	BRR-0022-LD-5	BRR-0022-HD-5	63 Ohm
MI3 600V, 3~	100 Ohm	BRR-0013-LD-6	BRR-0013-HD-6	100 Ohm

Note! For MI2 and MI3, only 3-phase units are equipped with brake chopper.

For further information on brake resistors, please download Vacon NX Brake Resistor Manual (UD00971C) on [http://www.vacon.com / Support & Downloads](http://www.vacon.com/Support%20&%20Downloads)

VACON®

DRIVEN BY DRIVES

Find your nearest Vacon office
on the Internet at:

www.vacon.com

Manual authoring:
documentation@vacon.com

Vacon Plc.
Runsorintie 7
65380 Vaasa
Finland

Subject to change without prior notice
© 2012 Vacon Plc.

Document ID:



Rev. F1