

VACON[®] 20
AC DRIVES

COMPLETE USER MANUAL

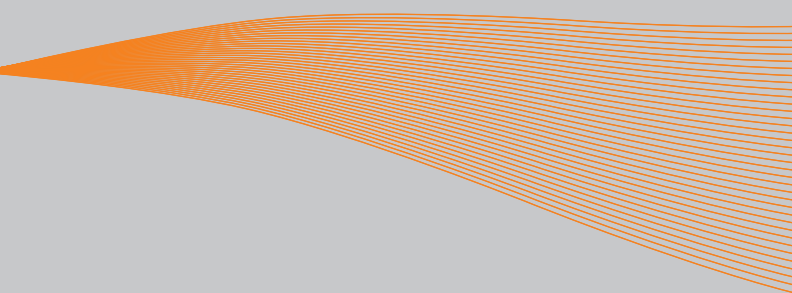

1.Safety	1
1.1Warnings	1
1.2Safety instructions	3
1.3Earthing and earth fault protection	3
1.4Before running the motor	5
2.Receipt of delivery	6
2.1Type designation code	6
2.2Storage	6
2.3Maintenance	7
2.3.1Capacitor recharge	7
2.4Warranty	8
2.5Manufacturer's declaration of conformity	9
3.Installation	10
3.1Mechanical installation	10
3.1.1Vacon 20 dimensions	14
3.1.2Cooling	18
3.1.3Power losses	19
3.1.4EMC levels	26
3.1.5Changing the EMC protection class from C2 to C4	27
3.2Cabling and connections	29
3.2.1Power cabling	29
3.2.2Control cabling	31
3.2.3Allowed option boards in Vacon20	35
3.2.4Screw of cables	38
3.2.5Cable and fuse specifications	40
3.2.6General cabling rules	43
3.2.7Stripping lengths of motor and mains cables	44
3.2.8Cable installation and the UL standards	44
3.2.9Cable and motor insulation checks	44
4.Commissioning	46
4.1Commissioning steps of Vacon 20	46
5.Fault tracing	48
6.Vacon 20 Application Interface	54
6.1Introduction	54
6.2Control I / O	56
7.Control panel	58
7.1General	58
7.2Display	58
7.3Keypad	59

7.4	Navigation on the Vacon 20 control panel	61
7.4.1	Main menu	61
7.4.2	Reference menu	62
7.4.3	Monitoring menu	63
7.4.4	Parameter menu	67
7.4.5	System menu	68
8.	STANDARD application parameters	70
8.1	Quick setup parameters (Virtual menu, shows when par. 17.2 = 1)	71
8.2	Motor settings (Control panel: Menu PAR -> P1)	73
8.3	Start / stop setup (Control panel: Menu PAR -> P2)	76
8.4	Frequency references (Control panel: Menu PAR -> P3)	77
8.5	Ramps and brakes setup (Control panel: Menu PAR -> P4)	78
8.6	Digital inputs (Control panel: Menu PAR -> P5)	80
8.7	Analogue inputs (Control panel: Menu PAR -> P6)	81
8.8	Pulse train / Encoder (Control panel: Menu PAR -> P7)	81
8.9	Digital outputs (Control panel: Menu PAR -> P8)	82
8.10	Analogue outputs (Control panel: Menu PAR -> P9)	84
8.11	Fieldbus Data-Mapping (Control panel: Menu PAR -> P10)	85
8.12	Prohibited Frequencies (Control panel: Menu PAR -> P11)	86
8.13	Limit Supervisions (Control panel: Menu PAR -> P12)	87
8.14	Protections (Control panel: Menu PAR -> P13)	88
8.15	Fault autoreset parameters (Control panel: Menu PAR -> P14)	90
8.16	PID control parameters (Control panel: Menu PAR -> P15)	91
8.17	Motor Pre-heat (Control panel: Menu PAR -> P16)	94
8.18	Easy usage menu (Control panel: Menu PAR -> P17)	94
8.19	System parameters	95
9.	Parameter descriptions	101
9.1	Motor settings (Control panel: Menu PAR -> P1)	101
9.2	Start / stop setup (Control panel: Menu PAR -> P2)	107
9.3	Frequency references (Control panel: Menu PAR -> P3)	115
9.4	Ramps & brakes setup (Control panel: Menu PAR -> P4)	117
9.5	Digital inputs (Control panel: Menu PAR -> P5)	122
9.6	Analogue inputs (Control panel: Menu PAR -> P6)	123
9.7	Pulse train / Encoder (Control panel: Menu PAR -> P7)	124
9.8	Digital outputs (Control panel: Menu PAR -> P8)	126
9.9	Analogue outputs (Control panel: Menu PAR -> P9)	127
9.10	Fieldbus Data-Mapping (Control panel: Menu PAR -> P10)	128
9.11	Prohibited Frequencies (Control panel: Menu PAR -> P11)	129
9.12	Protections (Control panel: Menu Par->P13)	130
9.13	Automatic reset (Control panel: Menu PAR -> P14)	137
9.14	PID control parameters (Control panel: Menu PAR -> P15)	138

9.15	Application setting (Control panel: Menu PAR->P17)	141
9.16	System parameter	143
9.17	Modbus RTU	145
9.17.1	Termination resistor	145
9.17.2	Modbus address area	145
9.17.3	Modbus process data	146
10.	Technical data	150
10.1	Vacon 20 technical data	150
10.2	Power ratings	152
10.2.1	Vacon 20 – Mains voltage 208-240 V	152
10.2.2	Vacon 20 – Mains voltage 115 V	153
10.2.3	Vacon 20 – Mains voltage 380-480 V	153
10.2.4	Vacon 20 – Mains voltage 600 V	154
10.3	Brake resistors	154

1. SAFETY



ONLY A COMPETENT ELECTRICIAN IS ALLOWED TO CARRY OUT THE ELECTRICAL INSTALLATION!

This manual contains clearly marked cautions and warnings which are intended for your personal safety and to avoid any unintentional damage to the product or connected appliances.

Please read the information included in cautions and warnings carefully:

	<p>=Dangerous voltage Risk of death or severe injury</p>
	<p>=General warning Risk of damage to the product or connected appliances</p>

1.1 Warnings



The components of the power unit of the frequency converter are live when Vacon 20 is connected to mains. Coming into contact with this voltage is extremely dangerous and may cause death or severe injury. The control unit is isolated from the mains potential.



The motor terminals U, V, W (T1, T2, T3) and the possible brake resistor terminals - / + are live when Vacon 20 is connected to mains, even if the motor is not running.



The control I / O-terminals are isolated from the mains potential. However, the relay output terminals may have a dangerous control voltage present even when Vacon 20 is disconnected from mains.



The earth leakage current of Vacon 20 frequency converters exceeds 3.5 mA AC. According to standard EN61800-5-1, a reinforced protective ground connection must be ensured.



If the frequency converter is used as a part of a machine, the machine manufacturer is responsible for providing the machine with a main switch [EN 60204-1].



If Vacon 20 is disconnected from mains while running the motor, it remains live if the motor is energized by the process. In this case the motor functions as a generator feeding energy to the frequency converter.







After disconnecting the frequency converter from the mains, wait until the fan stops and the indicators on the display go out. Wait 5 more minutes before doing any work on Vacon 20 connections.



The motor can start automatically after a fault situation, if the autoreset function has been activated.

1.2 Safety instructions

-  The Vacon 20 frequency converter has been designed for fixed installations only.
-  Do not perform any measurements when the frequency converter is connected to the mains.
-  Do not perform any voltage withstand tests on any part of Vacon 20. The product safety is fully tested at factory.
-  Prior to measurements on the motor or the motor cable, disconnect the motor cable from the frequency converter.
-  Do not open the cover of Vacon 20. Static voltage discharge from your fingers may damage the components. Opening the cover may also damage the device. If the cover of Vacon 20 is opened, warranty becomes void.

1.3 Earthing and earth fault protection

The Vacon 20 frequency converter **must always** be earthed with an earthing conductor connected to the earthing terminal. See figure below:

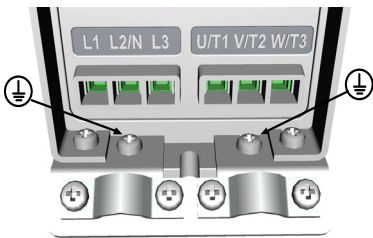

MI1 - MI3



MI4

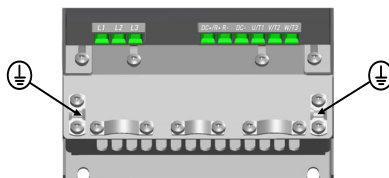

MI5

- The earth fault protection inside the frequency converter protects only the converter itself against earth faults.
- If fault current protective switches are used they must be tested with the drive with earth fault currents that are possible to arise in fault situations.

1.4 Before running the motor

Checklist:



Before starting the motor, check that the motor is mounted properly and ensure that the machine connected to the motor allows the motor to be started.



Set the maximum motor speed (frequency) according to the motor and the machine connected to it.



Before reversing the motor shaft rotation direction make sure that this can be done safely.



Make sure that no power correction capacitors are connected to the motor cable.

NOTE! You can download the English and French product manuals with applicable safety, warning and caution information from www.vacon.com/downloads.

REMARQUE Vous pouvez télécharger les versions anglaise et française des manuels produit contenant l'ensemble des informations de sécurité, avertissements et mises en garde applicables sur le site www.vacon.com/downloads.

2. RECEIPT OF DELIVERY

After unpacking the product, check that no signs of transport damages are to be found on the product and that the delivery is complete (compare the type designation of the product to the code below).

Should the drive have been damaged during the shipping, please contact primarily the cargo insurance company or the carrier.

If the delivery does not correspond to your order, contact the supplier immediately.

2.1 Type designation code

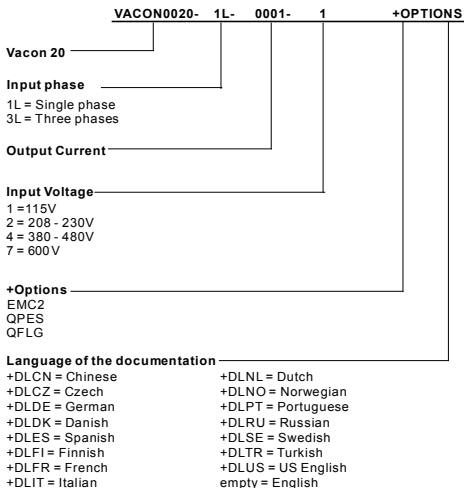

Figure 2.1: Vacon 20 type designation code

2.2 Storage

If the frequency converter is to be kept in store before use make sure that the ambient conditions are acceptable:

Storing temperature -40...+70 °C

Relative humidity < 95%, no condensation

2.3 Maintenance

In normal operating conditions, Vacon 20 frequency converters are maintenance-free. However, regular maintenance is recommended to ensure a trouble-free operating and a long lifetime of the drive. We recommended to follow the table below for maintenance intervals.

Maintenance interval	Maintenance action
Whenever necessary	<ul style="list-style-type: none"> Clean headsink*
Regular	<ul style="list-style-type: none"> Check tightening torques of terminals
12 months (If stored)	<ul style="list-style-type: none"> Check input and output terminals and control I / O terminals. Clean cooling tunnel.* Check operation of cooling fan, check for corrosion on terminals, busbars and other surfaces.*
6 - 24 months (depending on environment)	<ul style="list-style-type: none"> Check and clean and clean cooling fans: Main fan* Interminal fan*

* Only for frame 4 and frame 5

2.3.1 Capacitor recharge

After a longer storage time the capacitors need to be recharge in order to avoid capacitor damage. Possible high leakage current through the capacitors must be limited. The best way to achieve this is to use a DC-power supply with adjustable current limit.

- 1) Set the current limit to 300...800 mA according to the size of the drive.
- 2) Then connect the DC-power supply to the input phase L1 and L2.
- 3) Then set the DC-voltage to the nominal DC-voltage level of the (1.35*Un AC) and supply the converter for at least 1 h.

If DC-voltage is not available and the unit has been stored much longer than 12 months deenergized, consult the factory before connecting power.

2.4 Warranty

Only manufacturing defects are covered by the warranty. The manufacturer assumes no responsibility for damages caused during or resulting from transport, receipt of the delivery, installation, commissioning or use.

The manufacturer shall in no event and under no circumstances be held responsible for damages and failures resulting from misuse, wrong installation, unacceptable ambient temperature, dust, corrosive substances or operation outside the rated specifications. Neither can the manufacturer be held responsible for consequential damages.

The Manufacturer's time of warranty is 18 months from the delivery or 12 months from the commissioning whichever expires first (Vacon Warranty Terms).

The local distributor may grant a warranty time different from the above. This warranty time shall be specified in the distributor's sales and warranty terms. Vacon assumes no responsibility for any other warranties than that granted by Vacon itself.

In all matters concerning the warranty, please contact first your distributor.

2.5 Manufacturer's declaration of conformity

**EC DECLARATION OF CONFORMITY**

We

Manufacturer's name: Vacon Oyj
Manufacturer's address: P.O.Box 25
Runsorintie 7
FIN-65381 Vaasa
Finland

hereby declare that the product

Product name: Vacon 20 Frequency Converter
Model designation: Vacon 20 1L 0001 2...to 0009 2
Vacon 20 3L 0001 2...to 0038 2
Vacon 20 3L 0001 4...to 0038 4

has been designed and manufactured in accordance with the following standards:

Safety: EN 60204 -1:2009 (as relevant),
EN 61800-5-1:2007
EMC: EN 61800-3:2004+A1:2012

and conforms to the relevant safety provisions of the Low Voltage Directive 2006/95/EC and EMC Directive 2004/108/EC.

It is ensured through internal measures and quality control that the product conforms at all times to the requirements of the current Directive and the relevant standards.

In Vaasa, 16th of April, 2014

Vesa Laisi
President

The year the CE marking was affixed: 2011

3. INSTALLATION

3.1 Mechanical installation

There are two possible ways to mount Vacon 20 in the wall. For MI1-MI3, either screw or DIN-rail mounting; For MI4-MI5, screw or flange mounting.

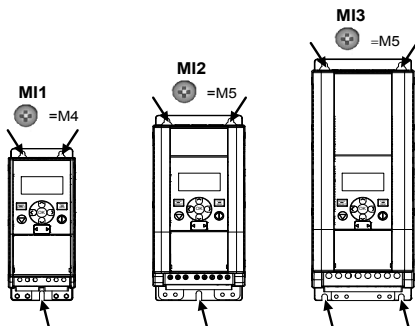

Figure 3.1: Screw mounting, MI1 - MI3

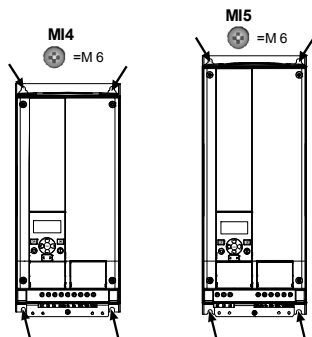

Figure 3.2: Screw mounting, MI4 - MI5

Note! See the mounting dimensions on the back of the drive. More details in Chapter 3.1.1.

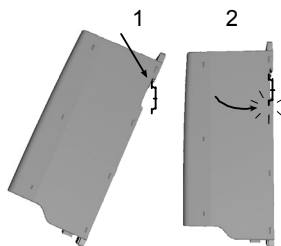

Figure 3.3: DIN-rail mounting, MI1 - MI3

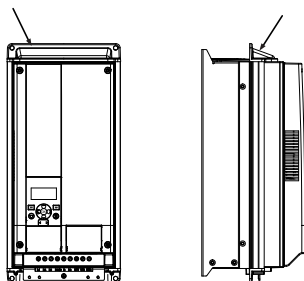

Figure 3.4: Flange mounting, MI4 - MI5

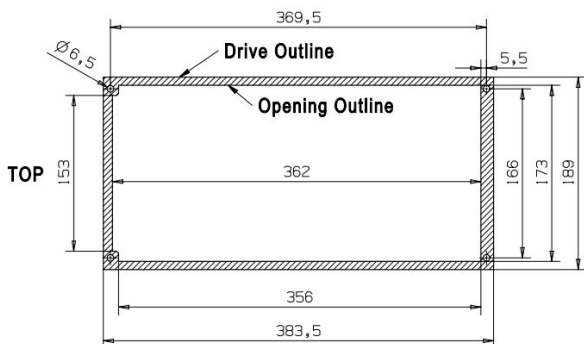

Figure 3.5: Flange mounting cutout dimensions for MI4 (Unit: mm)

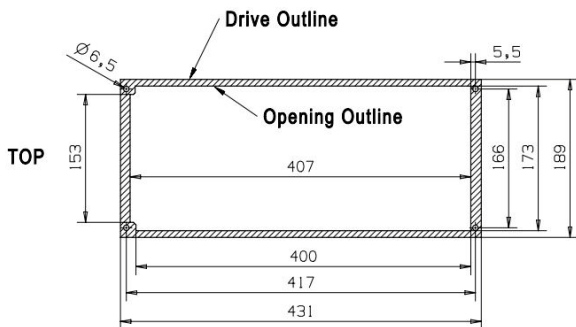

Figure 3.6: Flange mounting cutout dimensions for MI5 (Unit: mm)

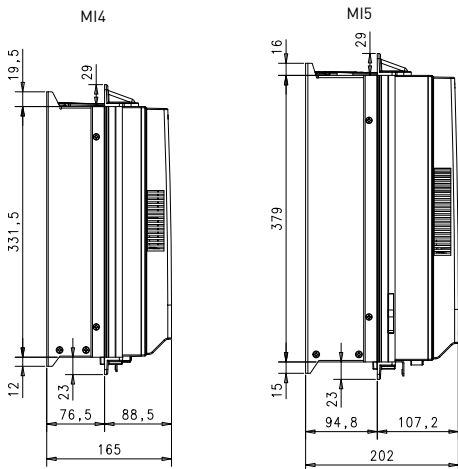

Figure 3.7: Flange mounting depth dimensions for MI4 and MI5 (Unit: mm)

3.1.1 Vacon 20 dimensions

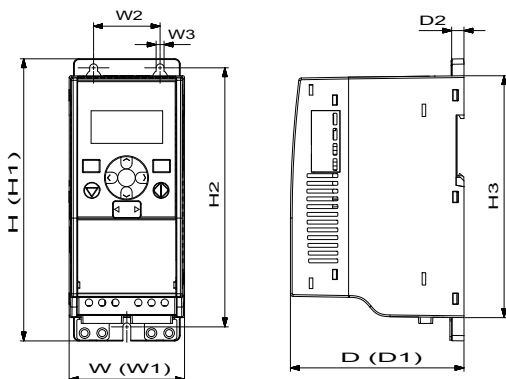

Figure 3.8: Vacon 20 dimensions, MI1 - MI3

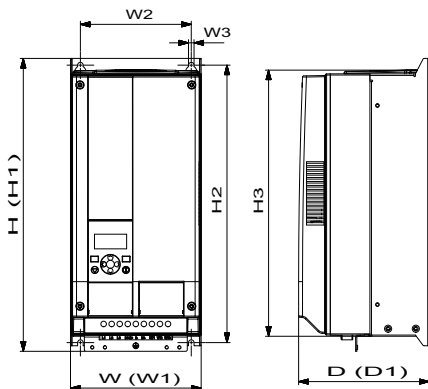

Figure 3.9: Vacon 20 dimensions, MI4 - MI5

Type	H1	H2	H3	W1	W2	W3	D1	D2
MI1	160.1	147	137.3	65.5	37.8	4.5	98.5	7
MI2	195	183	170	90	62.5	5.5	101.5	7
MI3	254.3	244	229.3	100	75	5.5	108.5	7
MI4	370	350.5	336.5	165	140	7	165	-
MI5	414	398	383	165	140	7	202	-

Table 3.1: Vacon 20 dimensions in millimetres

Frame	Dimensions(mm)			Weight*
	W	H	D	(kg.)
MI1	66	160	98	0.5
MI2	90	195	102	0.7
MI3	100	254.3	109	1
MI4	165	370	165	8
MI5	165	414	202	10
				*without shipping package

Table 3.2: Vacon 20 frame dimensions (mm) and weights (kg)

Frame	Dimensions(Inches)			Weight*
	W	H	D	(lbs.)
MI1	2.6	6.3	3.9	1.2
MI2	3.5	9.9	4	1.5
MI3	3.9	10	4.3	2.2
MI4	6.5	14.6	6.5	18
MI5	6.5	16.3	8	22
				*without shipping package

Table 3.3: Vacon 20 frame dimensions (Inch) and weights (lbs)

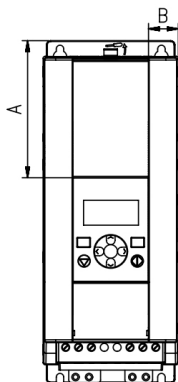

Figure 3.10: Vacon20 dimensions, MI2 - 3 Display Location

Dimensions (mm)	Frame	
	MI2	MI3
A	17	22.3
B	44	102

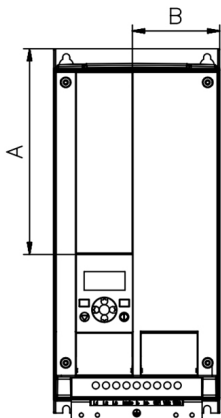

Figure 3.11: Vacon20 dimensions, MI4 - 5 Display Location

Dimensions (mm)	Frame	
	MI2	MI3
A	205	248.5
B	87	87

3.1.2 Cooling

Enough free space shall be left above and below the frequency converter to ensure sufficient air circulation and cooling. You will find the required dimensions for free space in the table below.

If several units are mounted above each other the required free space equals C + D (see figure below). Moreover, the outlet air used for cooling by the lower unit must be directed away from the air intake of the upper unit.

The amount of cooling air required is indicated below. Also make sure that the temperature of the cooling air does not exceed the maximum ambient temperature of the converter.

Min clearance (mm)				
Type	A*	B*	C	D
MI1	20	20	100	50
MI2	20	20	100	50
MI3	20	20	100	50
MI4	20	20	100	100
MI5	20	20	120	100

Table 3.4: Min. clearances around AC drive

*. Min clearance A and B for drives for MI1 - MI3 can be 0 mm if the ambient temperature is below 40 degrees.

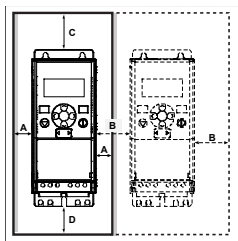

Figure 3.12: Installation space

A = clearance around the freq. converter (see also B)

B = distance from one frequency converter to another or distance to cabinet wall

C = free space above the frequency converter

D = free space underneath the frequency converter

NOTE! See the mounting dimensions on the back of the drive.

Leave **free space** for cooling above (**100 mm**), below (**50 mm**), and on the sides (**20 mm**) of Vacon 20! [For MI1 - MI3, side-to-side installation allowed only if the ambient temperature is below 40 °C; For MI4-MI5, side-to-side installation is not allowed.]

Type	Cooling air required (m ³ /h)
MI1	10
MI2	10
MI3	30
MI4	45
MI5	75

Table 3.5: Required cooling air

3.1.3 Power losses

If the operator wants to raise the switching frequency of the drive for some reason (typically e.g. in order to reduce the motor noise), this inevitably affects the power losses and cooling requirements, for different motor shaft power, operator can select the switching frequency according to the graphs below.

MI1 - MI5 3P 400 V POWER LOSS

MI1 400V, 2.4A, Eff., 400V, 50C

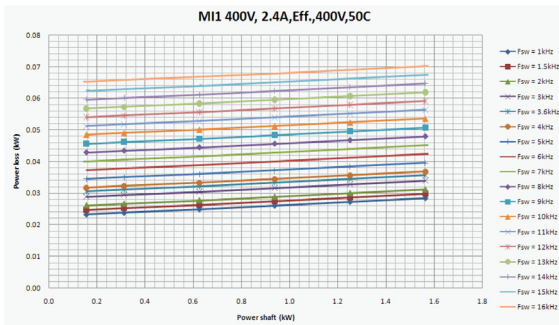

MI2 400V, 5.6A, Eff., 400V, 50C

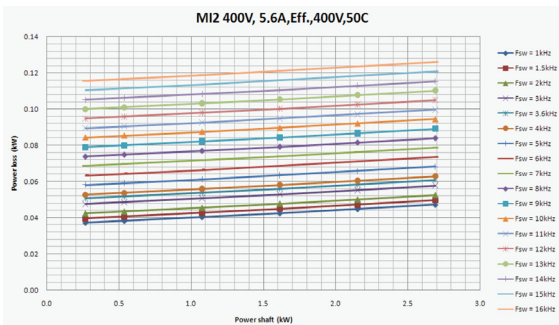

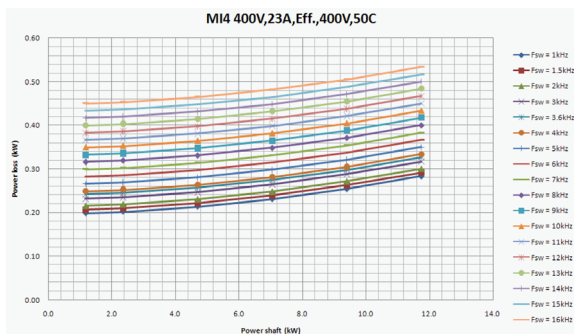
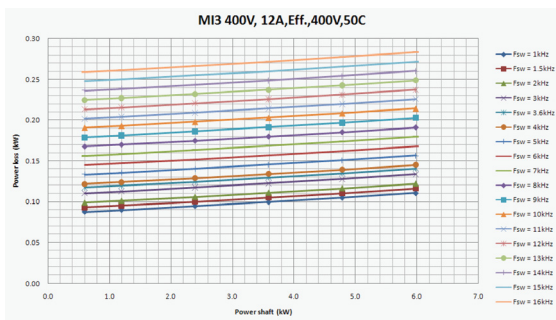

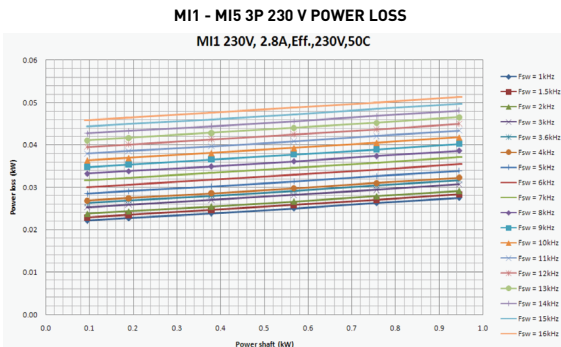
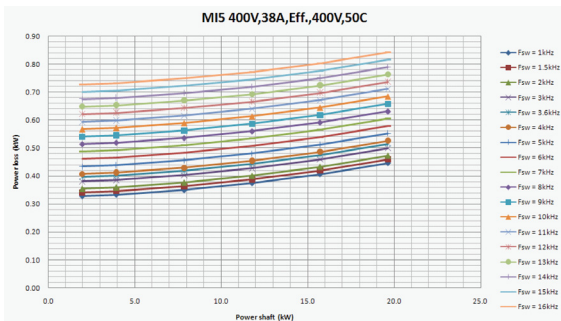

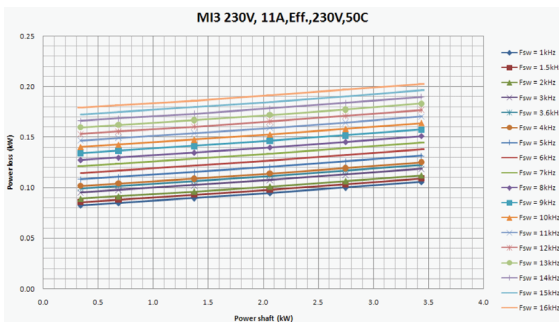
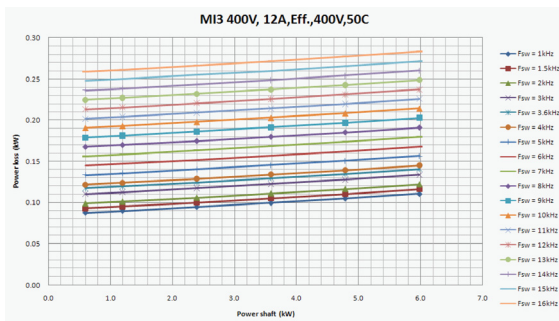

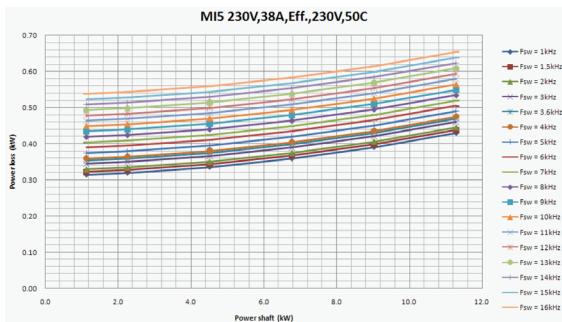
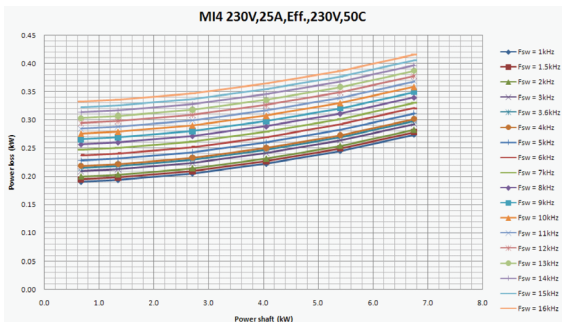

MI1 - MI3 1P 230 V POWER LOSS

MI1 230V, 2.8A, Eff., 230V, 50C

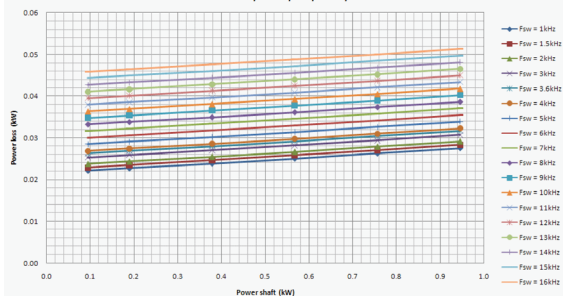

MI2 230V, 7A, Eff., 230V, 50C

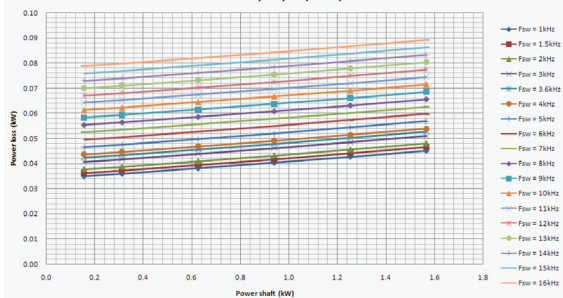

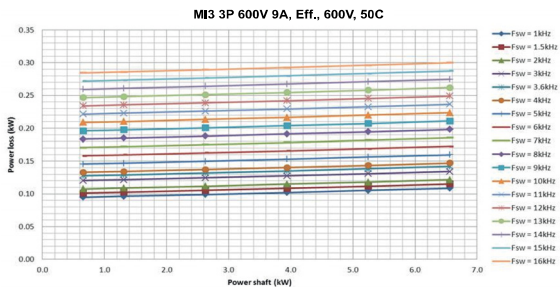
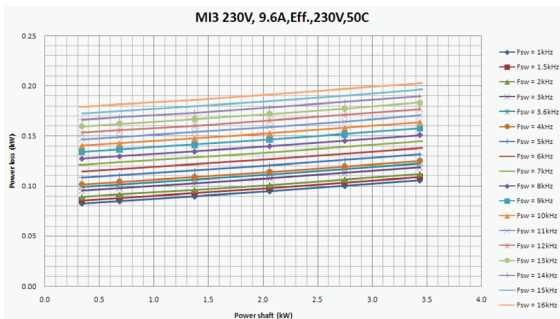

3.1.4 EMC levels

EN61800-3 defines the division of frequency converters into four classes according to the level of electromagnetic disturbances emitted, the requirements of a power system network and the installation environment (see below). The EMC class of each product is defined in the type designation code.

Category C1: Frequency converters of this class comply with the requirements of category C1 of the product standard EN 61800-3 (2004). Category C1 ensures the best EMC characteristics and it includes converters the rated voltage of which is less than 1000 V and which are intended for use in the 1st environment.

NOTE: The requirements of class C are fulfilled only as far as the conducted emissions are concerned.

Category C2: Frequency converters of this class comply with the requirements of category C2 of the product standard EN 61800-3 (2004). Category C2 includes converters in fixed installations and the rated voltage of which is less than 1000 V. The class C2 frequency converters can be used both in the 1st and the 2nd environment.

Category C4: The drives of this class do not provide EMC emission protection. These kinds of drives are mounted in enclosures.

Environments in product standard EN 61800-3 (2004)

First environment: Environment that includes domestic premises. It also includes establishments directly connected without intermediate transformers to a low-voltage power supply network which supplies buildings used for domestic purposes.

NOTE: houses, apartments, commercial premises or offices in a residential building are examples of first environment locations.

Second environment: Environment that includes all establishments other than those directly connected to a low-voltage power supply network which supplies buildings used for domestic purposes.

NOTE: industrial areas, technical areas of any building fed from a dedicated transformer are examples of second environment locations.

3.1.5 Changing the EMC protection class from C2 to C4

The EMC protection class of MI1-3 frequency converters can be changed from class C2 to class C4 (except 115V and 600V drives) by **removing the EMC-capacitor disconnecting screw**, see figure below. MI4 & 5 can also be changed by removing the EMC jumpers.

Note! Do not attempt to change the EMC level back to class C2. Even if the procedure above is reversed, the frequency converter will no longer fulfil the EMC requirements of class C2!

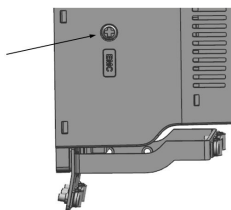

Figure 3.13: EMC protection class, MI1 - MI3

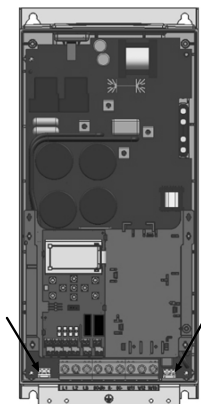

Figure 3.14: EMC protection class, MI4

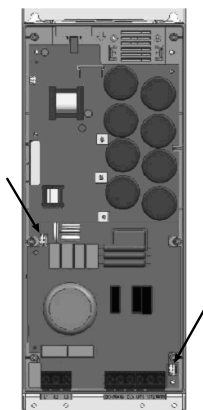

Figure 3.15: EMC protection class, M15



Figure 3.16: Jumpers

- Remove the main cover and locate the two jumpers.
- Disconnect the RFI-filters from ground by lifting the jumpers up from their default positions. See Figure 3.16.

3.2 Cabling and connections

3.2.1 Power cabling

Note! Tightening torque for power cables is 0.5 - 0.6 Nm (4-5 in.lbs).

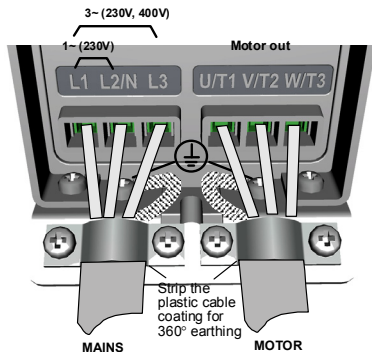

Figure 3.17: Vacon 20 power connections, MI1

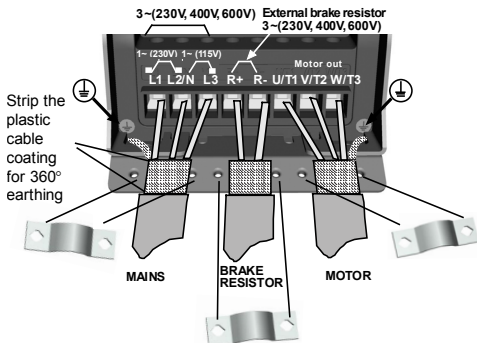

Figure 3.18: Vacon 20 power connections, MI2 - MI3

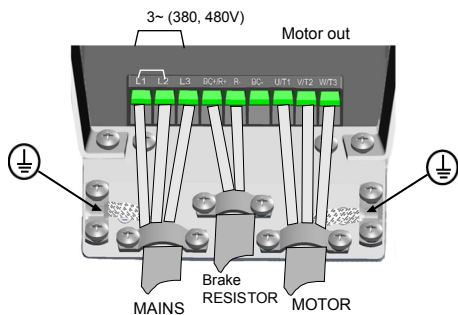

Figure 3.19: Vacon 20 power connections, MI4

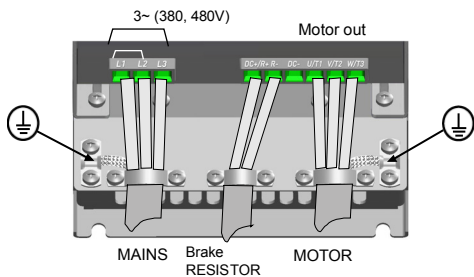

Figure 3.20: Vacon 20 power connections, MI5

3.2.2 Control cabling

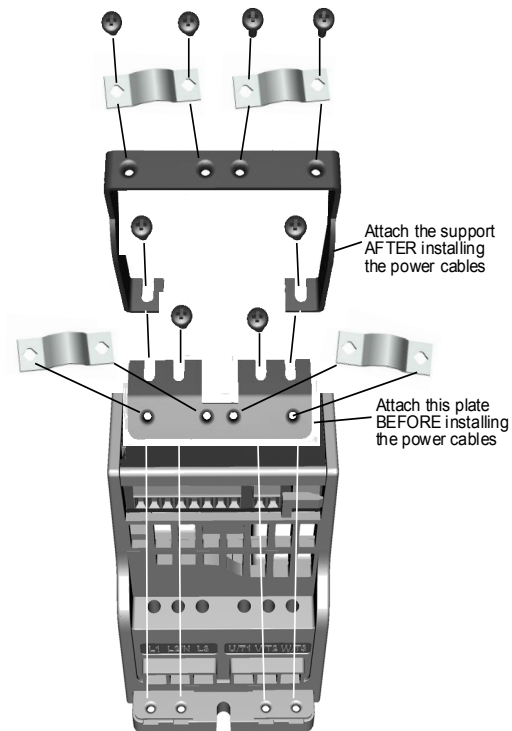

Figure 3.21: Mount the PE-plate and API cable support, MI1 - MI3

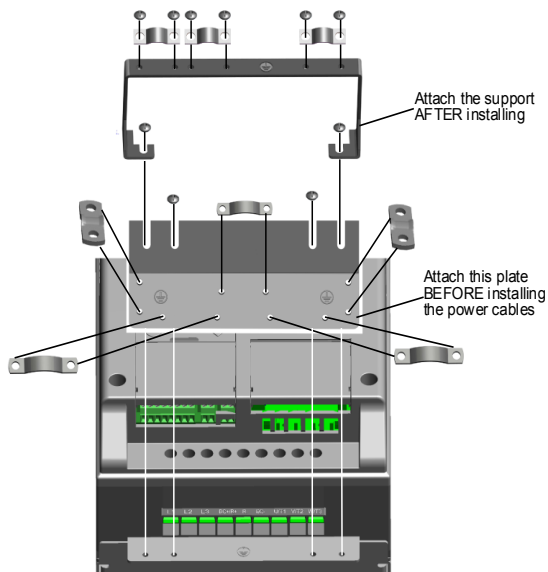

Figure 3.22: Mount the PE-plate and API cable support, MI4 - MI5

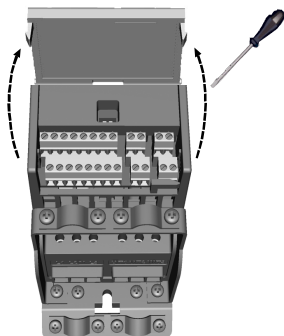

Figure 3.23: Open the lid, M11 - M13

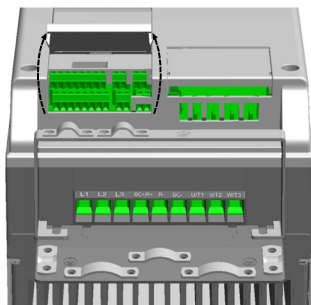

Figure 3.24: Open the lid, M14 - M15

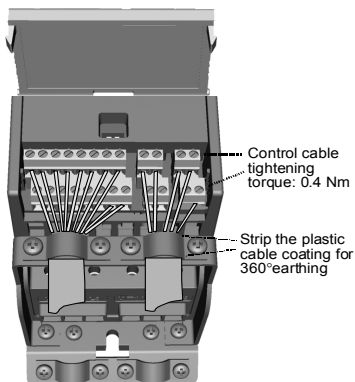

Figure 3.25: Install the control cables. MI1 - MI3. See Chapter 6.2

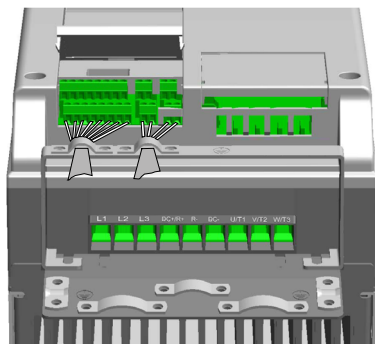

Figure 3.26: Install the control cables. MI4 - MI5. See Chapter 6.2

3.2.3 Allowed option boards in Vacon20

See below for the allowed option boards in the slot:

SLOT	EC	E3	E5	E6	E7	E9	B1	B2	B4	B5	B9	BH	BF
------	----	----	----	----	----	----	----	----	----	----	----	----	----

Note! When OPT-B1 / OPT-B4 used in Vacon20, +24VDC ($\pm 10\%$, min.300mA) power should be supplied to Terminal 6 (+24_out) and Terminal 3 (GND) in control board.

Option boards (all boards are varnished)	
OPT-EC-V	EtherCat
OPT-E3-V	Profibus DPV1 (Screw connector)
OPT-E5-V	Profibus DPV1 (D9 connector)
OPT-E6-V	CANopen
OPT-E7-V	DeviceNet
OPT-E9-V	ModbusTCP & Profinet
OPT-B1-V	6 x DI/DO, each I/O can be individually
OPT-B2-V	2 x Relay output + Thermistor
OPT-B4-V	1 x AI, 2 x AO (isolated)
OPT-B5-V	3 x Relay output
OPT-B9-V	1 x RO, 5 x DI (42-240 VAC)
OPT-BH-V	3 x Temperature measurement (support for PT100, PT1000, NI1000, KTY84-130, KTY84-150, KTY84-131 sensors)
OPT-BF-V	1 x AO, 1 x DO, 1 x RO

Option board assembly structure:

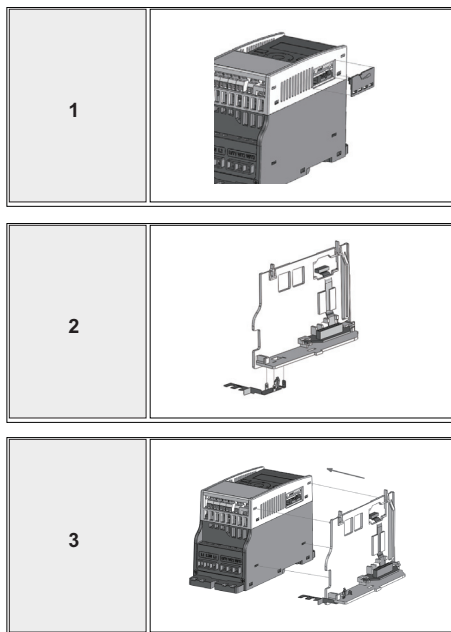

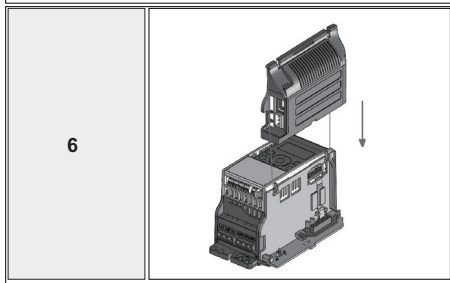
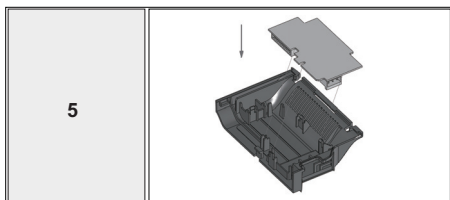
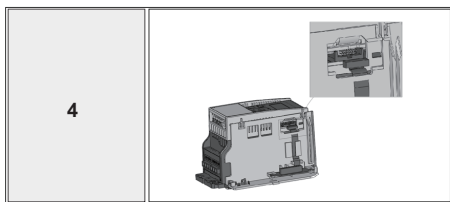

3.2.4 Screw of cables

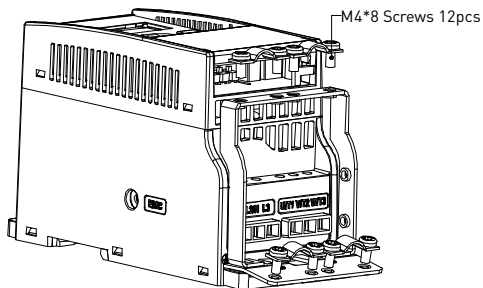

Figure 3.27: M11 screws

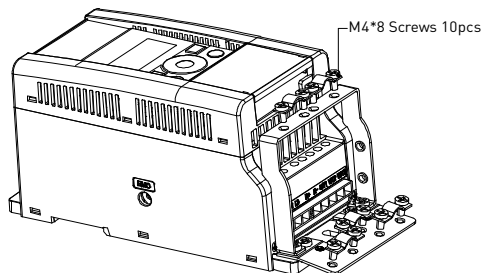

Figure 3.28: M12 screws

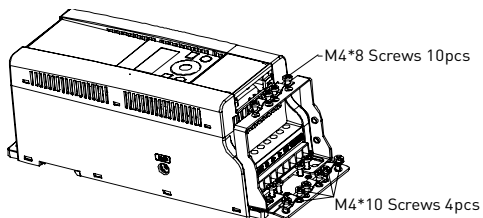

Figure 3.29: M13 screws

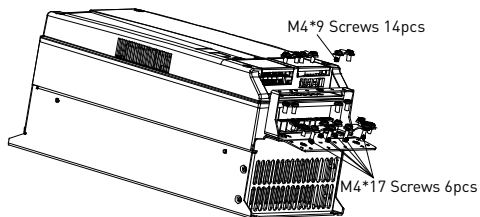

Figure 3.30: M14 - M15 screw

3.2.5 Cable and fuse specifications

Use cables with heat resistance of at least +70 °C. The cables and the fuses must be dimensioned according to the tables below. Installation of cables according to UL regulations is presented in Chapter 3.2.8.

The fuses function also as cable overload protection.

These instructions apply only to cases with one motor and one cable connection from the frequency converter to the motor. In any other case, ask the factory for more information.

EMC category	cat. C2	cat. C4
Mains cable types	1	1
Motor cable types	3	1
Control cable types	4	4

Table 3.6: Cable types required to meet standards. EMC categories are described in Chapter 3.1.4

Cable type	Description
1	Power cable intended for fixed installation and the specific mains voltage. Shielded cable not required. (NKCABLES / MCMK or similar recommended)
2	Power cable equipped with concentric protection wire and intended for the specific mains voltage. (NKCABLES / MCMK or similar recommended).
3	Power cable equipped with compact low-impedance shield and intended for the specific mains voltage. (NKCABLES / MCCMK, SAB / ÖZCUY-J or similar recommended). *360° earthing of both motor and FC connection required to meet the standard
4	Screened cable equipped with compact low-impedance shield (NKCA-BLES / Jamak, SAB / ÖZCuY-0 or similar).

Table 3.7: Cable type descriptions

Frame	Type	Fuse [A]	Mains cable Cu [mm ²]	Motor cable Cu [mm ²]	Terminal cable size (min/max)			
					Main terminal [mm ²]	Earth terminal [mm ²]	Control terminal [mm ²]	Relay terminal [mm ²]
MI2	0001-0004	20	2*2.5+2.5	3*1.5+1.5	1.5-4	1.5-4	0.5-1.5	0.5-1.5
MI3	0005	32	2*6+6	3*1.5+1.5	1.5-4	1.5-4	0.5-1.5	0.5-1.5

Table 3.8: Cable and fuse sizes for Vacon 20, 115 V, 1~

Frame	Type	Fuse [A]	Mains cable Cu [mm ²]	Motor cable Cu [mm ²]	Terminal cable size (min/max)			
					Main terminal [mm ²]	Earth terminal [mm ²]	Control terminal [mm ²]	Relay terminal [mm ²]
MI1	0001-0003	10	2*1.5+1.5	3*1.5+1.5	1.5-4	1.5-4	0.5-1.5	0.5-1.5
MI2	0004-0007	20	2*2.5+2.5	3*1.5+1.5	1.5-4	1.5-4	0.5-1.5	0.5-1.5
MI3	0009	32	2*6+6	3*1.5+1.5	1.5-6	1.5-6	0.5-1.5	0.5-1.5

Table 3.9: Cable and fuse sizes for Vacon 20, 208 - 240 V, 1~

Frame	Type	Fuse [A]	Mains cable Cu [mm ²]	Motor cable Cu [mm ²]	Terminal cable size (min/max)			
					Main terminal [mm ²]	Earth terminal [mm ²]	Control terminal [mm ²]	Relay terminal [mm ²]
MI1	0001-0003	6	3*1.5+1.5	3*1.5+1.5	1.5-4	1.5-4	0.5-1.5	0.5-1.5
MI2	0004-0007	10	3*1.5+1.5	3*1.5+1.5	1.5-4	1.5-4	0.5-1.5	0.5-1.5
MI3	0011	20	3*2.5+2.5	3*2.5+2.5	1.5-6	1.5-6	0.5-1.5	0.5-1.5
MI4	0012-0025	20 25 40	3*6+6	3*6+6	1-10Cu	1-10	0.5-1.5	0.5-1.5
MI5	0031-0038	40	3*10+10	3*10+10	2.5-50 Cu / Al	2.5-35	0.5-1.5	0.5-1.5

Table 3.10: Cable and fuse sizes for Vacon 20, 208 - 240 V, 3~

Frame	Type	Fuse [A]	Mains cable Cu [mm ²]	Motor cable Cu [mm ²]	Terminal cable size (min/max)			
					Main terminal [mm ²]	Earth terminal [mm ²]	Control terminal [mm ²]	Relay terminal [mm ²]
MI1	0001-0003	6	3*1.5+1.5	3*1.5+1.5	1.5-4	1.5-4	0.5-1.5	0.5-1.5
MI2	0004-0006	10	3*1.5+1.5	3*1.5+1.5	1.5-4	1.5-4	0.5-1.5	0.5-1.5
MI3	0008-0012	20	3*2.5+2.5	3*2.5+2.5	1.5-6	1.5-6	0.5-1.5	0.5-1.5
MI4	0016-0023	25	3*6+6	3*6+6	1-10Cu	1-10	0.5-1.5	0.5-1.5
MI5	0031-0038	40	3*10+10	3*10+10	2.5-50 Cu / Al	2.5-35	0.5-1.5	0.5-1.5

Table 3.11: Cable and fuse sizes for Vacon 20, 380 - 480 V, 3~

Frame	Type	Fuse [A]	Mains cable Cu [mm ²]	Motor cable Cu [mm ²]	Terminal cable size (min/max)			
					Main terminal [mm ²]	Earth terminal [mm ²]	Control terminal [mm ²]	Relay terminal [mm ²]
MI3	0002-0004	6	3*1.5+1.5	3*1.5+1.5	1.5-4	1.5-4	0.5-1.5	0.5-1.5
MI3	0005-0006	10	3*1.5+1.5	3*1.5+1.5	1.5-4	1.5-4	0.5-1.5	0.5-1.5
MI3	0009	20	3*2.5+2.5	3*2.5+2.5	1.5-6	1.5-6	0.5-1.5	0.5-1.5

Table 3.12: Cable and fuse sizes for Vacon 20, 600 V, 3~

Note! To fulfil standard EN61800-5-1, the protective conductor should be **at least 10 mm² Cu or 16 mm² Al**. Another possibility is to use an additional protective conductor of at least the same size as the original one.

3.2.6 General cabling rules

1	Before starting the installation, check that none of the components of the frequency converter is live.
2	Place the motor cables sufficiently far from other cables: <ul style="list-style-type: none"> • Avoid placing the motor cables in long parallel lines with other cables. • If the motor cable runs in parallel with other cables, the minimum distance between the motor cable and other cables is 0.3 m. • The given distance also applies between the motor cables and signal cables of other systems. • The maximum length of the motor cables for MI1-3 is 30 m. For MI4 & 5, maximum length is 50 m, if use longer cable, current accuracy will be decreased. • The motor cables should cross other cables at an angle of 90 degrees.
3	If cable insulation checks are needed, see Chapter 3.2.9.
4	Connecting the cables: <ul style="list-style-type: none"> • Strip the motor and mains cables as advised in Figure 3.31. • Connect the mains, motor and control cables into their respective terminals, see Figures 3.17 - 3.26. • Note the tightening torques of power cables and control cables given in chapter 3.2.1 and 3.2.2. • For information on cable installation according to UL regulations see Chapter 3.2.8. • Make sure that the control cable wires do not come in contact with the electronic components of the unit. • If an external brake resistor (option) is used, connect its cable to the appropriate terminal. • Check the connection of the earth cable to the motor and the frequency converter terminals marked with <div style="text-align: center; margin: 5px 0;">  </div> • Connect the separate shield of the motor cable to the earth plate of the frequency converter, motor and the supply centre.

3.2.7 Stripping lengths of motor and mains cables

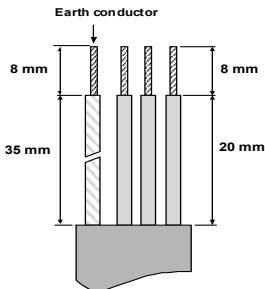

Figure 3.31: Stripping of cables

Note! Strip also the plastic cover of the cables for 360 degree earthing. See Figures 3.17, 3.18 and 3.25.

3.2.8 Cable installation and the UL standards

To meet the UL (Underwriters Laboratories) regulations, a UL-approved copper cable with a minimum heat-resistance of +60 / 75 °C must be used.

Use Class 1 wire only.

The units are suitable for use on a circuit capable of delivering not more than 50,000 rms symmetrical amperes, 600V maximum, when protected by T and J Class fuses. For MI4 without DC-choke, maximum short circuit current has to be not more than 2.3 kA, for MI5 without DC-choke, maximum short circuit current has to be not more than 3.8 kA.

Integral solid state short circuit protection does not provide branch circuit protection. Branch circuit protection must be provided in accordance with the National Electric Code and any additional local codes. Branch circuit protection provided by fuses only.

Motor overload protection provided at 110% of full load current.

3.2.9 Cable and motor insulation checks

These checks can be performed as follows if motor or cable insulations are suspected to be faulty.

1. Motor cable insulation checks

Disconnect the motor cable from terminals U / T1, V / T2 and W / T3 of the frequency converter and from the motor. Measure the insulation resistance of the motor cable

between each phase conductor as well as between each phase conductor and the protective ground conductor.

The insulation resistance must be >1 M Ω m.

2. Mains cable insulation checks

Disconnect the mains cable from terminals L1, L2 / N and L3 of the frequency converter and from the mains. Measure the insulation resistance of the mains cable between each phase conductor as well as between each phase conductor and the protective ground conductor. The insulation resistance must be >1 M Ω m.

3. Motor insulation checks

Disconnect the motor cable from the motor and open the bridging connections in the motor connection box. Measure the insulation resistance of each motor winding. The measurement voltage must equal at least the motor nominal voltage but not exceed 1000 V. The insulation resistance must be >1 M Ω m.

4. COMMISSIONING

Before commissioning, read the warnings and instructions listed in Chapter 1!

4.1 Commissioning steps of Vacon 20

1	Read carefully the safety instructions in Chapter 1 and follow them.
2	<p>After the installation, make sure that:</p> <ul style="list-style-type: none"> • both the frequency converter and the motor are grounded. • the mains and motor cables comply with the requirements given in Chapter 3.2.5. • the control cables are located as far as possible from the power cables (see Chapter 3.2.6, step 2) and the shields of the shielded cables are connected to protective earth. <div style="text-align: center;">  </div>
3	Check the quality and quantity of cooling air (Chapter 3.1.2).
4	Check that all Start / Stop switches connected to the I / O terminals are in Stop -position.
5	Connect the frequency converter to mains.
6	<p>Set the parameters of group 1 according to the requirements of your application. At least the following parameters should be set:</p> <ul style="list-style-type: none"> • motor nominal speed (par. 1.3) • motor nominal current (par. 1.4) • application type (par. 17.1) <p>You will find the values needed for the parameters on the motor rating plate.</p>

7	<p>Perform test run without motor. Perform either Test A or Test B:</p> <p>A) Control from the I / O terminals:</p> <ul style="list-style-type: none"> • Turn the Start/Stop switch to ON position. • Change the frequency reference (potentiometer). • Check the Monitoring Menu and make sure that the value of Output frequency changes according to the change of frequency reference. • Turn the Start / Stop switch to OFF position. <p>B) Control from the keypad:</p> <ul style="list-style-type: none"> • Select the keypad as the control place with par 2.1. You can also move to keypad control by pressing Loc / Rem button or select Local control with par 2.5. • Push the Start button on the keypad. • Check the Monitoring Menu and make sure that the value of Output frequency changes according to the change of frequency reference. • Push the Stop button on the keypad.
8	<p>Run the no-load tests without the motor being connected to the process, if possible. If this is impossible, secure the safety of each test prior to running it. Inform your co-workers of the tests.</p> <ul style="list-style-type: none"> • Switch off the supply voltage and wait up until the drive has stopped. • Connect the motor cable to the motor and to the motor cable terminals of the frequency converter. • See to that all Start / Stop switches are in Stop positions. • Switch the mains ON. • Repeat test 7A or 7B.
9	<p>Perform an identification run (see par. 1.18), especially if the application requires a high startup torque or a high torque with low speed.</p>
10	<p>Connect the motor to the process (if the no-load test was running without the motor being connected).</p> <ul style="list-style-type: none"> • Before running the tests, make sure that this can be done safely. • Inform your co-workers of the tests. • Repeat test 7A or 7B.

5. FAULT TRACING

When a fatal fault is detected by the frequency converter control electronics, the drive will stop and the symbol FT and the fault code blinked on the display are in the following format, e.g.:

FT 2

— Fault code (02 = overvoltage)

The active fault can be reset by pressing BACK / RESET button when the API is in active fault menu level (FT XX), or pressing BACK / RESET button with long time (> 2 s) when the API is in active fault submenu level (F5.x), or via the I / O terminal or field bus. Reset fault history (long push > 5 s), when the API is in fault history submenu level (F6.x). The faults with subcode and time labels are stored in the Fault history submenu which can be browsed. The different fault codes, their causes and correcting actions are presented in the table below.

Fault code	Fault name	Possible cause	Correcting actions
1	Overcurrent	Frequency converter has detected too high a current ($>4 \cdot I_N$) in the motor cable: <ul style="list-style-type: none"> • sudden heavy load increase • short circuit in motor cables • unsuitable motor 	Check loading. Check motor size. Check cables.
2	Overvoltage	The DC-link voltage has exceeded the internal safety limit: <ul style="list-style-type: none"> • deceleration time is too short • high overvoltage peaks in mains 	Increase the deceleration time (Par.4.3 or Par.4.6)
3	Earth fault	Current measurement has detected extra leakage current at start: <ul style="list-style-type: none"> • insulation failure in cables or motor 	Check motor cables and motor

Table 5.1: Fault codes

Fault code	Fault name	Possible cause	Correcting actions
8	System fault	<ul style="list-style-type: none"> • component failure • faulty operation 	Reset the fault and restart. If the fault re-occurs, contact the distributor near to you. NOTE! If fault F8 occurs, find out the subcode of the fault from the Fault History menu under Id xxx!
9	Under voltage	The DC-link voltage has gone below the internal safety limit: <ul style="list-style-type: none"> • most probable cause: supply voltage is too low • frequency converter internal fault • Power outages 	In case of temporary supply voltage break reset the fault and restart the frequency converter. Check the supply voltage. If it is adequate, an internal failure has occurred. Contact the distributor near to you.
10	Input phase fault	Input phase is missing	Check supply voltage, fuses and cable.
11	Output phase fault	Current measurement has detected that there is no current in one motor phase.	Check motor cable and motor.
13	Frequency converter under temperature	Heat sink temperature is under -10 °C	Check the ambient temperature.
14	Frequency converter over temperature	Heat sink is overheated.	Check that the cooling air flow is not blocked. Check the ambient temperature. Clean the heatsink dust. Make sure that the switching frequency is not too high in relation to ambient temperature and motor load.
15	Motor stalled	Motor stall protection has tripped.	Check that the motor is able to rotate freely.
16	Motor over temperature	Motor overheating has been detected by frequency converter motor temperature model. Motor is overloaded.	Decrease the motor load. If no motor overload exists, check the temperature model parameters.

Table 5.1: Fault codes

Fault code	Fault name	Possible cause	Correcting actions
17	Motor underload	Motor underload protection has tripped.	Check motor and load, e.g. for broken belts or dry pumps.
22	EEPROM checksum fault	Parameter save fault <ul style="list-style-type: none"> • faulty operation • component failure 	Contact the distributor near to you.
25	Microcontroller watchdog fault	<ul style="list-style-type: none"> • faulty operation • component failure 	Reset the fault and restart. If the fault re-occur, contact the distributor near to you.
27	Back EMF protection	Drive has detected that the magnetized motor is running in start situation. <ul style="list-style-type: none"> • A rotating PM-motor 	Make sure that there is no rotating PM-motor when the start command is given.
29	Thermistor fault	The thermistor input of option board has detected increase of the motor temperature.	Check motor cooling and loading. Check thermistor connection (If thermistor input of the option board is not in use it has to be short circuited).
34	Internal bus communication	Ambient interference or defective hardware.	If the fault re-occur, contact the distributor near to you.
35	Application fault	Application is not working properly.	Contact the distributor near to you.
41	IGBT Overtemperature	Overtemperature alarm is issued when the IGBT switch temperature exceeds 110 °C.	Check loading. Check motor size. Make identification run.
50	Analog input select 20% - 100% (selected signal range 4 to 20 mA or 2 to 10 V)	Current at the analogue input is < 4mA; Voltage at the analogue input is < 2 V. <ul style="list-style-type: none"> • control cable is broken or loose. • signal source has failed. 	Check the current loop circuitry.
51	External fault	Digital input fault. Digital input has been programmed as external fault input and this input is active.	Remove the external device fault.

Table 5.1: Fault codes

Fault code	Fault name	Possible cause	Correcting actions
52	Door Panel fault	Control place is keypad, but door panel has been disconnected.	Check the connection between optional board and API. If connection is correct, contact the nearest Vacon distributor.
53	Fieldbus fault	The data connection between the fieldbus Master and the fieldbus of the drive has broken.	Check installation. If installation is correct, contact the nearest Vacon distributor.
54	Slot fault	The connection between optional board and API has been broken.	Check board and slot. Contact the nearest Vacon distributor.
55	Wrong run fault (FWD/REV conflict)	Run forward and backward are high at the same time.	Check I/O control signal 1 and I/O control signal 2.
57	Identification fault	Identification run has failed.	Run command was removed before completion of identification run. Motor is not connected to frequency converter. There is load on motor shaft.
111	Temperature fault	Over low or over high temperature	Check temperature signal from OPTBH board

Table 5.1: Fault codes

F08 SubCode	Fault
60	Watchdog reset
61	SW stack overflow
62	HW stack overflow
63	Misalignment
64	Illegal op
65	PLL lost lock / Low CPU voltage
66	EEPROM Device
67	EEPROM Queue full
68	MPI communication (dead or CRC errors)
70	CPU load

Table 5.2: Fault subcodes from power

F08 SubCode	Fault
71	External oscillator
72	Fault in Power triggered by user

Table 5.2: Fault subcodes from power

F08 SubCode	Fault
84	MPI CRC
86	MPI2 CRC
89	HMI receive buffer overflow
90	MODBUS receive buffer overflow
93	Power source cannot be recognized (triggered as alarm)
96	MPI queue full
97	MPI off line error
98	MPI driver error
99	Option Board Driver Error
100	Option Board Configure Error
104	OBI channel full
105	OBI memory allocate fail
106	OBI object queue full
107	OBI HMI queue full
108	OBI SPI queue full
111	Parameter copy error
113	Frequency detective timer overflow
114	PC control time out error
115	Device Property data format tree too deep exceed 3
120	Task stack overflow

Table 5.2: Fault Subcodes from control API

F22 SubCode	Fault
1	DA_CN, Power down data counter error
2	DA_PD, Power down data restore fail
3	DA_FH, Fault history data error

Table 5.2: Fault subcodes

F22 SubCode	Fault
4	DA_PA, Restore parameter CRC error
5	Reserved.
6	DA_PER_CN, Persist data counter error
7	DA_PER_PD, Persist data restore fail

Table 5.2: Fault subcodes

F35 SubCode	Fault
1	Application software flash error
2	Application header error

Table 5.2: Fault subcodes

6. VACON 20 APPLICATION INTERFACE

6.1 Introduction

There is only one version of Control Board available for the Vacon 20 drive:

Version	Composition
Vacon 20	6 Digital inputs
	2 Analogue inputs
	1 Analogue output
	1 Digital output
	2 Relay outputs
	RS-485 Interface

Table 6.1: Available Control Board

This section provides you with a description of the I / O-signals for Vacon 20 and instructions for using the Vacon 20 general purpose application.

The frequency reference can be selected from Preset Speed 0, Keypad, Fieldbus, AI1, AI2, AI1+AI2, PID, Motor potentiometer and Pulse train / Encoder.

Basic properties:

- Digital inputs DI1...DI6 are freely programmable. The user can assign a single input to many functions.
- Digital-, relay- and analogue outputs are freely programmable.
- Analog output can be programmed as current or voltage output.
- Analog input 1 can be as voltage input, analog input 2 can be programmed as current or voltage input.
- DI5/6 can be used as pulse train or Encoder.

Special features:

- Programmable Start / Stop and Reverse signal logic
- Motor pre-heat
- Reference scaling
- DC-brake at start and stop
- Programmable U / f curve
- Adjustable switching frequency
- Autoreset function after fault

- Protections and supervisions (all fully programmable; off, alarm, fault):
 - Analog input low fault
 - External fault
 - Undervoltage fault
 - Earth fault
 - Motor thermal, stall and underload protection
 - Fieldbus communication
 - Output phase fault
 - Thermistor fault
- 8 preset speeds
- Analogue input range selection, signal scaling and filtering
- PID-controller

6.2 Control I / O

1-10 k Ω

Terminal	Signal	Factory preset	Description
1	+10 Vref	Ref. voltage out	Maximum load 10 mA
2	AI1	Analog signal in 1	Freq. reference ^{P1} 0 - 10 V, Ri = 250 k Ω
3	GND	I / O signal ground	
6	24 Vout	24 V output for DI's	\pm 20%, max. load 50 mA
7	DI_C	Digital Input Common	Digital Input Common for DI1-DI6, refer to Table 6.3 for DI sink type
8	DI1	Digital input 1	Start forward ^{P1} Positive, Logic1: 18...30V, Logic0: 0...5V;
9	DI2	Digital input 2	Start reverse ^{P1} Negative, Logic1: 0...10V, Logic0: 18...30V; Ri = 10K Ω (floating)
10	DI3	Digital input 3	Fault reset ^{P1}
A	A	RS485 signal A	FB Communication Negative
B	B	RS485 signal B	FB Communication Positive
4	AI2	Analog signal in 2	PID actual value and Freq. reference ^{P1} Default: 0(4) - 20 mA, Ri \leq 250 Ω Other: 0 - + 10 V, Ri = 250 k Ω Selectable through microswitch
5	GND	I / O signal ground	
13	DO-	Digital Output Common	Digital Output Common
14	DI4	Digital input 4	Preset speed B0 ^{P1} As DI1
15	DI5	Digital input 5	Preset speed B1 ^{P1} Other: Encoder Input A (frequency up to 10 kHz) Selectable through microswitch
16	DI6	Digital input 6	External Fault ^{P1} As DI1, Other: Encoder Input B (frequency up to 10 kHz), Pulse Train Input (frequency up to 5 kHz)
18	AO	Analog Output	Output frequency ^{P1} 0 - 10 V, RL \geq 1 K Ω 0(4) - 20 mA, RL \leq 500 Ω Selectable through microswitch
20	DO	Digital signal out	Active = READY ^{P1} Open collector, max. load 35 V / 50 mA

Table 6.2: Vacon 20 General purpose application default I / O configuration and connections for control board

^{P1}) = Programmable function, see parameter lists and descriptions, chapters 8 and 9.

Terminal	Signal	Factory preset	Description
22	R01 NO	Relay out 1	Active = RUN ^{PI} Switching load: 250 Vac / 3 A, 24V DC 3A
23	R01 CM		
24	R02 NC	Relay out 2	Active = FAULT ^{PI} Switching load: 250 Vac / 3 A, 24V DC 3A
25	R02 CM		
26	R02 NO		

Table 6.2: Vacon 20 General purpose application default I / O configuration and connections for control board

^{PI}) = Programmable function, see parameter lists and descriptions, chapters 8 and 9.

Terminal	Signal	Factory preset	Description
3	GND	I / O signal ground	
6	24 Vout	24 V output for DI's	±20%, max. load 50 mA
7	DI_C	Digital Input Common	Digital Input Common for DI1-DI6
8	DI1	Digital input 1	Start forward ^{PI} Positive, Logic1: 18...+30V, Logic0: 0...5V; Negative, Logic1: 0...10V, Logic0: 18...30V; Ri = 10KΩ (floating)
9	DI2	Digital input 2	Start reverse ^{PI}
10	DI3	Digital input 3	Fault reset ^{PI}
14	DI4	Digital input 4	Preset speed B0 ^{PI} Positive, Logic1: 18...+30V, Logic0: 0...5V; Negative, Logic1: 0...10V, Logic0: 18...30V; Ri = 10KΩ (floating)
15	DI5	Digital input 5	Preset speed B1 ^{PI} Only for DI.
16	DI6	Digital input 6	External Fault ^{PI} Only for DI.

Table 6.3: DI Sink Type, remove jumper J500 and connect the wire using table 6.3

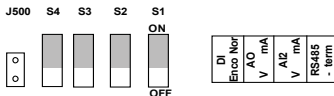
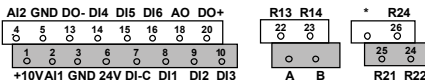

Figure 6.1: Microswitches

Vacon 20 I / O terminals:



7. CONTROL PANEL

7.1 General

The panel is an irremovable part of the drive consisting of corresponding control board; The overlay with display status on the cover and the button are in clarifications in the user language.

The User Panel consists of an alphanumeric LCD display with backlight and a keypad with the 9 push buttons (see Figure 7.1).

7.2 Display

The display includes 14-segment and 7-segment blocks, arrowheads and clear text unit symbols. The arrowheads, when visible, indicate some information about the drive, which is printed in clear text in user language on the overlay (numbers 1...14 in the figure below). The arrowheads are grouped in 3 groups with the following meanings and English overlay texts (see Figure 7.1):

Group 1 - 5; Drive status

- 1= Drive is ready to start (READY)
- 2= Drive is running (RUN)
- 3= Drive has stopped (STOP)
- 4= Alarm condition is active (ALARM)
- 5= Drive has stopped due to a fault (FAULT)

Group 6 - 10; Control selections

When API is operated by PC control, there are no arrowhead at I / O, KEYPAD and BUS.

- 6= Motor is rotating forward (FWD)
- 7= Motor is rotating reverse (REV)
- 8= I/O terminal block is the selected control place (I / O)
- 9= Keypad is the selected control place (KEYPAD)
- 10= Fieldbus is the selected control place (BUS)

Group 11 - 14; Navigation main menu

- 11= Reference main menu (REF)
- 12= Monitoring main menu (MON)
- 13= Parameter main menu (PAR)
- 14= System main menu (SYS)



Figure 7.1: Vacon 20 Control panel

7.3 Keypad

The keypad section of the control panel consists of 9 buttons (see Figure 7.1). The buttons and their functions are described as Table 7.1.

The drive stops by pressing the keypad STOP button, regardless of the selected control place when Par. 2.7 (Keypad stop button) is 1. If Par. 2.7 is 0, the drive stops by keypad STOP button only when control place is keypad. The drive starts by pressing the keypad START button when the selected control place is KEYPAD or LOCAL control.









Symbol	Button Name	Function Description
	Start	Motor START from the panel
	STOP	Motor STOP from the panel
	OK	Used for confirmation. Enter edit mode for parameter. Alternate in display between the parameter value and parameter code. Reference frequency value adjusting no need to press OK-button to confirm.
	Back / Reset	Cancels edited parameter Move backwards in menu levels Reset fault indication
 	Up and Down	Select root parameter number on root-parameter list, Up decrease / Down increase parameter number, Up increase / Down decrease parameter value change.
 	Left and Right	Available in REF, PAR and SYS menu parameter digit setting when changing value. MON, PAR and SYS can also use left and right button to navigate the parameter group, like e.g., in MON menu use right button from V1.x to V2.x to V3.x. Can be used to change direction in REF menu in local mode: -Right arrow would mean reverse (REV) -Left arrow would mean forward (FWD)
	Loc / Rem	Change control place

Table 7.1: Keypad Function

NOTE! The status of all the 9 buttons are available for application program!

7.4 Navigation on the Vacon 20 control panel

This chapter provides you with information on navigating the menus on Vacon 20 and editing the values of the parameters.

7.4.1 Main menu

The menu structure of Vacon 20 control software consists of a main menu and several submenus. Navigation in the main menu is shown below:

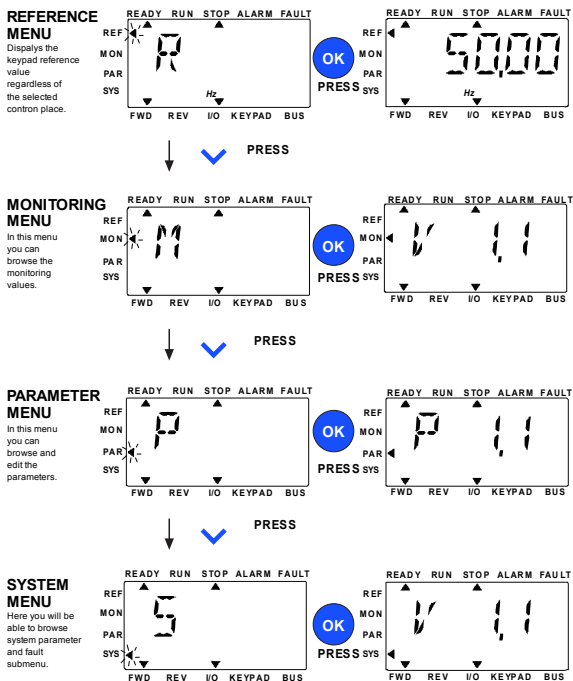

Figure 7.2: The main menu of Vacon 20

7.4.2 Reference menu

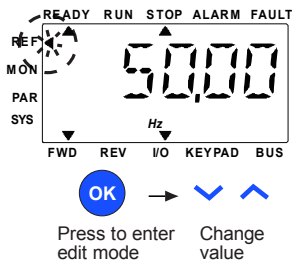

Figure 7.3: Reference menu display

Move to the reference menu with the UP / DOWN button (see Figure 7.2). The reference value can be changed with UP / DOWN button as shown in Figure 7.3.

If the value has big change, first press Left and Right buttons to select the digit which has to be changed, then press Up button to increase and Down button to decreases the value in the selected digit . The changing reference frequency will be taken into use immediately without pressing OK.

Note! LEFT and RIGHT buttons can be used to change the direction in Ref menu in local control mode.

7.4.3 Monitoring menu

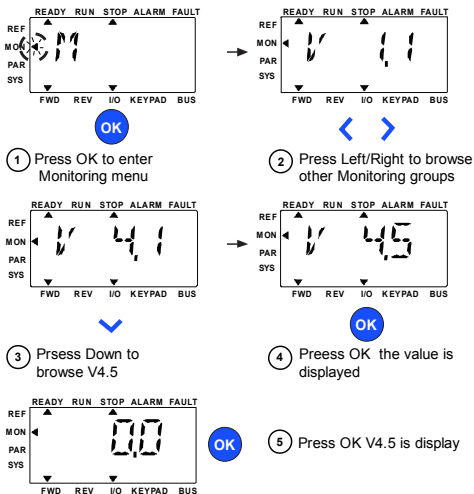

Figure 7.4: Monitoring menu display

Monitoring values are actual values of measured signals as well as status of some control settings. It is visible in Vacon 20 display, but it can not be edited. The monitoring values are listed in Table 7.2.

Pressing Left/Right button to change the actual parameter to the first parameter of the next group, to browse monitor menu from V1.x to V2.1 to V3.1 to V4.1. After entering the desired group, the monitoring values can be browsed by pressing UP / DOWN button, as shown in Figure 7.4.

In MON menu the selected signal and its value are alternating in the display by pressing OK button.

Note! Turn on drive power, arrowhead of main menu is at MON, V x.x or monitor parameter value of Vx.x is displayed in Panel.

Display Vx.x or monitor parameter value of Vx.x is determined by the last show status before power shut down. E.g., it was V4.5, and it is also V4.5 when restart.

Code	Monitoring signal	Unit	ID	Description
V1.1	Output frequency	Hz	1	Output frequency to motor
V1.2	Frequency reference	Hz	25	Frequency reference to motor control
V1.3	Motor speed	rpm	2	Calculated motor speed
V1.4	Motor current	A	3	Measured motor current
V1.5	Motor torque	%	4	Calculated actual / nominal torque of the motor
V1.6	Motor shaft power	%	5	Calculated actual / nominal power of the motor
V1.7	Motor voltage	V	6	Motor voltage
V1.8	DC-link voltage	V	7	Measured DC-link voltage
V1.9	Unit temperature	°C	8	Heatsink temperature
V1.10	Motor temperature	%	9	Calculated motor temperature
V1.11	Output Power	KW	79	Output power from drive to motor
V2.1	Analog input 1	%	59	AI1 signal range in percent of used range
V2.2	Analog input 2	%	60	AI2 signal range in percent of used range
V2.3	Analog output	%	81	AO signal range in percent of used range
V2.4	Digital input status DI1, DI2, DI3		15	Digital input status
V2.5	Digital input status DI4, DI5, DI6		16	Digital input status
V2.6	R01, R02, D0		17	Relay / digital output status
V2.7	Pulse train / encoder input	%	1234	0 - 100% scale value
V2.8	Encoder rpm	rpm	1235	Scaled according to Encoder pulses / revolution parameter
V2.11	Analog input E1	%	61	Analogue input signal 1 in % from option board, hidden until an option board is connected
V2.12	Analog output E1	%	31	Analogue output signal 1 in % from option board, hidden until an option board is connected

Table 7.2: Monitoring values

Code	Monitoring signal	Unit	ID	Description
V2.13	Analog output E2	%	32	Analogue output signal 2 in % from option board, hidden until an option board is connected
V2.14	DIE1, DIE2, DIE3		33	This monitor value shows status of the digital inputs 1-3 from option board, hidden until an option board is connected
V2.15	DIE4, DIE5, DIE6		34	This monitor value shows status of the digital inputs 4-6 from option board, hidden until an option board is connected
V2.16	DOE1, DOE2, DOE3		35	This monitor value shows status of the relay outputs 1-3 from option board, hidden until an option board is connected
V2.17	DOE4, DOE5, DOE6		36	This monitor value shows status of the relay outputs 4-6 from option board, hidden until an option board is connected
V2.18	Temperature input 1		50	Measured value of Temperature input 1 in temperature unit (Celsius or Kelvins) by parameter setting, hidden until an option board is connected
V2.19	Temperature input 2		51	Measured value of Temperature input 2 in temperature unit (Celsius or Kelvins) by parameter setting, hidden until an option board is connected
V2.20	Temperature input 3		52	Measured value of Temperature input 3 in temperature unit (Celsius or Kelvins) by parameter setting, hidden until an option board is connected
V3.1	Drive status word		43	Bit codes status of drive B0 = Ready B1 = Run B2 = Reverse B3 = Fault B6 = RunEnable B7 = AlarmActive B12 = RunRequest B13 = MotorRegulatorActive

Table 7.2: Monitoring values

Code	Monitoring signal	Unit	ID	Description
V3.2	Application status word		89	Bit codes status of application: B3 = Ramp 2 Active B5 = Remote CTRL Place 1 active B6 = Remote CTRL Place 2 active B7 = Fieldbus Control Active B8 = Local Control Active B9 = PC Control Active B10 = Preset Frequencies Active
V3.3	DIN status word		56	B0 = DI1 B1 = DI2 B2 = DI3 B3 = DI4 B4 = DI5 B5 = DI6 B6 = DIE1 B7 = DIE2 B8 = DIE3 B9 = DIE4 B10 = DIE5 B11 = DIE6
V4.1	PID setpoint	%	20	Regulator setpoint
V4.2	PID feedback value	%	21	Regulator actual value
V4.3	PID error	%	22	Regulator error
V4.4	PID output	%	23	Regulator output
V4.5	Process		29	Scaled process variable see par. 15.18

Table 7.2: Monitoring values

7.4.4 Parameter menu

In Parameter menu only the Quick setup parameter list is shown as default. By giving the value 0 to the parameter 17.2, it is possible to open other advanced parameter groups. The parameter lists and descriptions can be found in chapters 8 and 9.

The following figure shows the parameter menu view:

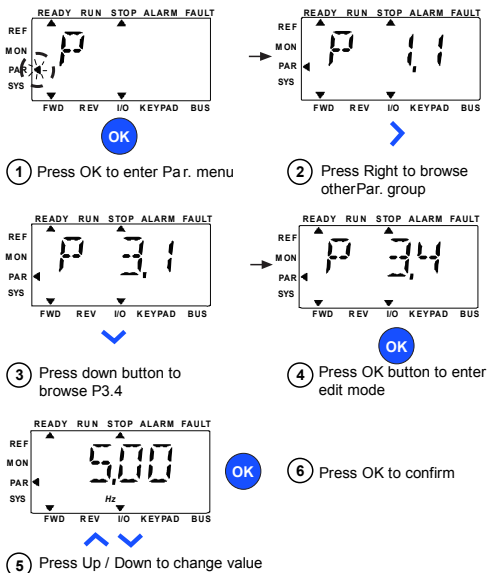

Figure 7.5: Parameter menu

The parameter can be changed as the Figure 7.5.

Left / Right button is available inside Parameter menu. Pressing Left / Right button to change the actual parameter to the first parameter of the next group (Example: any parameter of P1... is displayed -> RIGHT button -> P2.1 is displayed -> RIGHT button -> P3.1 is displayed ...). After entering the desired group, pressing UP / DOWN button to select root parameter number, and then press OK button to display the value of the parameter and also enter edit mode.

In edit mode, Left and Right buttons are used to select the digit which has to be changed, and Up increases / Down decreases parameter value.

In edit mode, the value of Px.x is displayed blinkingly in the panel. After about 10 s, Px.x is displayed in the panel again if you don't press any button.

Note! In edit mode, if you edit the value and don't press OK button, the value isn't changed successfully.

In edit mode, if you don't edit the value, you can press Reset / Back button to display Px.x again.

7.4.5 System menu

SYS menu including fault submenu, field bus submenu and system parameter submenu, and the display and operation of the system parameter submenu is similar to PAR menu or MON menu. In system parameter submenu, there are some editable parameter (P) and some uneditable parameter (V).

The Fault submenu of SYS menu includes active fault submenu and fault history submenu.

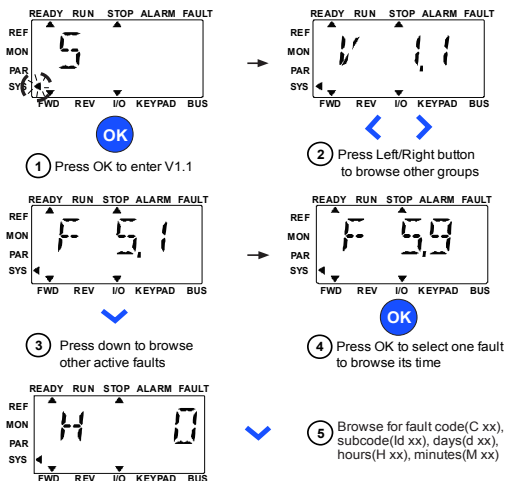

Figure 7.6: Fault menu

In active fault situation, FAULT arrow is blinking and the display is blinking active fault menu item with fault code. If there are several active faults, you can check it by entering the active fault submenu F5.x. F5.1 is always the latest active fault code. The active faults can be reset by pressing BACK / RESET button with long time (>2 s), when the API is in active fault submenu level (F5.x). If the fault cannot be reset, the blinking continues. It is possible to select other display menus during active fault, but in this case the display returns automatically to the fault menu if no button is pressed in 10 seconds. The fault code, subcode and the operating day, hour and minute values at the fault instant are shown in the value menu (operating hours = displayed reading).

Note! Fault History can be reset by long pressing the BACK / RESET button for 5 second time, when the API is in fault history submenu level (F6.x), it will also clear all active faults.

See Chapter 5 for fault descriptions.

8. STANDARD APPLICATION PARAMETERS

On the next pages you can find the lists of parameters within the respective parameter groups. The parameter descriptions are given in Chapter 9 .

Explanations:

Code: Location indication on the keypad; Shows the operator the present Monitoring value number or Parameter number

Parameter: Name of monitoring value or parameter

Min: Minimum value of parameter

Max: Maximum value of parameter

Unit: Unit of parameter value; given if available

Default: Factory preset value

ID: ID number of the parameter (used with fieldbus control)



More information on this parameter available in chapter 9: 'Parameter descriptions' click on the parameter name.



Modifiable only in stop state

NOTE: This manual is for Vacon 20 standard application only. If you need more application information, please download the appropriate user manual on <http://www.vacon.com> -> Support & Downloads.

8.1 Quick setup parameters (Virtual menu, shows when par. 17.2 = 1)

Code	Parameter	Min	Max	Unit	Default	ID	Note
P1.1	Motor nominal voltage	180	690	V	Varies	110	Check rating plate on the motor.
P1.2	Motor nominal frequency	30,00	320,00	Hz	50,00 / 60,00	111	Check rating plate on the motor.
P1.3	Motor nominal speed	30	20000	rpm	1440 / 1720	112	Default applies for a 4-pole motor.
P1.4	Motor nominal current	0,2 x I _{Nunit}	2,0 x I _{Nunit}	A	I _{Nunit}	113	Check rating plate on the motor.
P1.5	Motor cos ϕ (Power Factor)	0,30	1,00		0,85	120	Check rating plate on the motor.
i P1.7	Current limit	0,2 x I _{Nunit}	2,0 x I _{Nunit}	A	1,5 x I _{Nunit}	107	Maximum motor current
i P1.15	Torque boost	0	1		0	109	0 = Not used 1 = Used
i P2.1	Remote control place 1 selection	0	2		0	172	0 = I / O terminal 1 = Fieldbus 2 = Keypad
i P2.2	Start function	0	1		0	505	0 = Ramp 1 = Flying start
i P2.3	Stop function	0	1		0	506	0 = Coasting 1 = Ramp
P3.1	Min frequency	0,00	P3.2	Hz	0,00	101	Minimum freq reference
P3.2	Max frequency	P3.1	320,00	Hz	50,00 / 60,00	102	Maximum freq reference
i P3.3	Remote Control Place 1 frequency reference selection	1	Varies		7	117	1 = Preset speed 0 2 = Keypad 3 = Fieldbus 4 = AI1 5 = AI2 6 = PID 7 = AI1+ AI2 8 = Motor potentiometer 9 = Pulse train / Encoder 10 = AIE1 11 = Temperature input 1 12 = Temperature input 2 13 = Temperature input 3 Note: Pay attention to DI/Encoder switch position when set with 9 = Pulse train / Encoder

Table 8.1: Quick setup parameters

Code	Parameter	Min	Max	Unit	Default	ID	Note
i P3.4	Preset speed 0	P3.1	P3.2	Hz	5,00	180	Preset speed 0 is used as frequency reference when P3.3 = 1
i P3.5	Preset speed 1	P3.1	P3.2	Hz	10,00	105	Activated by digital inputs
i P3.6	Preset speed 2	P3.1	P3.2	Hz	15,00	106	Activated by digital inputs
i P3.7	Preset speed 3	P3.1	P3.2	Hz	20,00	126	Activated by digital inputs
P4.2	Acceleration time 1	0,1	3000,0	s	3,0	103	Acceleration time from 0 Hz to maximum frequency.
P4.3	Deceleration time 1	0,1	3000,0	s	3,0	104	Deceleration time from maximum frequency to 0 Hz.
P6.1	AI1 Signal range	0	1		0	379	0 = 0 - 100% 1 = 20% - 100% 20% is the same as 2 V minimum signal level.
P6.5	AI2 Signal range	0	1		0	390	0 = 0 - 100% 1 = 20% - 100% 20% is the same as 2 V or 4 mA minimum signal level.
i P14.1	Automatic reset	0	1		0	731	0 = Disable 1 = Enable
P17.2	Parameter conceal	0	1		1	115	0 = All parameters visible 1 = Only quick setup parameter group visible

Table 8.1: Quick setup parameters

8.2 Motor settings (Control panel: Menu PAR -> P1)

Code	Parameter	Min	Max	Unit	Default	ID	Note
P1.1	Motor nominal voltage	180	690	V	Varies	110	Check rating plate on the motor
P1.2	Motor nominal frequency	30,0 0	320,0 0	Hz	50,00 / 60,00	111	Check rating plate on the motor
P1.3	Motor nominal speed	30	20000	rpm	1440 / 1720	112	Default applies for a 4-pole motor.
P1.4	Motor nominal current	0,2 x I _{Nunit}	2,0 x I _{Nunit}	A	I _{Nunit}	113	Check rating plate on the motor
P1.5	Motor cos Φ (Power Factor)	0,30	1,00		0,85	120	Check rating plate on the motor
P1.6	Motor type	0	1		0	650	0 = Induction 1 = Permanent magnet
i P1.7	Current limit	0,2 x I _{Nunit}	2,0 x I _{Nunit}	A	1,5 x I _{Nunit}	107	Maximum motor current
i P1.8	Motor control mode	0	1		0	600	0 = Frequency control 1 = Open loop speed control
i P1.9	U / f ratio	0	2		0	108	0 = Linear 1 = Square 2 = Programmable
i P1.10	Field weakening point	8,00	320,0 0	Hz	50,00 / 60,00	602	Field weakening point frequency
i P1.11	Field weakening point voltage	10,0 0	200,0 0	%	100,00	603	Voltage at field weakening point as % of U _{nmot}
i P1.12	U / f mid point frequency	0,00	P1.10	Hz	50,00 / 60,00	604	Mid point frequency for programmable U / f
i P1.13	U / f mid point voltage	0,00	P1.11	%	100,00	605	Mid point voltage for programmable U / f as % of U _{nmot}
i P1.14	Zero freq voltage	0,00	40,00	%	Varies	606	Voltage at 0 Hz as % of U _{nmot}
i P1.15	Torque Boost	0	1		0	109	0 = Disabled 1 = Enabled
i P1.16	Switching frequency	1,5	16,0	kHz	4,0 / 2,0	601	PWM frequency. If values are higher than default, reduce the current capacity

Table 8.2: Motor settings

	Code	Parameter	Min	Max	Unit	Default	ID	Note
i	P1.17	Brake Chopper	0	2		0	504	0 = Disabled 1 = Enabled: Always 2 = Run state
	P1.18	Brake chopper level	0	911	V	varies	1267	Brake chopper control activation level in volt. For 240V Supply: $240 \times 1.35 \times 1.18 = 382V$ For 400V Supply: $400 \times 1.35 \times 1.18 = 638V$ Please note that when brake chopper is used the overvoltage controller can be switched off or the overvoltage reference level can be set above the brake chopper level.
i	P1.19	Motor identification	0	2		0	631	0 = Not active 1 = Standstill identification (need run command within 20 s to activate) 2 = Identification with run (need run command within 20 s to activate. Only available in power SW V026 included in FW01070V010 or later version)
	P1.20	Rs voltage drop	0,00	100,00	%	0,00	662	Voltage drop over motor windings as % of U_{nmot} at nominal current.
i	P1.21	Overvoltage controller	0	2		1	607	0 = Disabled 1 = Enabled, Standard mode 2 = Enabled, Shock load mode
i	P1.22	Undervoltage controller	0	1		1	608	0 = Disable 1 = Enable
	P1.23	Sine filter	0	1		0	522	0 = Not in use 1 = In use

Table 8.2: Motor settings

Code	Parameter	Min	Max	Unit	Default	ID	Note
P1.24	Modulator type	0	65535		28928	648	Modulator configuration word: B1 = Discontinuous modulation (DPWMMIN) B2 = Pulse dropping in overmodulation B6 = Under modulation B8 = Instantaneous DC voltage compensation * B11 = Low noise B12 = Dead time compensation * B13 = Flux error compensation * * Enabled by default
i P1.25	Efficiency optimization*	0	1		0	666	Energy optimization, the frequency converter search for the minimum cuuren in order to save energy and lower motor noise 0 = disabled 1 = enable
i P1.26	I/f start enable*	0	1		0	534	0 = disabled 1 = enable
i P1.27	I/f start frequency reference limit*	1	100	%	10	535	Output frequency limit below which the defined I/f start current is fed to motor.
i P1.28	I/f start current reference*	0	100.0	%	80.0	536	Current reference in percent of motor nominal current [1 = 0.1%]
i P1.29	Voltage limiter enable*	0	1		1	1079	Select voltage limiter mode: 0 = Disabled 1 = Enabled
P1.30	Start delay time	0	16.00	s	0	1499	NOTE! The delay time between run request is given and drive go to running. 0 = not used

Table 8.2: Motor settings

NOTE!

* These parameters are only available in power SW FWP00001V026 included in FW01070V010 or later version.

NOTE! These parameters are shown, when **P17.2 = 0**.

8.3 Start / stop setup (Control panel: Menu PAR -> P2)







Code	Parameter	Min	Max	Unit	Default	ID	Note
 P2.1	Remote Control Place Selection	0	2		0	172	0 = I / O terminals 1 = Fieldbus 2 = Keypad
 P2.2	Start function	0	1		0	505	0 = Ramp 1 = Flying start
 P2.3	Stop function	0	1		0	506	0 = Coasting 1 = Ramp
 P2.4	I / O Start / Stop logic	0	4		2	300	I / O control signal 1 I / O control signal 2 0 Forward Reverse 1 Fwd(edge) Inverted Stop 2 Fwd(edge) Bwd(edge) 3 Start Reverse 4 Start(edge) Reverse
 P2.5	Local / Remote	0	1		0	211	0 = Remote control 1 = Local control
P2.6	Keypad control direction	0	1		0	123	0 = Forward 1 = Reverse
P2.7	Keypad stop button	0	1		1	114	0 = Keypad control only 1 = Always
P2.8	Remote Control Place 2 Selection	0	2		0	173	0 = I / O terminals 1 = Fieldbus 2 = Keypad
 P2.9	keypad button lock	0	1		0	15520	0 = unlock all keypad button 1 = Loc/Rem button locked

Table 8.3: Start / stop setup

8.4 Frequency references (Control panel: Menu PAR -> P3)

Code	Parameter	Min	Max	Unit	Default	ID	Note
P3.1	Min frequency	0,00	P3.2	Hz	0,00	101	Minimum allowed frequency reference
P3.2	Max frequency	P3.1	320,00	Hz	50,00 / 60,00	102	Maximum allowed frequency reference
P3.3	Remote Control Place 1 frequency reference selection	1	Varies		7	117	1 = Preset speed 0 2 = Keypad 3 = Fieldbus 4 = AI1 5 = AI2 6 = PID 7 = AI1+ AI2 8 = Motor potentiometer 9 = Pulse train / Encoder 10 = AIE1 11 = Temperature input 1 12 = Temperature input 2 13 = Temperature input 3 Note: Pay attention to DI/Encoder switch position when set with 9 = Pulse train / Encoder
P3.4	Preset speed 0	P3.1	P3.2	Hz	5,00	180	Preset speed 0 is used as frequency reference when P3.3 = 1
P3.5	Preset speed 1	P3.1	P3.2	Hz	10,00	105	Activated by digital inputs
P3.6	Preset speed 2	P3.1	P3.2	Hz	15,00	106	Activated by digital inputs
P3.7	Preset speed 3	P3.1	P3.2	Hz	20,00	126	Activated by digital inputs
P3.8	Preset speed 4	P3.1	P3.2	Hz	25,00	127	Activated by digital inputs
P3.9	Preset speed 5	P3.1	P3.2	Hz	30,00	128	Activated by digital inputs
P3.10	Preset speed 6	P3.1	P3.2	Hz	40,00	129	Activated by digital inputs
P3.11	Preset speed 7	P3.1	P3.2	Hz	50,00	130	Activated by digital inputs
P3.12	Remote Control Place 2 frequency reference selection	1	Varies		5	131	As parameter P3.3
P3.13	Motor Potentionmeter Ramp	1	50	Hz/s	5	331	Speed variation rate
P3.14	Motor Potentionmeter Reset	0	2		2	367	0 = No Reset 1 = Reset if stopped 2 = Reset if powered down

Table 8.4: Frequency references

NOTE! These parameters are shown, when P17.2 = 0.

8.5 Ramps and brakes setup (Control panel: Menu PAR -> P4)

Code	Parameter	Min	Max	Unit	Default	ID	Note
i P4.1	Ramp S-shape 1	0,0	10,0	s	0,0	500	0 = Linear >0 = S-curve ramp time
P4.2	Acceleration time 1	0,1	3000,0	s	3,0	103	Defines the time required for the output frequency to increase from zero frequency to maximum frequency.
P4.3	Deceleration time 1	0,1	3000,0	s	3,0	104	Defines the time required for the output frequency to decrease from maximum frequency to zero frequency.
P4.4	Ramp S-shape 2	0,0	10,0	s	0,0	501	See the parameter P4.1
P4.5	Acceleration time 2	0,1	3000,0	s	10,0	502	See the parameter P4.2
i P4.6	Deceleration time 2	0,1	3000,0	s	10,0	503	See the parameter P4.3
i P4.7	Flux Braking	0	3		0	520	0 = Off 1 = Deceleration 2 = Chopper 3 = Full Mode
P4.8	Flux Braking Current	0,5 x I_{Nunit}	2,0 x I_{Nunit}	A	I_{Nunit}	519	Defines the current level for flux braking.
P4.9	DC Braking Current	0,3 x I_{Nunit}	2,0 x I_{Nunit}	A	I_{Nunit}	507	Defines the current injected into the motor during DC braking.
i P4.10	Stop DC current time	0,00	600,00	s	0,00	508	Determines if braking is ON or OFF and the braking time of the DC-brake when the motor is stopping. 0 = Not active
i P4.11	Stop DC current frequency	0,10	10,00	Hz	1,50	515	The output frequency at which the DC-braking is applied.
i P4.12	Start DC current time	0,00	600,00	s	0,00	516	0 = Not active

Table 8.5: Ramps and brakes setup

Code	Parameter	Min	Max	Unit	Default	ID	Note
P4.13	Accel2 Frequency Threshold	0.00	P3.2	Hz	0,00	527	0,00 = disabled
P4.14	Decel2 Frequency Threshold	0,00	P3.2	Hz	0,00	528	0,00 = disabled
P4.15	External Brake: Open Delay	0,00	320,00	s	0,20	1544	Delay to open brake after Open frequency limit is reached
P4.16	External Brake: Open Frequency limit	0,00	P3.2	Hz	1,50	1535	Opening frequency from forward and reverse direction.
P4.17	External Brake : Close Frequency limit	0,00	P3.2	Hz	1,00	1539	Close frequency from positive direction if no run command active.
P4.18	External Brake : Close Frequency limit in Reverse	0,00	P3.2	Hz	1,50	1540	Close frequency from negative direction if no run command active.
 P4.19	External Brake : Open/Close Current limit	0,0	200,0	%	20,0	1585	The brake is not opened if the current does not exceed this value, and is closed immediately if current goes below. This parameter is set as a percent of Motor nominal current.

Table 8.5: Ramps and brakes setup

8.6 Digital inputs (Control panel: Menu PAR -> P5)





Code	Parameter	Min	Max	Unit	Default	ID	Note
P5.1	I / O control signal 1	0	Varies		1	403	0 = Not used 1 = DI1 2 = DI2 3 = DI3 4 = DI4 5 = DI5 6 = DI6 7 = DIE1 8 = DIE2 9 = DIE3 10 = DIE4 11 = DIE5 12 = DIE6
 P5.2	I / O control signal 2	0	Varies		2	404	As parameter 5.1
 P5.3	Reverse	0	Varies		0	412	As parameter 5.1
P5.4	Ext. fault Close	0	Varies		6	405	As parameter 5.1
P5.5	Ext. fault Open	0	Varies		0	406	As parameter 5.1
P5.6	Fault reset	0	Varies		3	414	As parameter 5.1
P5.7	Run enable	0	Varies		0	407	As parameter 5.1
P5.8	Preset speed B0	0	Varies		4	419	As parameter 5.1
P5.9	Preset speed B1	0	Varies		5	420	As parameter 5.1
P5.10	Preset speed B2	0	Varies		0	421	As parameter 5.1
 P5.11	Ramp time 2 selection	0	Varies		0	408	As parameter 5.1
P5.12	Motor potentiometer up	0	Varies		0	418	As parameter 5.1
P5.13	Motor potentiometer down	0	Varies		0	417	As parameter 5.1
P5.14	Remote control place 2	0	Varies		0	425	Activates control place 2 As parameter 5.1
P5.15	Remote control place freq reference 2	0	Varies		0	343	Activates control place 2 See parameter 5.1
 P5.16	PID setpoint 2	0	Varies		0	1047	Activates reference 2 As parameter 5.1
 P5.17	Motor PreHeat Active	0	Varies		0	1044	Activates the Motor Pre-Heat (DC-Current) in stop state when parameter Motor Preheat function is set to 2 As parameter 5.1

Table 8.6: Digital inputs

8.7 Analogue inputs (Control panel: Menu PAR -> P6)



Code	Parameter	Min	Max	Unit	Default	ID	Note
P6.1	AI1 Signal range	0	1		0	379	0 = 0 - 100% (0 - 10 V) 1 = 20% - 100% (2 - 10 V)
P6.2	AI1 Custom min	-100,00	100,00	%	0,00	380	0,00 = no min scaling
P6.3	AI1 Custom max	-100,00	300,00	%	100,00	381	100,00 = no max scaling
P6.4	AI1 filter time	0,0	10,0	s	0,1	378	0 = no filtering
P6.5	AI2 signal range	0	1		0	390	As parameter P6.1
P6.6	AI2 Custom min	-100,00	100,00	%	0,00	391	As parameter P6.2
 P6.7	AI2 Custom max	-100,00	300,00	%	100,00	392	As parameter P6.3
 P6.8	AI2 filter time	0,0	10,0	s	0,1	389	As parameter P6.4
P6.9	AIE1 Signal range	0	1		0	143	As parameter P6.1, hidden until an option board is connected
P6.10	AIE1 Custom Min	-100,00	100,00	%	0,00	144	As parameter P6.2, hidden until an option board is connected
P6.11	AIE1 Custom Max	-100,00	300,00	%	100,00	145	As parameter P6.3, hidden until an option board is connected
P6.12	AIE1 Filter time	0,0	10,0	s	0,1	142	As parameter P6.4, hidden until an option board is connected

Table 8.7: Analogue inputs

8.8 Pulse train / Encoder (Control panel: Menu PAR -> P7)



Code	Parameter	Min	Max	Unit	Default	ID	Note
P7.1	Min pulse frequency	0	10000	Hz	0	1229	Pulse frequency to be interpreted as a 0% signal.
 P7.2	Max pulse frequency	0,0	10000	Hz	10000	1230	Pulse frequency to be interpreted as a 100% signal.
P7.3	Freq. ref. at min pulse freq.	0,00	P3.2	Hz	0,00	1231	Frequency corresponding to 0% if used as frequency reference.
 P7.4	Freq. ref. at max pulse freq.	0,00	P3.2	Hz	50,00 / 60,00	1232	Frequency corresponding to 100% if used as frequency reference.

Table 8.8: Pulse train/Encoder



Code	Parameter	Min	Max	Unit	Default	ID	Note
 P7.5	Encoder direction	0	2		0	1233	0 = Disable 1 = Enable / Normal 2 = Enable / Inverted
 P7.6	Encoder pulses / revolution	1	65535	ppr	256	629	Pulse count of encoder per round. Used for scaling encoder rpm monitor value only.
 P7.7	Config DI5 and DI6	0	2		0	1165	0 = DI5 and DI6 are for normal digital input 1 = DI6 is for pulse train 2 = DI5 and DI6 are for encoder frequency mode

Table 8.8: Pulse train/Encoder

8.9 Digital outputs (Control panel: Menu PAR -> P8)

Code	Parameter	Min	Max	Unit	Default	ID	Selections
P8.1	R01 signal selection	0	Varies		2	313	0 = Not used 1 = Ready 2 = Run 3 = Fault 4 = Fault Inverted 5 = Warning 6 = Reversed 7 = At Speed 8 = Motor regulator active 9 = FB Control Word.B13 10 = FB Control Word.B14 11 = FB Control Word.B15 12 = Output freq superv. 13 = Output torque superv. 14 = Unit temperature superv. 15 = Analogue input superv. 16 = Preset Speed Active 17 = External Brake ctrl 18 = Keypad control active 19 = I / O control active 20 = Temperature supervision
P8.2	R02 signal selection	0	Varies		3	314	As parameter 8.1
 P8.3	DO1 signal selection	0	Varies		1	312	As parameter 8.1

Table 8.9: Digital outputs

Code	Parameter	Min	Max	Unit	Default	ID	Selections
P8.4	RO2 inversion	0	1		0	1588	0 = No inversion 1 = Inverted
P8.5	RO2 ON delay	0,00	320,00	s	0,00	460	0,00 = No delay
P8.6	RO2 OFF delay	0,00	320,00	s	0,00	461	0,00 = No delay
P8.7	RO1 inversion	0	1		0	1587	0 = No inversion 1 = Inverted
P8.8	RO1 ON delay	0,00	320,00	s	0,00	458	0,00 = No delay
P8.9	RO1 OFF delay	0,00	320,00	s	0,00	459	0,00 = No delay
P8.10	DOE1 signal selection	0	Varies		0	317	As parameter 8.1, hidden until an option board is connected
P8.11	DOE2 signal selection	0	Varies		0	318	As parameter 8.1, hidden until an option board is connected
P8.12	DOE3 signal selection	0	Varies		0	1386	As parameter 8.1, hidden until an option board is connected
P8.13	DOE4 signal selection	0	Varies		0	1390	As parameter 8.1, hidden until an option board is connected
P8.14	DOE5 signal selection	0	Varies		0	1391	As parameter 8.1, hidden until an option board is connected
P8.15	DOE6 signal selection	0	Varies		0	1395	As parameter 8.1, hidden until an option board is connected

Table 8.9: Digital outputs

8.10 Analogue outputs (Control panel: Menu PAR -> P9)

Code	Parameter	Min	Max	Unit	Default	ID	Selections
i P9.1	Analog output signal selection	0	14		1	307	0 = Not used 1 = Output freq. (0- f_{max}) 2 = Output current (0- I_{nMotor}) 3 = Motor torque (0- T_{nMotor}) 4 = PID output (0 - 100%) 5 = Freq. refer. (0- f_{max}) 6 = Motor speed (0- n_{max}) 7 = Motor power (0- P_{nMotor}) 8 = Motor Voltage (0- U_{nMotor}) 9 = DC-link Voltage (0 - 1000 V) 10 = Process Data In1 (0 - 10000) 11 = Process Data In2 (0 - 10000) 12 = Process Data In3 (0 - 10000) 13 = Process Data In4 (0 - 10000) 14 = Test 100%
i P9.2	Analog output minimum	0	1		0	310	0 = 0 V / 0 mA 1 = 2 V / 4 mA
P9.3	Analog output scaling	0,0	1000,0	%	100,0	311	Scaling factor
P9.4	Analog output filter time	0,00	10,00	s	0,10	308	Filter time
P9.5	Analog output E1 signal selection	0	14		0	472	As parameter P9.1, hidden until an option board is connected
P9.6	Analog output E1 minimum	0	1		0	475	As parameter P9.2, hidden until an option board is connected
P9.7	Analog output E1 scaling	0,0	1000,0	%	100,0	476	As parameter P9.3, hidden until an option board is connected
P9.8	Analog output E1 filter time	0,00	10,00	s	0,10	473	As parameter P9.4, hidden until an option board is connected

Table 8.10: Analogue outputs

Code	Parameter	Min	Max	Unit	Default	ID	Selections
P9.9	Analog output E2 signal selection	0	14		0	479	As parameter P9.1, hidden until an option board is connected
P9.10	Analog output E2 minimum	0	1		0	482	As parameter P9.2, hidden until an option board is connected
P9.11	Analog output E2 scaling	0,0	1000,0	%	100,0	483	As parameter P9.3, hidden until an option board is connected
P9.12	Analog output E2 filter time	0,00	10,00	s	0,10	480	As parameter P9.4, hidden until an option board is connected

Table 8.10: Analogue outputs

8.11 Fieldbus Data-Mapping (Control panel: Menu PAR -> P10)

Code	Parameter	Min	Max	Unit	Default	ID	Note
 P10.1	FB Data Output 1 selection	0	Varies		0	852	<ul style="list-style-type: none"> 0 = Frequency reference 1 = Output reference 2 = Motor speed 3 = Motor current 4 = Motor voltage 5 = Motor torque 6 = Motor power 7 = DC link voltage 8 = Active fault code 9 = Analogue AI1 10 = Analogue AI2 11 = Digital input state 12 = PID feedback value 13 = PID setpoint 14 = Pulse train / encoder input [%] 15 = Pulse train / encoder pulse[] 16 = AIE1
P10.2	FB Data Output 2 selection	0	Varies		1	853	Variable mapped on PD2
P10.3	FB Data Output 3 selection	0	Varies		2	854	Variable mapped on PD3
P10.4	FB Data Output 4 selection	0	Varies		4	855	Variable mapped on PD4

Table 8.11: Fieldbus Data-Mapping

Code	Parameter	Min	Max	Unit	Default	ID	Note
P10.5	FB Data Output 5 selection	0	Varies		5	856	Variable mapped on PD5
P10.6	FB Data Output 6 selection	0	Varies		3	857	Variable mapped on PD6
P10.7	FB Data Output 7 selection	0	Varies		6	858	Variable mapped on PD7
P10.8	FB Data Output 8 selection	0	Varies		7	859	Variable mapped on PD8
 P10.9	Aux CW Data In selection	0	5		0	1167	PDI for Aux CW 0 = Not used 1 = PDI1 2 = PDI2 3 = PDI3 4 = PDI4 5 = PDI5

Table 8.11: Fieldbus Data-Mapping

8.12 Prohibited Frequencies (Control panel: Menu PAR -> P11)

Code	Parameter	Min	Max	Unit	Default	ID	Note
P11.1	Prohibit Frequency Range 1 Low Limit	0,00	P3.2	Hz	0,00	509	Low Limit 0 = Not used
P11.2	Prohibit Frequency Range 1 High Limit	0,00	P3.2	Hz	0,00	510	High Limit 0 = Not used
P11.3	Prohibit Frequency Range 2 Low Limit	0,00	P3.2	Hz	0,00	511	Low Limit 0 = Not used
 P11.4	Prohibit Frequency Range 2 High Limit	0,00	P3.2	Hz	0,00	512	High Limit 0 = Not used

Table 8.12: Prohibited Frequencies

8.13 Limit Supervisions (Control panel: Menu PAR -> P12)

Code	Parameter	Min	Max	Unit	Default	ID	Note
P12.1	Output freq. supervision function	0	2		0	315	0 = Not used 1 = Low limit 2 = High limit
P12.2	Output freq. supervision limit	0,00	P3.2	Hz	0,00	316	Output frequency supervision threshold
P12.3	Torque supervision function	0	2		0	348	0 = Not used 1 = Low limit 2 = High limit
P12.4	Torque supervision limit	0,0	300,0	%	0,0	349	Torque supervision Threshold
P12.5	Unit Temperature Supervision	0	2		0	354	0 = Not used 1 = Low limit 2 = High limit
P12.6	Unit Temperature Supervision Limit	-10	100	°C	40	355	Unit temperature supervision threshold
P12.7	Analogue input superv signal	0	Varies		0	356	0 = AI1 1 = AI2 2 = AIE1
P12.8	AI superv ON level	0,00	100,00	%	80,00	357	ON threshold AI superv.
P12.9	AI superv OFF level	0,00	100,00	%	40,00	358	OFF threshold AI superv.
P12.10	Temperature supervision input	1	7		1	1431	Binary-coded selection of signals to use for temperature supervision B0 = Temperature input 1 B1 = Temperature input 2 B2 = Temperature input 3 NOTE! Hidden until an option board is connected
P12.11	Temperature supervision function	0	2		2	1432	As parameter 12.1, hidden until an option board is connected
P12.12	Temperature supervision limit	-50,0/ 223,2	200,0/ 473,2		80,0	1433	Temperature supervision threshold, hidden until an option board is connected

Table 8.13: Limit Supervisions

8.14 Protections (Control panel: Menu PAR -> P13)









Code	Parameter	Min	Max	Unit	Default	ID	Note
P13.1	Analog Input low fault	0	4		1	700	0 = No action 1 = Alarm 2 = Alarm, preset alarm frequency 3 = Fault: Stop function 4 = Fault: Coast
P13.2	Under voltage fault	1	2		2	727	1 = No response (no fault generated but drive still stops modulation) 2 = Fault:Coast
P13.3	Earth fault	0	3		2	703	0 = No action 1 = Alarm 2 = Fault:Stop function 3 = Fault:Coast
P13.4	Output Phase Fault	0	3		2	702	As parameter 13.3
 P13.5	Stall protection	0	3		0	709	As parameter 13.3
 P13.6	Under load protection	0	3		0	713	As parameter 13.3
 P13.7	Motor thermal protection	0	3		2	704	As parameter 13.3
 P13.8	Mtp:Ambient temperature	-20	100	°C	40	705	Environment temperature
 P13.9	Mtp:Zero speed cooling	0,0	150,0	%	40,0	706	Cooling as % at 0 speed
 P13.10	Mtp:Thermal time constant	1	200	min	Varies	707	Motor thermal time constant
 P13.11	Stall Current	0,00	2,0 x I _{Nunit}	A	I _{Nunit}	710	For a stall stage to occur, the current must have exceeded this limit
 P13.12	Stall time	0,00	300,00	s	15,00	711	Stall time limited
P13.13	Stall frequency	0,10	320,00	Hz	25,00	712	Stall min. frequency
 P13.14	UL:Field weakening load	10,0	150,0	%	50,0	714	Minimum torque at field weakening
P13.15	UL:Zero freq load	5,0	150,0	%	10,0	715	Minimum torque at f0

Table 8.14: Protections

Code	Parameter	Min	Max	Unit	Default	ID	Note
P13.16	UL:Time limit	1,0	300,0	s	20,0	716	This is the maximum time allowed for an underload state to exist
P13.17	Analog Input low fault delay	0,0	10,0	s	0,5	1430	Delay time for analog input low fault
P13.18	External fault	0	3		2	701	Same as parameter 13.3
P13.19	Fieldbus fault	0	4		3	733	As parameter 13.1
P13.20	Preset alarm frequency	P3.1	P3.2	Hz	25,00	183	Frequency used when fault response is Alarm + preset Frequency.
P13.21	Parameters edit lock	0	1		0	819	0 = Edit enabled 1 = Edit disabled
P13.22	Thermistor Fault	0	3		2	732	0 = No action 1 = Alarm 2 = Fault: Stop function 3 = Fault: Coast Hidden until an option board is connected.
P13.23	FWD/REV conflict supervision	0	3		1	1463	Same as P13.3
P13.24	Temperature fault	0	3		0	740	As parameter P13.3, hidden until an OPTBH board is connected
P13.25	Temperature fault input	1	7		1	739	Binary-coded selection of signals to use for alarm and fault triggering B0 = Temperature input 1 B1 = Temperature input 2 B2 = Temperature input 3 NOTE! Hidden until an OPTBH board is connected
P13.26	Temperature fault mode	0	2		2	743	0 = Not used 1 = Low limit 2 = High limit
P13.27	Temperature fault limit	-50,0/ 223,2	200,0/ 473,2		100,0	742	Temperature fault threshold, hidden until an OPTBH board is connected

Table 8.14: Protections

Code	Parameter	Min	Max	Unit	Default	ID	Note
P13.28	Input phase fault*	0	3		3	730	As parameter P13.3
P13.29	Motor temperature memory mode*	0	2		2	15521	0 = disabled 1 = constant mode 2 = last value mode

Table 8.14: Protections

NOTE!

* These parameters are only available in power SW FWP00001V026 included in FW01070V010 or later versiond.

NOTE! These parameters are shown, when **P17.2 = 0**.

8.15 Fault autoreset parameters (Control panel: Menu PAR -> P14)

Code	Parameter	Min	Max	Unit	Default	ID	Note
P14.1	Automatic Reset	0	1		0	731	0 = Disabled 1 = Enable
P14.2	Wait time	0,10	10,00	s	0,50	717	Waiting time after fault
P14.3	Trial time	0,00	60,00	s	30,00	718	Maximum time for trials
P14.4	Trials number	1	10		3	759	Maximum trials
P14.5	Restart Function	0	2		2	719	0 = Ramping 1 = Flying 2 = From Start Function

Table 8.15: Fault autoreset parameters

NOTE! These parameters are shown, when **P17.2 = 0**.

8.16 PID control parameters (Control panel: Menu PAR -> P15)

Code	Parameter	Min	Max	Unit	Default	ID	Note
P15.1	Setpoint source selection	0	Varies		0	332	0 = Fixed setpoint % 1 = AI1 2 = AI2 3 = ProcessDataIn1 (0 -100%) 4 = ProcessDataIn2 (0 -100%) 5 = ProcessDataIn3 (0 -100%) 6 = ProcessDataIn4 (0 -100%) 7 = Pulse train/encoder 8 = AIE1 9 = Temperature input 1 10 = Temperature input 2 11 = Temperature input 3
P15.2	Fixed setpoint	0,0	100,0	%	50,0	167	Fixed setpoint
P15.3	Fixed setpoint 2	0,0	100,0	%	50,0	168	Alternative fixed setpoint, selectable with DI
P15.4	Feedback source selection	0	Varies		1	334	0 = AI1 1 = AI2 2 = ProcessDataIn1 (0 -100%) 3 = ProcessDataIn2 (0 -100%) 4 = ProcessDataIn3 (0 -100%) 5 = ProcessDataIn4 (0 -100%) 6 = AI2-AI1 7 = Pulse train / encoder 8 = AIE1 9 = Temperature input 1 10 = Temperature input 2 11 = Temperature input 3
P15.5	Feedback value minimum	0,0	50,0	%	0,0	336	Value at minimum signal
P15.6	Feedback value maximum	10,0	300,0	%	100,0	337	Value at maximum signal
P15.7	P gain	0,0	1000,0	%	100,0	118	Proportional gain

Table 8.16: PID control parameters

	Code	Parameter	Min	Max	Unit	Default	ID	Note
i	P15.8	I time	0,00	320,00	s	10,00	119	Integrative time
i	P15.9	D time	0,00	10,00	s	0,00	132	Derivative time
	P15.10	Error inversion	0	1		0	340	0 = Direct (Feedback < Setpoint -> Increase PID output) 1 = Inverted (Feedback > Setpoint -> Decrease PID output)
	P15.11	Sleep minimum frequency	0,00	P3.2	Hz	25,00	1016	Drive goes to sleep mode when the output frequency stays below this limit for a time greater than that defined by parameter Sleep delay
	P15.12	Sleep delay	0	3600	s	30	1017	Delay for enter sleep
i	P15.13	Wake up error	0,0	100,0	%	5,0	1018	Threshold for exit sleep
	P15.14	Sleep setpoint boost	0,0	50,0	%	10,0	1071	Referred to setpoint
	P15.15	Setpoint boost time	0	60	s	10	1072	Boost time after P15.12
	P15.16	Sleep maximum loss	0,0	50,0	%	5,0	1509	Referred to feedback value after boost
i	P15.17	Sleep loss check time	1	300	s	30	1510	After boost time P15.15
i	P15.18	Process unit source select	0	6		0	1513	0 = PID feedback value 1 = Output frequency 2 = Motor speed 3 = Motor torque 4 = Motor power 5 = Motor current 6 = Pulse Train / Encoder
i	P15.19	Process unit decimal digits	0	3		1	1035	Decimals on display
i	P15.20	Process unit minimum value	0,0	P15,21		0,0	1033	Process min value
i	P15.21	Process unit maximum value	P15.20	3200,0		100,0	1034	Process max value

Table 8.16: PID control parameters

Code	Parameter	Min	Max	Unit	Default	ID	Note
P15.22	Temperature min value	-50,0/ 223,2	P15.23		0,0	1706	Temperature min value for PID and frequency reference scale, hidden until an OPTBH board is connected
P15.23	Temperature max value	P15.22	200,0/ 473,2		100,0	1707	Temperature max value for PID and frequency reference scale, hidden until an OPTBH board is connected

Table 8.16: PID control parameters

NOTE! These parameters are shown, when **P17.2 = 0**.

8.17 Motor Pre-heat (Control panel: Menu PAR -> P16)

Code	Parameter	Min	Max	Unit	Default	ID	Note
P16.1	Motor Pre-heat Function	0	2		0	1225	0 = Not used 1 = Always in stop state 2 = Controlled by digital input
P16.2	Motor Pre-heat Current	0	0,5 x I _{Nunit}	A	0	1227	DC current for Pre-heating of motor and drive in stop state. Active in stop state or by digital input while in stop state.

Table 8.17: Motor Pre-heat

8.18 Easy usage menu (Control panel: Menu PAR -> P17)



Code	Parameter	Min	Max	Unit	Default	ID	Note
 P17.1	Application Type	0	3		0	540	0 = Basic 1 = Pump 2 = Fan drive 3 = High Torque NOTE! Visible only when Startup wizard is active.
P17.2	Parameter conceal	0	1		1	115	0 = All parameters visible 1 = Only quick setup parameter group visible
P17.3	Temperature unit	0	1		0	1197	0 = Celsius 1 = Kelvins NOTE! Hidden until an OPTBH board is connected.
 P17.4	Application access password*	0	30000		0	2362	Input the right password could review parameter group 18.

Table 8.18: Easy usage menu parameters

NOTE!

* These parameters are only available in power SW FWP00001V026 included in FW01070V010 or later version.

8.19 System parameters

Code	Parameter	Min	Max	Default	ID	Note
Software information (MENU SYS->V1)						
V1.1	API SW ID				2314	
V1.2	API SW version				835	
V1.3	Power SW ID				2315	
V1.4	Power SW version				834	
V1.5	Application ID				837	
V1.6	Application revision				838	
V1.7	System load				839	
When no field bus Option Board or no OPT-BH Board has been installed, the Modbus comm. Parameters are as follows						
V2.1	Communication status				808	Status of Modbus communication. Format: xx.yyy where xx = 0 - 64 (Number of error messages) yyy = 0 - 999 (Number of good messages)
P2.2	Fieldbus protocol	0	1	0	809	0 = Not used 1 = Modbus used
P2.3	Slave address	1	255	1	810	
P2.4	Baud rate	0	8	5	811	0 = 300 1 = 600 2 = 1200 3 = 2400 4 = 4800 5 = 9600 6 = 19200 7 = 38400 8 = 57600
P2.6	Parity type	0	2	0	813	0 = None 1 = Even 2 = Odd The Stop Bit is 2-bit When Parity type is 0 = None; The Stop Bit is 1-bit When Parity type is 1 = Even or 2 = Odd

Table 8.19: System parameters

Code	Parameter	Min	Max	Default	ID	Note
P2.7	Communication time out	0	255	10	814	0 = Not used 1 = 1 sec 2 = 2 secs, etc
P2.8	Reset communication status	0	1	0	815	
When Canopen E6 board has been installed, the comm. Parameters are as follows						
V2.1	Canopen communication status				14004	0 = Initialising 4 = Stopped 5 = Operational 6 = Pre_Operational 7 = Reset_Application 8 = Reset_Comm 9 = Unknow
P2.2	Canopen operation mode	1	2	1	14003	1 = Driver Profile 2 = Bypass
P2.3	Canopen Node ID	1	127	1	14001	
P2.4	Canopen baud rate	3	8	6	14002	3 = 50 kBaud 4 = 100 kBaud 5 = 125 kBaud 6 = 250 kBaud 7 = 500 kBaud 8 = 1000 kBaud
When DeviceNet E7 board has been installed, the comm. Parameters are as follows						
V2.1	Communication status				14014	Status of Modbus communication. Format: XXXX.Y , X = DeviceNet msg counter, Y = DeviceNet status. 0 = Non-existent or no bus power. 1 = Configuring state 2 = Established 3 = Timeout
P2.2	Output assembly type	20	111	21	14012	20, 21, 23, 25, 101, 111
P2.3	MAC ID	0	63	63	14010	
P2.4	Baud rate	1	3	1	14011	1 = 125 kbit/s 2 = 250 kbit/s 3 = 500 kbit/s
P2.5	Input assembly type	70	117	71	14013	70, 71, 73, 75, 107, 117

Table 8.19: System parameters

Code	Parameter	Min	Max	Default	ID	Note
When ProfidBus E3/E5 board has been installed, the comm. Parameters are as follows						
V2.1	Communication status				14022	
V2.2	Fieldbus protocol status				14023	
V2.3	Active protocol				14024	
V2.4	Active buad rate				14025	
V2.5	Telegram type				14027	
P2.6	Operate mode	1	3	1	14021	1 = Profidrive 2 = Bypass 3 = Echo
P2.7	Slave address	2	126	126	14020	
When ModbusTCP & ProfinetIO E9 board has been installed, the comm.Parameters are as follows						
V2.1	IP Part1	1	233		14232	current IP Address Part1
V2.2	IP Part2	0	255		14233	current IP Address Part2
V2.3	IP Part3	0	255		14234	current IP Address Part3
V2.4	IP Part4	0	255		14235	current IP Address Part4
V2.5	Subnet Mask P1	0	255		14236	current Subnet Mask Part1
V2.6	Subnet Mask P2	0	255		14237	current Subnet Mask Part2
V2.7	Subnet Mask P3	0	255		14238	current Subnet Mask Part3
V2.8	Subnet Mask P4	0	255		14239	current Subnet Mask Part4
V2.9	Default GW P1	0	255		14240	current Default Gate-way Part1
V2.10	Default GW P2	0	255		14241	current Default Gate-way Part2
V2.11	Default GW P3	0	255		14242	current Default Gate-way Part3
V2.12	Default GW P4	0	255		14243	current Default Gate-way Part4

Table 8.19: System parameters

Code	Parameter	Min	Max	Default	ID	Note
V2.13	FB Protocol Status "Initializing, Stopped, Operational, Faulted"				14244	
V2.14	Communication Status				14245	0-64 Number of messages with errors, 0-999 Number of messages without communication errors
V2.15	Drive control word				14246	Control word in drive format (hex)
V2.16	Drive Status word				14247	Status word in drive format (hex)
V2.17	Profile control word				14248	Control word in protocol format (hex)
V2.18	Profile status word				14249	Status word in protocol format (hex)
P2.19	Protocol	1	2	1	14230	Active Protocol. 1= ModbusTCP, 2= ProfinetIO
P2.20	IP Address Mode	1	2	2	14231	IP mode. 1=DHCP, 2=fixed. When in DHCP mode, the IP address cannot be changed manually
P2.21	IP Part1	1	223	192	14180	IP Address Part1
P2.22	IP Part2	0	255	168	14181	IP Address Part2
P2.23	IP Part3	0	255	0	14182	IP Address Part3
P2.24	IP Part4	0	255	10	14183	IP Address Part4
P2.25	Subnet Mask P1	0	255	255	14184	Subnet Mask Part 1
P2.26	Subnet Mask P2	0	255	255	14185	Subnet Mask Part 2
P2.27	Subnet Mask P3	0	255	0	14186	Subnet Mask Part 3
P2.28	Subnet Mask P4	0	255	0	14187	Subnet Mask Part 4
P2.29	Default GW P1	0	255	192	14188	Default Gateway Part1
P2.30	Default GW P2	0	255	168	14189	Default Gateway Part2
P2.31	Default GW P3	0	255	0	14190	Default Gateway Part3

Table 8.19: System parameters

Code	Parameter	Min	Max	Default	ID	Note
P2.32	Default GW P4	0	255	1	14191	Default Gateway Part4
P2.33	Comm.Timeout	0	65535	10	14200	Comm.Timeout
When OPT-BH board has been installed, the comm. Parameters are as follows						
P2.1	Sensor 1 type	0	6	0	14072	0 = No Sensor 1 = PT100 2 = PT1000 3 = Ni1000 4 = KTY84 5 = 2 x PT100 6 = 3 x PT100
P2.2	Sensor 2 type	0	6	0	14073	0 = No Sensor 1 = PT100 2 = PT1000 3 = Ni1000 4 = KTY84 5 = 2 x PT100 6 = 3 x PT100
P2.3	Sensor 3 type	0	6	0	14074	0 = No Sensor 1 = PT100 2 = PT1000 3 = Ni1000 4 = KTY84 5 = 2 x PT100 6 = 3 x PT100
When OPT-EC board has been installed, the comm. Parameters are as follows						
V2.1	version number			0		Version number of the board software
V2.2	Board status			0		State of the OPTEC board application

Table 8.19: System parameters

Code	Parameter	Min	Max	Default	ID	Note
Other information						
V3.1	MWh counter				827	Million Watt Hour
V3.2	Power on days				828	
V3.3	Power on hours				829	
V3.4	Run counter: Days				840	
V3.5	Run counter: Hours				841	
V3.6	Fault counter				842	
V3.7	Panel parameter set status monitor					Hidden when connect with PC.
P4.2	Restore factory defaults	0	1	0	831	1 = Restores factory defaults for all parameters
P4.3	Password	0000	9999	0000	832	
P4.4	Time for panel and lcd backlight active	0	99	5	833	NOTE! Backlight active time; [0->Off; 1-60->1-60min; >=61-> Always On]
P4.5	Save parameter set to panel	0	1	0		Hidden when connect with PC.
P4.6	Restore parameter set from panel	0	1	0		Hidden when connect with PC.
F5.x	Active Fault menu					
F6.x	Fault History menu					

Table 8.19: System parameters

9. PARAMETER DESCRIPTIONS

On the next pages you can find the descriptions of certain parameters. The descriptions have been arranged according to parameter group and number.

9.1 Motor settings (Control panel: Menu PAR -> P1)

1.7 CURRENT LIMIT

This parameter determines the maximum motor current from the frequency converter. To avoid motor overload, set this parameter according to the rated current of the motor. The current limit is equal to $(1.5 \times I_n)$ by default.

1.8 MOTOR CONTROL MODE

With this parameter the user can select the motor control mode. The selections are:

0 = Frequency control:

Drive frequency reference is set to output frequency without slip compensation. Motor actual speed is finally defined by motor load.

1 = Open loop speed control:

Drive frequency reference is set to motor speed reference. The motor speed remains the same regardless of motor load. Slip is compensated.

1.9 U / F RATIO

There are three selections for this parameter:

0 = Linear:

The voltage of the motor changes linearly with the frequency in the constant flux area from 0 Hz to the field weakening point where the field weakening point voltage is supplied to the motor. Linear U/f ratio should be used in constant torque applications. See Figure 9.1.

This default setting should be used if there is no special need for another setting.

1 = Square:

The voltage of the motor changes following a squared curve form with the frequency in the area from 0 Hz to the field weakening point where the field weakening point voltage is also supplied to the motor. The motor runs under magnetised below the field weakening point and produces less torque, power losses and electromechanical noise. Squared U/f ratio can be used in applications where torque demand of the load is proportional to the square of the speed, e.g. in centrifugal fans and pumps.

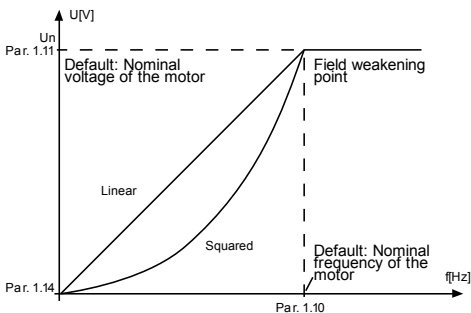

Figure 9.1: Linear and squared change of motor voltage

2 = Programmable U/f curve:

The U/f curve can be programmed with three different points. Programmable U/f curve can be used if the other settings do not satisfy the needs of the application.

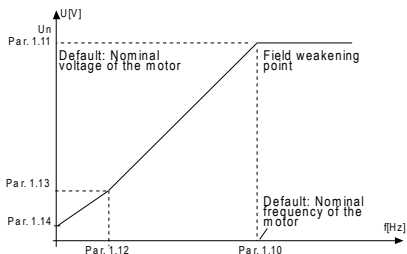

Figure 9.2: Programmable U / f curve

1.10 FIELD WEAKENING POINT

The field weakening point is the output frequency at which the output voltage reaches the value set with par. 1.11.

1.11 FIELD WEAKENING POINT VOLTAGE

Above the frequency at the field weakening point, the output voltage remains at the value set with this parameter. Below the frequency at the field weakening point, the output voltage depends on the setting of the U / f curve parameters. See parameters 1.9-1.14 and Figures 9.1 and 9.2.

When the parameters 1.1 and 1.2 (nominal voltage and nominal frequency of the motor) are set, the parameters 1.10 and 1.11 are automatically given the corresponding values. If you need different values for the field weakening point and the voltage, change these parameters after setting the parameters 1.1 and 1.2.

1.12 U / F MIDDLE POINT FREQUENCY

If the programmable U / f curve has been selected with the parameter 1.9, this parameter defines the middle point frequency of the curve. See Figure 9.2.

1.13 U / F MIDDLE POINT VOLTAGE

If the programmable U / f curve has been selected with the parameter 1.9, this parameter defines the middle point voltage of the curve. See Figure 9.2.

1.14 ZERO FREQUENCY VOLTAGE

This parameter defines the zero frequency voltage of the curve. See Figures 9.1 and 9.2.

1.15 TORQUE BOOST

When this parameter has been activated, the voltage to the motor changes automatically with high load torque which makes the motor produce sufficient torque to start and run at low frequencies. The voltage increase depends on the motor type and power. Automatic torque boost can be used in applications with high load torque, e.g. in conveyors.

0 = Disabled

1 = Enabled

Note: In high torque - low speed applications - it is likely that the motor will overheat. If the motor has to run a prolonged time under these conditions, special attention must be paid to cooling the motor. Use external cooling for the motor if the temperature tends to rise too high.

Note: The best performance can be reached by running motor identification, see par. 1.18.

1.16 SWITCHING FREQUENCY

Motor noise can be minimised using a high switching frequency. Increasing the switching frequency reduces the capacity of the frequency converter unit.

Switching frequency for Vacon 20: 1.5...16 kHz.

1.17 BRAKE CHOPPER

Note! An internal brake chopper is installed in three phase supply MI2 and MI3 size drives.

0 = Disable (No brake chopper used)

1 = Enable: Always (Used in Run and Stop state)

2 = Enable: Run state (Brake chopper used in Run state)

WHEN THE FREQUENCY CONVERTER IS DECELERATING THE MOTOR, THE ENERGY STORED TO THE INERTIA OF THE MOTOR AND THE LOAD ARE FED INTO AN EXTERNAL BRAKE RESISTOR, IF THE BRAKE CHOPPER HAS BEEN ACTIVATED. THIS ENABLES THE FREQUENCY CONVERTER TO DECELERATE THE LOAD WITH A TORQUE EQUAL TO THAT OF ACCELERATION (PROVIDED THAT THE CORRECT BRAKE RESISTOR HAS BEEN SELECTED). SEE SEPARATE BRAKE RESISTOR INSTALLATION MANUAL.

1.19 MOTOR IDENTIFICATION

0 = Not active

1 = Standstill identification

When Standstill identification is selected, the drive will perform an ID-run when it is started from selected control place. Drive has to be started within 20 seconds, otherwise identification is aborted.

The drive does not rotate the motor during Standstill identification. When ID run is ready the drive is stopped. Drive will start normally, when the next start command is given.

After end the identification, the drive need stop the start command. If control place is Keypad, user need press stop button. If control place is IO, user need put DI(Control signal) inactivate. If control place is fieldbus, user need set the control bit to 0.

The ID run improves the torque calculations and the automatic torque boost function. It will also result in a better slip compensation in speed control (more accurate RPM).

The parameters below will change after ID run successfully,

- a. P1.8 Motor control mode
- b. P1.9 U / f ratio
- c. P1.12 U / f mid point frequency
- d. P1.13 U / f mid point voltage
- e. P1.14 Zero freq voltage
- f. P1.19 Motor identification (1->0)
- g. P1.20 Rs voltage drop

Note!The nameplate data of the motor has to be set BEFORE doing ID run.

1.21 OVERVOLTAGE CONTROLLER

0 = Disabled

1 = Enabled, Standard mode (Minor adjustments of OP frequency are made)

2 = Enabled, Shock load mode (Controller adjusts OP freq. up to max.freq.)

1.22 UNDERVOLTAGE CONTROLLER

0 = Disable

1 = Enable

These parameters allow the under-/overvoltage controllers to be switched out of operation. This may be useful, for example, if the mains supply voltage varies more than -15% to +10% and the application will not tolerate this over-/undervoltage. In this case, the regulator controls the output frequency taking the supply fluctuations into account.

When a value other than 0 is selected also the Closed Loop overvoltage controller becomes active (in Multi-Purpose Control application).

Note: Over-/undervoltage trips may occur when controllers are switched out of operation.

1.25 EFFICIENCY OPTIMIZATION

Energy optimization, the frequency converter search for the minimum current in order to save energy and lower motor noise, **0** = disabled, **1** = enable.

1.26 I/F START ENABLE

The I/f Start function is typically used with permanent magnet motors (PM) to start the motor with constant current control. This is useful with high power motors in which the resistance is low and the tuning of the U/f curve difficult. Applying the I/f Start function may also prove useful in providing sufficient torque for the motor at startup.

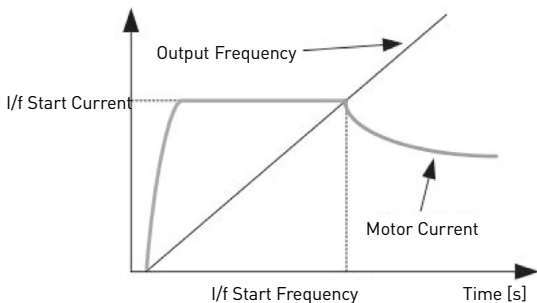

Figure 9.3: I/f Start

1.27 I/F START FREQUENCY REFERENCE LIMIT

Output frequency limit below which the defined I/f start current is fed to motor.

1.28 I/F START CURRENT REFERENCE

The current fed to the motor when the I/f start function is activated.

1.29 VOLTAGE LIMITER ENABLE

Voltage limiter function addresses problem with very high DC-link voltage ripple with 1-phase drives when fully loaded. Very high ripple in DC-link voltage will transform to high current and torque ripple, which can disturb some users. Voltage limiter function limits maximum output voltage to bottom of DC-voltage ripple. This reduces current and torque ripple, but decreases maximum output power since voltage is limited and more current is needed.

0 = disable, **1** = enable.

9.2 Start / stop setup (Control panel: Menu PAR -> P2)

2.1 REMOTE CONTROL PLACE SELECTION

With this parameter, the user can select the active control place, frequency converter can be selected with P3.3/P3.12. The selections are:

- 0 = I / O terminal
- 1 = Fieldbus
- 2 = Keypad

Note: You can select control place by pressing Loc / Rem button or with par. 2.5(Local / Remote), P2.1 will have no effect in local mode.

Local = Keyp ad is the control place

Remote = Control place determined by P2.1

2.2 START FUNCTION

The user can select two start functions for Vacon 20 with this parameter:

0 = Ramp start

The frequency converter starts from 0 Hz and accelerates to the set frequency reference within the set acceleration time (See detailed description: ID103). (Load inertia, torque or starting friction may cause prolonged acceleration times).

1 = Flying start

The frequency converter is able to start into a running motor by applying small current pulses to motor and searching for the frequency corresponding to the speed the motor is running at. Searching starts from the maximum frequency towards the actual frequency until the correct value is detected. Thereafter, the output frequency will be increased/decreased to the set reference value according to the set acceleration/deceleration parameters.

Use this mode if the motor is coasting when the start command is given. With the flying start it is possible to start the motor from actual speed without forcing the speed to zero before ramping to reference.

2.3 STOP FUNCTION

Two stop functions can be selected in this application:

0 = Coasting

The motor coasts to a halt without control from the frequency converter after the Stop command.

1 = Ramping

After the Stop command, the speed of the motor is decelerated according to the set deceleration parameters.

If the regenerated energy is high it may be necessary to use an external braking resistor for to be able to decelerate the motor in acceptable time.

2.4 I / O START STOP LOGIC

Values 0...4 offer possibilities to control the starting and stopping of the AC drive with digital signal connected to digital inputs. CS = Control signal.

The selections including the text 'edge' shall be used to exclude the possibility of an unintentional start when, for example, power is connected, re-connected after a power failure, after a fault reset, after the drive is stopped by Run Enable (Run Enable = False) or when the control place is changed to I / O control.

The Start / Stop contact must be opened before the motor can be started.

I/O stop logic uses accurate stop mode. Accurate stop mode is that the stop time is fixed from falling edge of DI to power stopping the drive.

Selection number	Selection name	Note
0	CS1:Forward CS2:Backward	The functions take place when the contacts are closed.

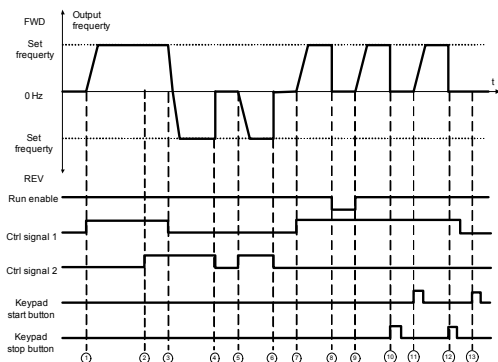

Figure 9.4: Start/Stop logic, selection 0

Explanations			
1	Control signal [CS] 1 activates causing the output frequency to rise. The motor runs forward.	8	Run enable signal is set to FALSE, which drops the frequency to 0. The run enable signal is configured with par. 5.7.
2	If start forward signal [CS1] and start reverse signal [CS2] are active simultaneously, there is alarm 55 in LCD panel when P13.23 FWD/REV conflict supervision=1.	9	Run enable signal is set to TRUE, which causes the frequency to rise towards the set frequency because CS1 is still active.
3	CS1 is inactivated which caused the direction to start changing [FWD to REV] because CS2 is still active, and alarm 55 should be disappeared in a while time.	10	Keypad stop button is pressed and the frequency fed to the motor drops to 0. (This signal only works if Par. 2.7 [Keypad stop button] = 1)
4	CS2 inactivates and the frequency fed to the motor drops to 0.	11	The drive starts through pushing the Start button on the keypad.
5	CS2 activates again causing the motor to accelerate [REV] towards the set frequency.	12	The keypad stop button is pushed again to stop the drive. (This signal only works if Par. 2.7 [Keypad stop button] = 1)
6	CS2 inactivates and the frequency fed to the motor drops to 0.	13	The attempt to start the drive through pushing the Start button is not successful because CS1 is inactive.
7	CS1 activates and the motor accelerates [FWD] towards the set frequency.		

Selection number	Selection name	Note
1	CS1:Forward(edge) CS2:Inverted stop	

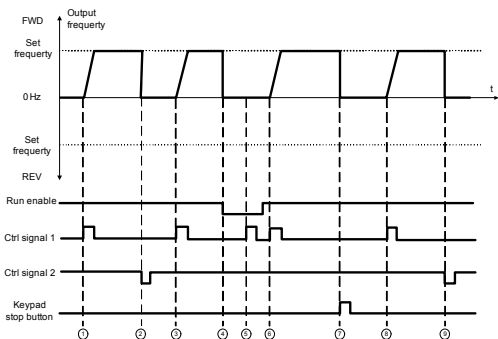

Figure 9.5: Start/Stop logic, selection 1

Explanations		
1	Control signal (CS) 1 activates causing the output frequency to rise. The motor runs forward.	6 CS1 activates and the motor accelerates (FWD) towards the set frequency because the Run enable signal has been set to TRUE.
2	CS2 inactivates causing the frequency to drop to 0.	7 Keypad stop button is pressed and the frequency fed to the motor drops to 0. (This signal only works if Par.2.7 [Keypad stop button] = 1)
3	CS1 activates causing the output frequency to rise again. The motor runs forward.	8 CS1 activates causing the output frequency to rise again. The motor runs forward.
4	Run enable signal is set to FALSE, which drops the frequency to 0. The run enable signal is configured with par. 5.7.	9 CS2 inactivates causing the frequency to drop to 0.
5	Start attempt with CS1 is not successful because Run enable signal is still FALSE.	

Selection number	Selection name	Note
2	CS1:Forward(edge) CS2:Backward(edge)	Shall be used to exclude the possibility of an unintentional start. The Start / Stop contact must be opened before the motor can be restarted.

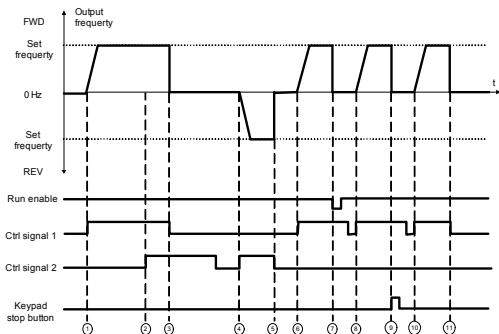

Figure 9.6: Start/Stop logic, selection 2

Explanations:			
1	Control signal [CS] 1 activates causing the output frequency to rise. The motor runs forward.	7	Run enable signal is set to FALSE, which drops the frequency to 0. The run enable signal is configured with par. 5.7.
2	If start forward signal [CS1] and start reverse signal [CS2] are active simultaneously, there is alarm 55 in LCD panel when P13.23 FWD/REV conflict supervision=1.	8	CS1 activates and the motor accelerates (FWD) towards the set frequency because the Run enable signal has been set to TRUE.
3	CS1 is inactivated the motor is still stopped though CS2 is still active, and alarm 55 should be disappeared in a while time.	9	Keypad stop button is pressed and the frequency fed to the motor drops to 0. (This signal only works if Par.2.7 [Keypad stop button] = 1)
4	CS2 activates again causing the motor to accelerate (REV) towards the set frequency.	10	CS1 is opened and closed again which causes the motor to start.
5	CS2 inactivates and the frequency fed to the motor drops to 0.	11	CS1 inactivates and the frequency fed to the motor drops to 0.
6	CS1 activates and the motor accelerates (FWD) towards the set frequency.		

Selection number	Selection name	Note
3	CS1:Start CS2:Reverse	

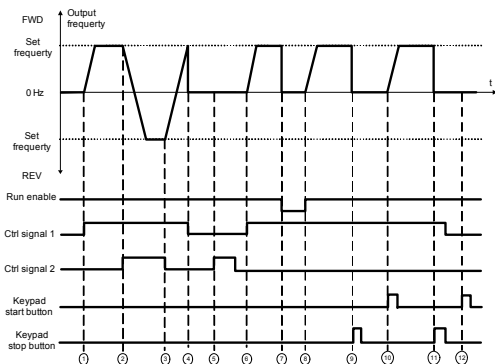

Figure 9.7: Start/Stop logic, selection 3

Explanations:			
1	Control signal (CS) 1 activates causing the output frequency to rise. The motor runs forward.	7	Run enable signal is set to FALSE, which drops the frequency to 0. The run enable signal is configured with par. 5.7.
2	CS2 activates which causes the direction to start changing (FWD to REV).	8	Run enable signal is set to TRUE, which causes the frequency to rise towards the set frequency because CS1 is still active.
3	CS2 is inactivated which causes the direction to start changing (REV to FWD) because CS1 is still active.	9	Keypad stop button is pressed and the frequency fed to the motor drops to 0. [This signal only works if Par.2.7 [Keypad stop button] = 1]
4	Also CS1 inactivates and the frequency drops to 0.	10	The drive starts through pushing the Start button on the keypad.
5	Despite the activates of CS2, the motor does not start because CS1 is inactive.	11	The drive is stopped again with the Stop button on the Keypad.
6	CS1 activates causing the output frequency to rise again. The motor runs forward because CS2 is inactive.	12	The attempt to start the drive through pushing the Start button is not successful because CS1 is inactive.

Selection number	Selection name	Note
4	CS1:Start(edge) CS2:Reverse	Shall be used to exclude the possibility of an unintentional start. The Start / Stop contact must be opened before the motor can be restarted.

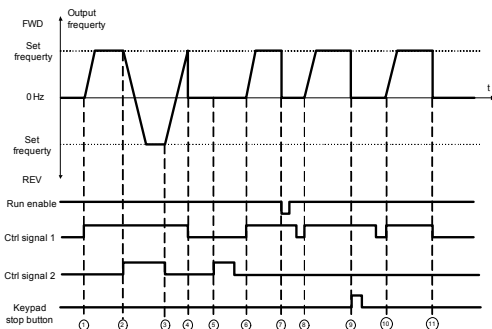

Figure 9.8: Start/Stop logic, selection 4

Explanations:			
1	Control signal (CS) 1 activates causing the output frequency to rise. The motor runs forward because CS2 is inactive..	7	Run enable signal is set to FALSE, which drops the frequency to 0. The run enable signal is configured with par. 5.7.
2	CS2 activates which causes the direction to start changing (FWD to REV).	8	Before a successful start can take place, CS1 must be opened and closed again.
3	CS2 is inactivated which causes the direction to start changing (REV to FWD) because CS1 is still active.	9	Keypad stop button is pressed and the frequency fed to the motor drops to 0. (This signal only works if Par.2.7 [Keypad stop button] = 1)
4	Also CS1 inactivates and the frequency drops to 0.	10	Before a successful start can take place, CS1 must be opened and closed again.
5	Despite the activation of CS2, the motor does not start because CS1 is inactive.	11	CS1 inactivates and the frequency drops to 0.
6	CS1 activates causing the output frequency to rise again. The motor runs forward because CS2 is inactive.		

2.5 LOCAL / REMOTE

This parameter defines whether the control place of the drive is remote (I / O or FieldBus) or local.

0 = Remote Control

1 = Local Control

The priority order of selecting control place is

1. PC control from Vacon live operation window
2. Loc / Rem button
3. Forced from I / O terminal

9.3 Frequency references (Control panel: Menu PAR -> P3)

3.3 REMOTE CONTROL PLACE FREQUENCY REFERENCE SELECTION

It defines the selected frequency reference source when the drive is remote control. A second reference source is programmable in par. 3.12.

- 1 = Preset speed 0
- 2 = Keypad reference
- 3 = Fieldbus Reference
- 4 = AI1
- 5 = AI2
- 6 = PID
- 7 = AI1+AI2
- 8 = Motor potentiometer
- 9 = Pulse train / Encoder

3.4 - 3.11 PRESET SPEEDS 0 - 7

Preset speed 0 is used as frequency reference when P3.3 = 1.

Preset speeds 1 - 7 can be used to determine frequency references that are applied when appropriate combinations of digital inputs are activated. Preset speeds can be activated from digital inputs despite of the active control place.

Parameter values are automatically limited between the minimum and maximum frequencies. [par. 3.1, 3.2].

Speed	Preset speed B2	Preset speed B1	Preset speed B0
Preset speed 1			x
Preset speed 2		x	
Preset speed 3		x	x
Preset speed 4	x		
Preset speed 5	x		x
Preset speed 6	x	x	
Preset speed 7	x	x	x

Table 9.1: Preset speeds 1 - 7

3.13 MOTOR POTENTIOMETER RAMP

3.14 MOTOR POTENTIOMETER RESET

P3.13 is the speed variation ramp when motor potentiometer reference is increased or decreased.

P3.14 tells under which circumstances the potentiometers reference should be reset and start over from 0 Hz.

- 0 = No Reset
- 1 = Reset if stopped
- 2 = Reset if powered down

P5.12 and P5.13 sets which digital inputs increase and decrease the motor potentiometers reference.

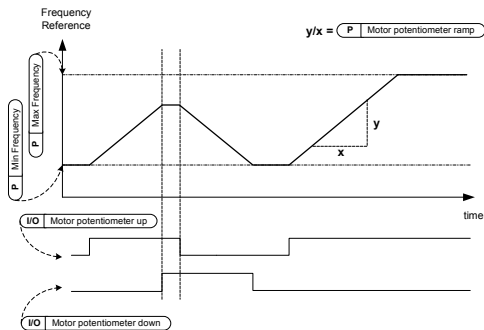

Figure 9.9: The change of motor potentiometers reference

9.4 Ramps & brakes setup (Control panel: Menu PAR -> P4)

4.1 RAMP S-SHAPE

The start and end of the acceleration and deceleration ramp can be smoothed with this parameter. Setting value 0 gives a linear ramp shape which causes acceleration and deceleration to act immediately to the changes in the reference signal.

Setting value 0.1...10 seconds for this parameter produces an S-shaped acceleration/deceleration. The acceleration and deceleration times are determined with parameters 4.2 and 4.3.

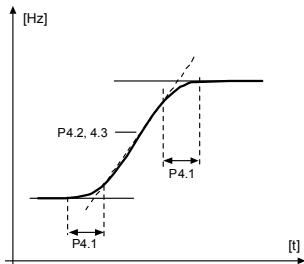

Figure 9.10: S-shaped acceleration/deceleration

4.2 ACCELERATION TIME 1

4.3 DECELERATION TIME 1

4.4 RAMP S-SHAPE 2

4.5 ACCELERATION TIME 2

4.6 DECELERATION TIME 2

These limits correspond to the time required for the output frequency to accelerate from the zero frequency to the set maximum frequency, or to decelerate from the set maximum frequency to zero frequency.

The user can set two different acceleration/deceleration time and set two different ramp s-shape for one application. The active set can be selected with the selected digital input (par. 5.11).

4.7 FLUX BRAKING

Instead of DC braking, flux braking is a useful form of braking with motors of max. 15 kW.

When braking is needed, the frequency is reduced and the flux in the motor is increased, which in turn increases the motor's capability to brake. Unlike DC braking, the motor speed remains controlled during braking.

- 0 = Off
- 1 = Deceleration
- 2 = Chopper
- 3 = Full Mode

Note: Flux braking converts the energy into heat at the motor, and should be used intermittently to avoid motor damage.

4.10 STOP DC CURRENT TIME

Determines if braking is ON or OFF and the braking time of the DC-brake when the motor is stopping. The function of the DC-brake depends on the stop function, par. 2.3.

- 0 = DC brake is not active
- >0 = DC brake is active and its function depends on the Stop function, (par. 2.3). The DC braking time is determined with this parameter.

Par. 2.3 = 0 (Stop function = Coasting):

After the stop command, the motor coasts to a stop without control from the frequency converter.

With the DC injection, the motor can be electrically stopped in the shortest possible time, without using an optional external braking resistor.

The braking time is scaled by the frequency when the DC-braking starts. If the frequency is greater, or equal to the nominal frequency of the motor, the set value of parameter 4.10 determines the braking time. When the frequency is 10% of the nominal, the braking time is 10% of the set value of parameter 4.10.

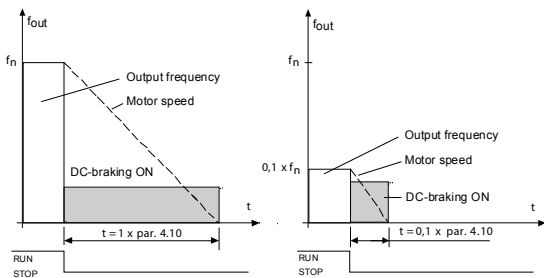

Figure 9.11: DC-braking time when Stop mode = Coasting

Par. 2.3 = 1 (Stop function = Ramp):

After the Stop command, the speed of the motor is reduced according to the set deceleration parameters, if the inertia of the motor and load allows that, to the speed defined with parameter 4.11, where the DC-braking starts.

The braking time is defined with parameter 4.10. See Figure 9.12.

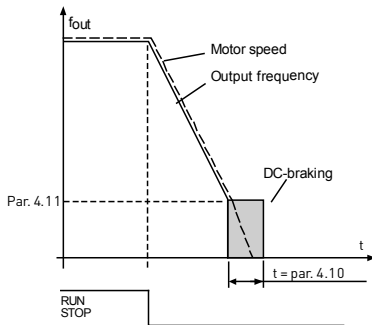

Figure 9.12: DC-braking time when Stop mode = Ramp

4.11 STOP DC CURRENT FREQUENCY

It is the output frequency at which the DC-braking is applied.

4.12 START DC CURRENT TIME

DC-brake is activated when the start command is given. This parameter defines the time for how long DC current is fed to motor before acceleration starts. After the brake is released, the output frequency increases according to the set start function by par. 2.2.

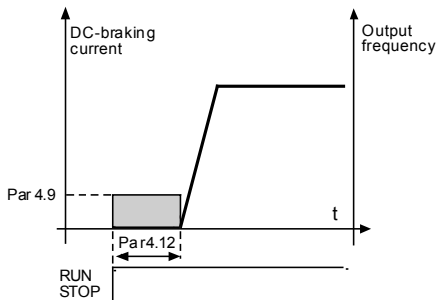

Figure 9.13: DC braking time at start

4.15 EXTERNAL BRAKE: OPEN DELAY

4.16 EXTERNAL BRAKE: OPEN FREQUENCY LIMIT

4.17 EXTERNAL BRAKE: CLOSE FREQUENCY LIMIT

4.18 EXTERNAL BRAKE: CLOSE FREQUENCY LIMIT IN REVERSE

4.19 EXTERNAL BRAKE: OPEN / CLOSE CURRENT LIMIT

External brake control is used for controlling a mechanical brake on the motor by digital / relay output by selecting value 17 for parameters P8.1, P8.2 or P8.3. Brake is closed while relay is open and vice versa.

Opening brake conditions:

There are three different conditions for opening the brake, all must be true, if used.

1. The Open frequency limit (P4.16) must be reached.

- When the Opening frequency limit has been reached the Open delay (P4.15) must also elapse. Note! The output frequency is held at the Open frequency limit until this.
- When the two previous conditions are reached. The brake will open if the output current is higher than the current limit.(P4.19)

Notice that any of the previous conditions can be left out by setting their values to zero.

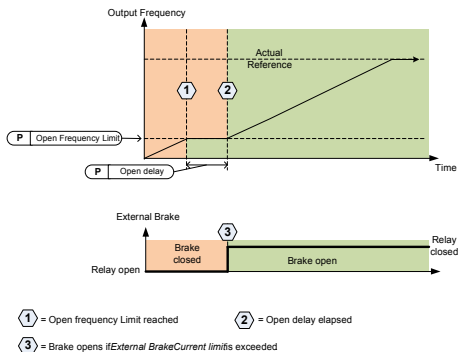

Figure 9.14: Starting / opening sequence with external brake

Closing brake conditions:

There are 2 conditions for closing the brake again. It's enough that one is true for the brake to close.

- If there is no run command active and output frequency goes below Close frequency limit (P4.17) or Close frequency limit in reverse (P4.18), depending on direction of rotation.
OR
- Output current has gone below Current limit.(P4.19)

9.5 Digital inputs (Control panel: Menu PAR -> P5)

These parameters are programmed using the FTT-method (Function To Terminal), where you have a fixed input or output that you define a certain function for. You can also define more than one function to a digital input, e.g. Start signal 1 and Preset Speed B1 to DI1.

The selections for these parameters are:

0 = Not used

1 = DI1

2 = DI2

3 = DI3

4 = DI4

5 = DI5

6 = DI6

5.1 I / O CTRL SIGNAL 1

5.2 I / O CTRL SIGNAL 2

P5.1 and P5.2 : See P2.4 (I/O start stop logic) for function

5.3 REVERSE

The digital input only active when P2.4 (I/O Start stop logic) =1

The motor will run in reverse when the rising edge of P5.3 is happened.

5.11 RAMP TIME 2 SELECTION

Contact open: Acceleration / Deceleration time 1 and Ramp S-shape selected

Contact closed: Acceleration / Deceleration time 2 and Ramp S-shape2 selected

Set Acceleration / Deceleration time with parameters 4.2 and 4.3 and the alternative Acceleration / Deceleration time with 4.4 and 4.5.

Set Ramp S-shape with Par. 4.1 and the alternative Ramp S-shape2 with Par. 4.4

5.16 PID SETPOINT 2

Digital input high activates setpoint 2 (P15.3), when P15.1=0.

5.17 MOTOR PREHEAT ACTIVE

Digital input high activates the Motor preheat function (if P16.1 = 2) which feeds DC-Current to the motor in stop state.

9.6 Analogue inputs (Control panel: Menu PAR -> P6)

6.3 AI1 CUSTOM MAXIMUM

6.4 AI1 FILTER TIME

6.6 AI2 CUSTOM MINIMUM

6.7 AI2 CUSTOM MAXIMUM

These parameters set the analogue input signal for any input signal span from minimum to maximum.

6.8 AI2 FILTER TIME

This parameter, given a value greater than 0, activates the function that filters out disturbances from the incoming analogue signal.

Long filtering time makes the regulation response slower. See Figure 9.15.

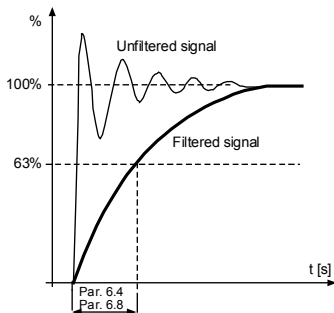

Figure 9.15: AI1 and AI2 signal filtering

9.7 Pulse train / Encoder (Control panel: Menu PAR -> P7)

7.1 MIN PULSE FREQUENCY

7.2 MAX PULSE FREQUENCY

Minimum and maximum pulse frequency correspond to a signal value of 0% and 100% respectively. Frequencies over Max pulse frequency are handled as constant 100% and below Min pulse frequency as constant 0%. The signal value of range 0 - 100% is shown in monitor value V2.7 and can be used as PID Controller feedback, or scaled to frequency with parameters P7.3 and P7.4, and used as frequency reference.

7.3 FREQ REF AT MIN PULSE FREQUENCY

7.4 FREQ REF AT MAX PULSE FREQUENCY

Pulse train/Encoder signal with range 0-100% and scaled by parameter P7.1 and P7.2, which can be used as frequency reference by telling what frequency corresponds to 0% and 100% with parameters P7.3 and P7.4 respectively. Then it can be selected as frequency reference for Remote control place.

7.5 ENCODER DIRECTION

It is possible to also take direction information from the encoder.

0 = Disable

1 = Enable/Normal

2 = Enable/Inverted

7.6 ENCODER PULSES / REVOLUTION

Encoder pulses per revolution can be set in case an encoder is used, which is used to record the count of encoder per round. In this case monitor value V2.8 will show the actual rpm of the encoder.

Maximum pulse frequency is 10 kHz. It means that a 256 pulse per round encoder would allow shaft speeds up to 2300 rpm. ($60 \cdot 10000 / 256 = 2343$)

7.7 CONFIG DI5 AND DI6

0 = DI5 and DI6 are for normal digital input

1 = DI6 is for pulse train

2 = DI5 and DI6 are for encoder frequency mode



When using pulse train / encoder input, DI5 and DI6 should not be used as other parameters value, especially pay attention to P5.4 and P5.9 which factory default value is DI6 and DI5.

Note! If use the encoder function have to do 2 steps:

- 1) Set the parameter to change normal DI to Encoder in menu firstly.
- 2) Then push down the DI switch for encoder function.
otherwise F51 occur.

9.8 Digital outputs (Control panel: Menu PAR -> P8)

8.1 RO1 SIGNAL SELECTION**8.2 RO2 SIGNAL SELECTION****8.3 DO1 SIGNAL SELECTION**

Setting	Signal content
0 = Not used	Output is not in operation.
1 = Ready	The frequency converter is ready to operate.
2 = Run	The frequency converter operates (motor is running).
3 = Fault	A fault trip has occurred.
4 = Fault inverted	A fault trip has not occurred.
5 = Warning	A warning is active.
6 = Reversed	The reverse command has been selected, output frequency to the motor is negative.
7 = At speed	The output frequency has reached the set reference.
8 = Motor regulator active	Each of Motor regulator is active (e.g., over current regulator, over voltage regulator, under voltage regulator, etc.)
9 = FB Control Word.B13	Output can be controlled with B13 in the fieldbus control word.
10 = FB Control Word.B14	Output can be controlled with B14 in the fieldbus control word.
11 = FB Control Word.B15	Output can be controlled with B15 in the fieldbus control word.
12 = Output frequency superv.	Output frequency is over / under the limits, set with parameters P12.1 and P12.2.
13 = Output torque superv.	Motor torque is over/under the limit, set with parameter P12.3 and P12.4.
14 = Unit temperature superv.	Unit temperature is over / under the limits, set with parameters P12.5 and P12.6.
15 = Analogue input superv.	Analogue inputs set with parameter P12.7 is over / under the limits, set in P12.8 and P12.9.
16 = Preset Speed Active	Each of preset speeds are activated.
17 = External Brake control	External Brake control. Closed = Brake open, Open = Brake closed.
18 = Keypad control active	Keypad is set as the current control place.
19 = I / O control active	I / O is set as the current control place.

Table 9.2: Output signals via RO1, RO2 and DO1

9.9 Analogue outputs (Control panel: Menu PAR -> P9)**9.1 ANALOG OUTPUT SIGNAL SELECTION**

- 0 = Not used
- 1 = Output frequency (0 - f_{max})
- 2 = Output current (0 - I_{nMotor})
- 3 = Motor torque (0 - T_{nMotor})
- 4 = PID output (0 - 100%)
- 5 = Frequency reference (0 - f_{max})
- 6 = Motor speed (0 - n_{max})
- 7 = Motor power (0 - P_{nMotor})
- 8 = Voltage (0 - U_{nMotor})
- 9 = DC-link Voltage (0 - 1000V)
- 10 = Process Data In1 (0 - 10000)
- 11 = Process Data In2 (0 - 10000)
- 12 = Process Data In3 (0 - 10000)
- 13 = Process Data In4 (0 - 10000)
- 14 = Test 100%

9.2 ANALOG OUTPUT MINIMUM

- 0 = 0 V / 0 mA
- 1 = 2 V / 4 mA

9.10 Fieldbus Data-Mapping (Control panel: Menu PAR -> P10)

10.1 FB DATA OUT 1 SELECTION

Parameter couples read only variables to output process data 1.

- 0 = Frequency reference
- 1 = Output reference
- 2 = Motor speed
- 3 = Motor current
- 4 = Motor voltage
- 5 = Motor torque
- 6 = Motor power
- 7 = DC link voltage
- 8 = Active fault code
- 9 = Analogue AI1
- 10 = Analogue AI2
- 11 = Digital input state
- 12 = PID feedback value
- 13 = PID setpoint
- 14 = Pulse train / encoder input[%]
- 15 = Pulse train / encoder pulse[]

10.9 AUX CW DATA IN SELECTION

Parameter defines the input process data coupled to Aux Control Word.

- 0 = Not used
- 1 = PDI1
- 2 = PDI2
- 3 = PDI3
- 4 = PDI4
- 5 = PDI5

9.11 Prohibited Frequencies (Control panel: Menu PAR -> P11)

11.1 PROHIBIT FREQUENCY RANGE 1: LOW LIMIT

11.2 PROHIBIT FREQUENCY RANGE 1: HIGH LIMIT

11.3 PROHIBIT FREQUENCY RANGE 2: LOW LIMIT

11.4 PROHIBIT FREQUENCY RANGE 2: HIGH LIMIT

Two skip frequency regions are available if there is a need to avoid certain frequencies because of e.g. mechanical resonance. In this case the actual frequency reference sent to the motor control will be kept out of these ranges according to the example below, where one range is in use.

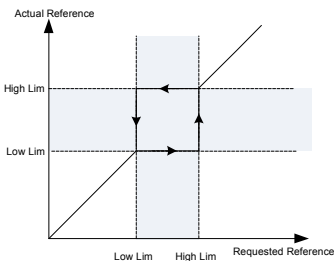

Figure 9.16: Frequency Range

9.12 Protections (Control panel: Menu Par->P13)

13.5 STALL PROTECTION

- 0 = No action
- 1 = Alarm
- 2 = Fault, stop function
- 3 = Fault, coast

The motor stall protection protects the motor from short time overload situations such as one caused by a stalled shaft. The reaction time of the stall protection can be set shorter than that of motor thermal protection. The stall state is defined with two parameters, P13.11 (Stall current) and P13.13 (Stall frequency limit). If the current is higher than the set limit and the output frequency is lower than the set limit the stall state is true. There is actually no real indication of the shaft rotation. Stall protection is a type of over current protection.

13.6 UNDER LOAD PROTECTION

- 0 = No action
- 1 = Alarm
- 2 = Fault, stop function
- 3 = Fault, coast

The purpose of the motor underload protection is to ensure that there is load on the motor when the drive is running. If the motor loses its load there might be a problem in the process, e.g. a broken belt or a dry pump.

Motor underload protection can be adjusted by setting the underload curve with parameters P13.14 (Underload protection: Field weakening area load) and P13.15 (Underload protection: Zero frequency load), see the figure below. The underload curve is a squared curve set between the zero frequency and the field weakening point. The protection is not active below 5Hz (the underload time counter is stopped).

The torque values for setting the underload curve are set in percentage which refers to the nominal torque of the motor. The motor's name plate data, parameter motor nominal current and the drive's nominal current I_L are used to find the scaling ratio for the internal torque value. If other than nominal motor is used with the drive, the accuracy of the torque calculation decreases.

The default parameter value of the underload protection time limit is 20 seconds, which is the maximum time allowed for an underload state to exist before causing a trip according to this parameter.

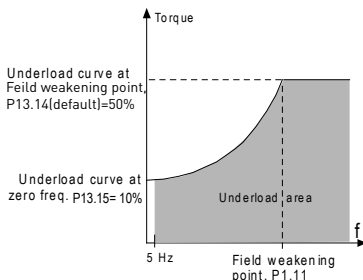

Figure 9.17: Underload protection

13.7 MOTOR THERMAL PROTECTION

- 0 = No action
- 1 = Alarm
- 2 = Fault, stop function
- 3 = Fault, coast

If tripping is selected the drive will stop and activate the fault stage, if the temperature of the motor becomes too high. Deactivating the protection, i.e. setting parameter to 0, will reset the thermal model of the motor to 0%.

The motor thermal protection is to protect the motor from overheating. The drive is capable of supplying higher than nominal current to the motor. If the load requires this high current there is a risk that the motor will be thermally overloaded. This is the case especially at low frequencies. At low frequencies the cooling effect of the motor is reduced as well as its capacity. If the motor is equipped with an external fan the load reduction at low speeds is small.

The motor thermal protection is based on a calculated model and it uses the output current of the drive to determine the load on the motor.

The motor thermal protection can be adjusted with parameters. The thermal current I_T specifies the load current above which the motor is overloaded. This current limit is a function of the output frequency.

The thermal stage of the motor can be monitored on the control keypad display.

CAUTION! The calculated model does not protect the motor if the airflow to the motor is reduced by blocked air intake grill.

NOTE! To comply with UL 508C requirements motor over-temperature sensing is required at installation if the parameter is set to 0.

Note: If you use long motor cables (max. 100m) together with small drives (<=1.5 kW) the motor current measured by the drive can be much higher than the actual motor current due to capacitive currents in the motor cable. Consider this when setting up the motor thermal protection functions.

13.8 MTP:AMBIENT TEMPERATURE

When the motor ambient temperature must be taken into consideration, it is recommended to set a value for this parameter. The value can be set between -20 and 100 degrees Celsius.

13.9 MTP:ZERO SPEED COOLING

Defines the cooling factor at zero speed in relation to the point where the motor is running at nominal speed without external cooling. The default value is set assuming that there is no external fan cooling the motor. If an external fan is used this parameter can be set to 90% (or even higher).

If you change the parameter P1.4 (Motor nominal current), this parameter is automatically restored to the default value. Setting this parameter does not affect the maximum output current of the drive which is determined by parameter P1.7 alone.

The corner frequency for the thermal protection is 70% of the motor nominal frequency(P1.2).

The cooling power can be set between 0 - 150.0% x cooling power at nominal frequency. See Figure 9.18.

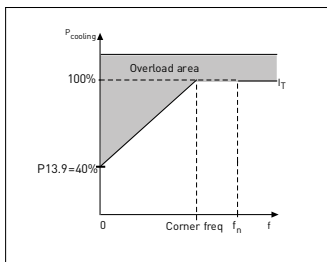

Figure 9.18: Motor thermal current I_T curve

13.10 MTP:THERMAL TIME CONSTANT

This time can be set between 1 and 200 minutes.

This is the thermal time constant of the motor. The bigger the frame and/or slower the speed of the motor, the longer the time constants. The time constant is the time within which the calculated thermal model has reached 63% of its final value.

The motor thermal time is specific to the motor design and it varies between different motor manufacturers.

If the motor's t_6 -time (t_6 is the time in seconds the motor can safely operate at six times the rated current) is known (given by the motor manufacturer) the time constant parameter can be set basing on it. As a rule of thumb, the motor thermal time constant in minutes equals to $2 \times t_6$. If the drive is in stop state the time constant is internally increased to three times the set parameter value. See also Figure 9.19.

The cooling in stop stage is based on convection and the time constant is increased.

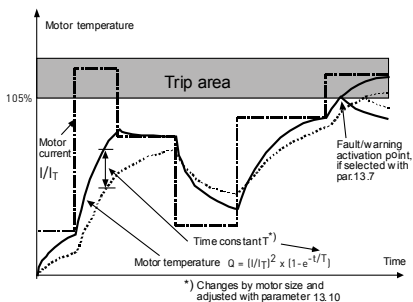

Figure 9.19: Motor temperature calculation

P13.11 STALL CURRENT

The current can be set to $0.0...2 \times I_{Nunit}$. For a stall stage to occur, the current must have exceeded this limit. If parameter P1.7 Motor current limit is changed, this parameter is automatically calculated to 90% of the current limit. See Figure 9.20.

NOTE! In order to guarantee desired operation, this limit must be set below the current limit.

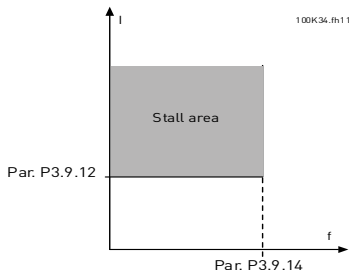

Figure 9.20: Stall current

P13.12 STALL TIME

This time can be set between 0.00 and 300.00s.

This is the maximum time allowed for a stall stage. The stall time is counted by an internal up/down counter.

If the stall time counter value goes above this limit the protection will cause a trip (see P13.5). See Figure 9.21.

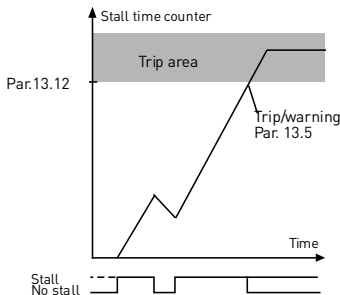

Figure 9.21: Stall time calculation

P13.14 UNDERLOAD PROTECTION: FIELD WEAKENING AREA LOAD

The torque limit can be set between 10.0-150.0 % x T_{nMotor} .

This parameter gives the value for the minimum torque allowed when the output frequency is above the field weakening point. If you change parameter P1.4 (Motor nominal current) this parameter is automatically restored to the default value.

P13.16 UNDERLOAD PROTECTION: TIME LIMIT

This time can be set between 2.0 and 600.0 s.

This is the maximum time allowed for an underload state to exist. An internal up/down counter counts the accumulated underload time. If the underload counter value goes above this limit the protection will cause a trip according to parameter P13.6). If the drive is stopped the underload counter is reset to zero. See Figure 9.22.

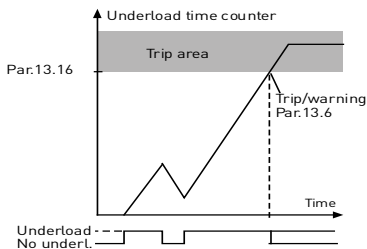

Figure 9.22: underload counter

13.28 INPUT PHASE FAULT

- 0: No action
- 1: Alarm
- 2: Fault: Stop function
- 3: Fault: Coast

13.29 MOTOR TEMPERATURE MEMORY MODE

- 0 = disabled
- 1 = constant mode
- 2 = last value mode

9.13 Automatic reset (Control panel: Menu PAR -> P14)

14.1 AUTOMATIC RESET

Activate the Automatic reset after fault with this parameter.

NOTE: Automatic reset is allowed for certain faults only.

- Fault: 1. Under voltage
 2. Over voltage
 3. Over current
 4. Motor over temperature
 5. Under load

14.3 TRIAL TIME

The Automatic restart function restarts the frequency converter when the faults have disappeared and the waiting time has elapsed.

The time count starts from the first auto reset. If the number of faults occurring during the trial time exceeds trial number (the value of P14.4), the fault state becomes active. Otherwise the fault is cleared after the trial time has elapsed and the next fault starts the trial time count again. See Figure 9.23.

If a single fault remains during the trial time, a fault state is true.

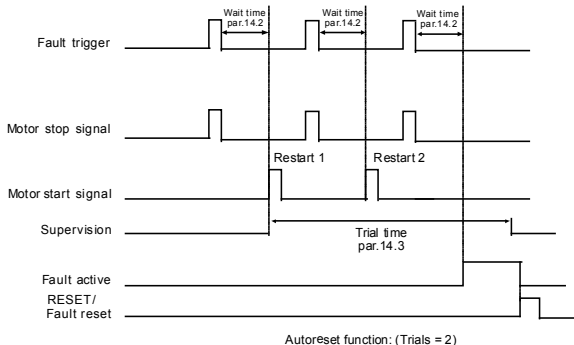

Figure 9.23: Example of Automatic restarts with two restarts

9.14 PID control parameters (Control panel: Menu PAR -> P15)

15.5 FEEDBACK VALUE MINIMUM

15.6 FEEDBACK VALUE MAXIMUM

This parameter sets the minimum and maximum scaling points for feedback value.

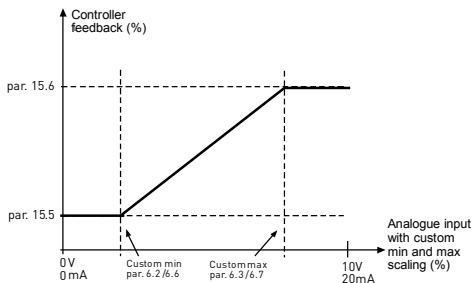

Figure 9.24: Feedback minimum and maximum

15.7 P GAIN

This parameter defines the gain of the PID controller. If the value of the parameter is set to 100%, a change of 10% in the error value causes the controller output to change by 10%.

15.8 PID CONTROLLER I-TIME

This parameter defines the integration time of the PID controller. If this parameter is set to 1,00 second, the controller output is changed by a value corresponding to the output caused from the gain every second. $[\text{Gain} \cdot \text{Error}] / \text{s}$.

15.9 PID CONTROLLER D-TIME

This parameter defines the derivative time of the PID controller. If this parameter is set to 1,00 second, a change of 10% in the error value causes the controller output to change by 10%.

15.11 SLEEP MIN FREQUENCY**15.12 SLEEP DELAY****15.13 WAKE-UP ERROR**

This function will put the drive into sleep mode if the frequency stays below the sleep limit for a longer time than that set with the Sleep Delay (P15.12). This means that the start command remains on, but the run request is turned off. When the actual value goes below, or above, the wake-up error depending on the set acting mode the drive will activate the run request again if the start command is still on.

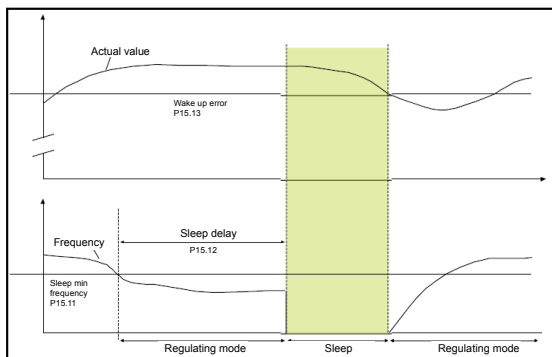

Figure 9.25: Sleep min frequency, Sleep delay, Wake-up error

15.14 SLEEP SETPOINT BOOST**15.15 SETPOINT BOOST TIME****15.16 SLEEP MAX LOSS****15.17 SLEEP LOSS CHECK TIME**

These parameters manage a more complex sleep sequence. After the time in P15.12, the setpoint is increased of the term in P15.14, for the time in P15.15. This will cause a higher output frequency.

Frequency reference is then forced at minimum frequency and the feedback value is sampled.

If the variation on the feedback value stays then lower than P15.16 for the time in P15.17, the drive will enter sleep condition.

If this sequence is not needed, then program P15.14 = 0%, P15.15 = 0 s, P15.16 = 50%, P15.17 = 1 s.

15.18 PROCESS UNIT SOURCE SELECTION

Monitor V4.5 can show a process value, proportional to a variable measured by the drive. Source variables are:

- 0 = PID feedback value (max: 100%)
- 1 = Output frequency (max: fmax)
- 2 = Motor speed (max: nmax)
- 3 = Motor torque (max: Tnom)
- 4 = Motor power (max: Pnom)
- 5 = Motor current (max: Inom)
- 6 = Pulse train/ Encoder (max: 100%)

15.19 PROCESS UNIT DECIMAL DIGITS

Number of decimals shown on monitor V4.5.

15.20 PROCESS UNIT MIN VALUE

Value shown on V4.5 when source variable is at its minimum. Proportionality is kept if source overtakes the minimum.

15.21 PROCESS UNIT MAX VALUE

Value shown on V4.5 when source variable is at its maximum. Proportionality is kept if source overtakes the maximum.

9.15 Application setting (Control panel: Menu PAR->P17)

17.1 DRIVE SETUP

With this parameter you can easily set up your drive for four different applications.

Note! This parameter is only visible when the Startup Wizard is active. The startup wizard will start in first power-up. It can also be started by setting SYS P4.2=1. See the figures below.

NOTE! Running the startup wizard will always return all parameter settings to their factory defaults!

NOTE! StartUp-Wizard can be skipped after pressing STOP button continuously for 30 seconds

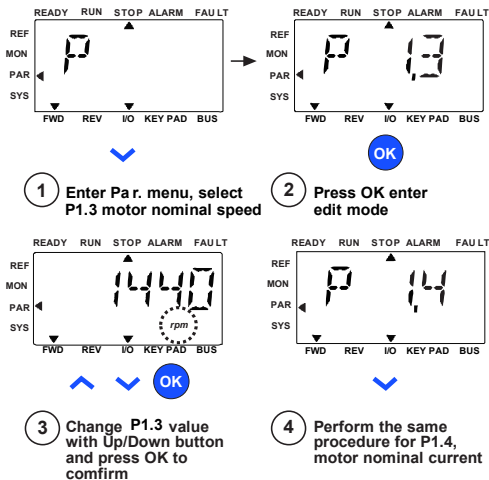
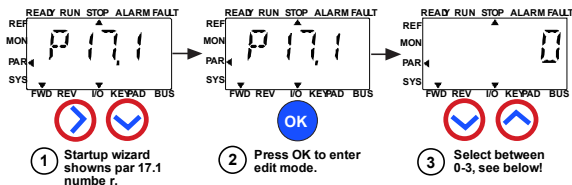

Figure 9.26: Startup wizard



Selections:

	P1.7	P1.8	P1.15	P2.2	P2.3	P3.1	P4.2	P4.3
0 = Basic	1,5 x InMOT	0= Frequency control	0= Not used	0= Ramp	0= Coast	0 Hz	3s	3s
1 = Pump drive	1,1 x InMOT	0= Frequency control	0= Not used	0= Ramp	1= Ramp	20 Hz	5s	5s
2 = Fan drive	1,1 x InMOT	0= Frequency control	0= Not used	1= Flying	0= Coast	20 Hz	20s	20s
3 = High Torque drive	1,5 x InMOT	1= Open loop speed control	1= used	0= Ramp	0= Coast	0 Hz	1s	1s

Parameters affected:

P1.7 Current limit (A)	P2.3 Stop function
P1.8 Motor control mode	P3.1 Min frequency
P1.15 Torque boost	P4.2 Acc. time (s)
P2.2 Start function	P4.3 Dec time (s)

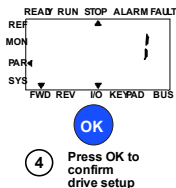

Figure 9.27: Drive setup

17.4 APPLICATION ACCESS PASSWORD

Input the right password could review parameter group 18.

9.16 System parameter

4.3 PASSWORD

VACON20 API provides password function that is used when changing parameter value.

Inside PAR or SYS menu the selected parameter symbol and its value are alternating in the display. The single OK button pressing causes entering to the parameter value change mode.

If password protection is ON, user is asked to enter the right password (defined with parameter P4.3) and press OK button before editing value is possible. The password consists of four digit numbers, factory default value is 0000 = Password Disabled. Editing of all the parameters (including System parameters) is prohibited if the correct password has not been entered. If wrong password is entered, pressing OK button causes return to the main level.

Password Parameters:

VACON20 API has one password parameter P4.3 "Password";

Parameter P4.3 is a 4 digit number. Factory default will be 0000 = Password disabled;

Any other value than 0000 will enable the password and it is not possible to change parameters. In this status all parameters are visible;

When navigate to Parameter P4.3, show "PPPP" as a parameter value if password has been set.

Activating a password:

Navigate to Parameter P4.3;

Press OK button;

Cursor (lowest horizontal segment) of the very left digit flashes;

Select first digit of password by using UP and DOWN key;

Press RIGHT button;

Cursor of the second digit flashes;

Select second digit of password by using UP and DOWN key;

Press RIGHT button;

Cursor of the third digit flashes;

Select third digit of password by using UP and DOWN key;

Press RIGHT button;

Cursor of the fourth digit flashes;

Select fourth digit by using UP and DOWN key;

Press OK button --> the cursor of the first digit flashes;

Repeat insertion of password;
Press OK button --> password is locked;
In case of different values for the two passwords: display Fault;
Press OK button --> repeat password a second time;
To interrupt insertion of Password --> Press BACK / RES.

Disabling a password:

Insert the actual password --> Press OK --> Password is automatically set to 0000;
All parameters can then freely be changed;
To enable password again --> see 'Activating a password' procedure.

Change of one parameter:

User tries to change a parameter value when password is enabled --> display PW;
Press OK button;
Cursor (lowest horizontal segment) of the very left digit flashes;
Select first digit of password by using UP and DOWN key;
Press RIGHT button;
Cursor of the second digit flashes;
Select second digit of password by using UP and DOWN key;
Press RIGHT button;
Cursor of the third digit flashes;
Select third digit of password by using UP and DOWN key;
Press RIGHT button;
Cursor of the fourth digit flashes;
Select fourth digit by using UP and DOWN key;
Press OK button;
Current value of parameter to be changed will be display;
Change parameter value as normal;
Press OK --> New parameter value will be stored and Password is enabled again;
For changing another parameter the procedure has to be repeated;
In the case of wanting to change multiple parameters it is of advantage to set P4.3 to 0000;
After the change of the parameter values password has to be activated again;

Forgotten password:

Follow procedure "Disabling a password" and select 6020 as actual password.

9.17 Modbus RTU

Vacon 20 has a built-in Modbus RTU bus interface. The signal level of the interface is in accordance with the RS-485 standard.

The built-in Modbus connection of Vacon 20 supports the following function codes:

Function code	Function name	Address	Broadcast messages
03	Read Holding Registers	All ID numbers	No
04	Read Input Registers	All ID numbers	No
06	Write Single Registers	All ID numbers	Yes
16	Write multiple registers	All ID numbers	Yes

Table 9.3: Modbus RTU

9.17.1 Termination resistor

The RS-485 bus is terminated with termination resistors of 120 ohms in both ends. Vacon 20 has a built-in termination resistor which is switched off as a default (presented below). The termination resistor can be switched on and off with the right hand dip switch located above IO-terminals in the front of the drive (see below).

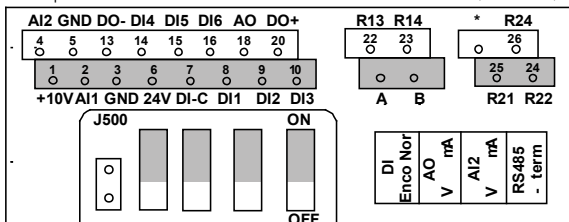

Figure 9.28: Vacon 20 I/O

9.17.2 Modbus address area

The Modbus interface of Vacon 20 uses the ID numbers of the application parameters as addresses. The ID numbers can be found in the parameter tables in chapter 8.

When several parameters / monitoring values are read at a time, they must be consecutive. 11 addresses can be read and the addresses can be parameters or monitoring values.

Note: With some PLC manufacturers, the interface driver for Modbus RTU communication may contain an offset of 1 (the ID number to be used would then subtract 1).

9.17.3 Modbus process data

Process data is an address area for fieldbus control. Fieldbus control is active when the value of parameter 2.1 (Control place) is 1 (= fieldbus). The content of the process data can be programmed in the application. The following tables present the process data contents in Vacon20 Application.

ID	Modbus register	Name	Scale	Type
2101	32101, 42101	FB Status Word	-	Binary coded
2102	32102, 42102	FB General Status Word	-	Binary coded
2103	32103, 42103	Reserved	0,01	%
2104	32104, 42104	Programmable by P10.1 (Default: Frequency reference)	-	-
2105	32105, 42105	Programmable by P10.2 (Default: Output frequency)	0,01	+/- Hz
2106	32106, 42106	Programmable by P10.3 (Default: Motor speed)	1	+/- Rpm
2107	32107, 42107	Programmable by P10.4 (Default: Motor voltage)	0,1	V
2108	32108, 42108	Programmable by P10.5 (Default: Motor torque)	0,1	+/- % (of nominal)
2109	32109, 42109	Programmable by P10.6 (Default: Motor current)	0,01	A
2110	32110, 42110	Programmable by P10.7 (Default: Motor power)	0,1	+/- % (of nominal)
2111	32111, 42111	Programmable by P10.8 (Default: DC link voltage)	1	V

Table 9.4: Output process data

ID	Modbus register	Name	Scale	Type
2001	32001, 42001	FB Control Word	-	Binary coded
2002	32002, 42002	FB General Control Word	-	Binary coded
2003	32003, 42003	Reserved	0,01	%
2004	32004, 42004	Programmable by P10.9		
2005	32005, 42005	Programmable by P10.9		
2006	32006, 42006	Programmable by P10.9		
2007	32007, 42007	Programmable by P10.9		
2008	32008, 42008	Programmable by P10.9		

Table 9.5: Input process data

ID	Modbus register	Name	Scale	Type
2009	32009, 42009	-	-	-
2010	32010, 42010	-	-	-
2011	32011, 42011	-	-	-

Table 9.5: Input process data

Note! 2004 - 2007 can set as PID Control Reference by setting P15.1(Set-point selection) or PID Actual value by setting P15.4(Feedback value selection)!

2004 - 2007 can be set as the Analogue Output by P9.1, P9.5, P9.9.

2004 - 2008 can set as Aux Control Word with P10.9:

- b0: Run enable
- b1: acc / dec ramp 2 selection
- b2: freq reference 2 selection

Note!- AUX CW is active when configured, even if control place is not the fieldbus

- b0 Run enable is computed in AND with a possible Run enable signal from digital input. Fall of enable will cause coasting stop.

Status word (output process data)

Information about the status of the device and messages is indicated in the Status word. The Status word is composed of 16 bits the meanings of which are described in the table below:

Bit	Description	
	Value = 0	Value = 1
B0, RDY	Drive not ready	Drive ready
B1, RUN	Stop	Run
B2, DIR	Clockwise	Counter-clockwise
B3, FLT	No fault	Fault active
B4, W	No alarm	Alarm active
B5, AREF	Ramping	Speed reference reached
B6, Z	-	Drive is running at zero speed
B7 - B15	-	-

Table 9.6: Status word (output process data)

General status word (output process data)

Information about the status of the device and messages is indicated in the General status word. The General status word is composed of 16 bits the meanings of which are described in the table below:

Bit	Description			
	Value = 0		Value = 1	
B0, RDY	Drive not ready		Drive ready	
B1, RUN	Stop		Run	
B2, DIR	Clockwise		Counter-clockwise	
B3, FLT	No fault		Fault active	
B4, W	No alarm		Alarm active	
B5, AREF	Ramping		Speed reference reached	
B6, Z	-		Drive is running at zero speed	
B7, F	-		Fieldbus control active	
B8 - B12	-		-	
Bit	Control place			
	I/O	PC tool	Keypad	Fieldbus
B13	1	0	0	0
B14	0	1	1	0
B15	0	1	0	1

Table 9.7: General status word (output process data)

Actual speed (output process data)

This is actual speed of the frequency converter. The scaling is -10000...10000. The value is scaled in percentage of the frequency area between set minimum and maximum frequency.

Control word (input process data)

The three first bits of the control word are used to control the frequency converter. By using control word it is possible to control the operation of the drive. The meanings of the bits of control word are explained in the table below:

Bit	Description	
	Value = 0	Value = 1
B0, RUN	Stop	Run
B1, DIR	Clockwise	Counter-clockwise
B2, RST	Rising edge of this bit will reset active fault	
B5, Quick ramp time	Normal deceleration ramp time	Quick deceleration ramp time

Table 9.8: Control word (input process data)

Speed reference (input process data)

This is the Reference 1 to the frequency converter. Used normally as Speed reference. The allowed scaling is 0...10000. The value is scaled in percentage of the frequency area between the set minimum and maximum frequencies.

10. TECHNICAL DATA

10.1 Vacon 20 technical data

Mains connection	Input voltage U_{in}	115 V, -15%...+10% 1- 208...240 V, -15%...+10% 1- 208...240 V, -15%...+10% 3- 380 - 480 V, -15%...+10% 3- 600 V, -15%...+10% 3-
	Input frequency	45...66 Hz
	Connection to mains	Once per minute or less (normal case)
Supply network	Networks	Vacon 20 (400 V) cannot be used with corner grounded networks
	Short circuit current	Maximum short circuit current has to be < 50 kA, For MI4 without DC-choke, maximum short circuit current has to be < 2.3 kA, for MI5 without DC-choke, maximum short circuit current has to be < 3.8 kA
Motor connection	Output voltage	0 - U_{in}
	Output current	Continuous rated current I_N at ambient temperature max. +50 °C (depends on the unit size), overload 1.5 x I_N max 1 min / 10 min
	Starting current / torque	Current 2 x I_N for 2 sec in every 20 sec period. Torque depends on motor
	Output frequency	0...320 Hz
	Frequency resolution	0,01 Hz
Control connection	Digital input	Positive, Logic1: 18...+30V, Logic0: 0...5V; Negative, Logic1: 0...10V, Logic0: 18...30V; $R_i = 10K\Omega$ [floating]
	Analogue input voltage	0...+10V, $R_i = 250K\Omega$
	Analogue input current	0[4]...20mA, $R_i \leq 250\Omega$
	Analogue output	0...10V, $R_L \geq 1K\Omega$; 0[4]...20mA, $R_L \leq 500\Omega$, Selectable through microswitch
	Digital output	Open collector, max. load 35V/50mA (floating)
	Relay output	Switching load: 250Vac/3A, 24V DC 3A
	Auxiliary voltage	$\pm 20\%$, max.load 50mA

Table 10.1: Vacon 20 technical data

Control characteristics	Control method	Frequency Control U / f Open Loop Sensorless Vector Control
	Switching frequency	1...16 kHz; Factory default 4 kHz
	Frequency reference	Resolution 0.01 Hz
	Field weakening point	30...320 Hz
	Acceleration time	0.1...3000 sec
	Deceleration time	0.1...3000 sec
	Braking torque	100%*T _N with brake option (only in 3- drives sizes MI2-5) 30%*T _N without brake option
Ambient conditions	Ambient operating temperature	-10 °C (no frost)...+40 / 50 °C (depends on the unit size): rated loadability I _N Side by side installation for MI1-3 it is always 40 °C; For IP21/Nema1 option in MI1-3 the maximum temperature is also 40 °C
	Storage temperature	-40 °C...+70 °C
	Relative humidity	0...95% RH, non-condensing, non-corrosive, no dripping water
	Air quality: - chemical vapours - mech. particles	IEC 721-3-3, unit in operation, class 3C2 IEC 721-3-3, unit in operation, class 3S2
	Altitude	100% load capacity (no derating) up to 1000 m. 1% derating for each 100 m above 1000 m; max. 2000 m
	Vibration: EN60068-2-6	3...150 Hz Displacement amplitude 1[peak] mm at 3...15.8 Hz Max acceleration amplitude 1 G at 15.8...150 Hz
	Shock IEC 68-2-27	UPS Drop Test (for applicable UPS weights) Storage and shipping: max 15 G, 11 ms (in package)
	Enclosure class	IP20 / IP21 / Nema1 for MI1-3, IP21/Nema 1 for MI4-5
Pollution degree	PD2	
EMC	Immunity	Complies with EN50082-1, -2, EN61800-3
	Emissions	230V : Complies with EMC category C2; With an internal RFI filter MI4&5 complies C2 with an optional DC choke and CM choke 400V: Complies with EMC category C2; With an internal RFI filter MI4&5 complies C2 with an optional DC choke and CM choke Both: No EMC emission protection (Vacon level N): Without RFI filter
Standards		For EMC: EN61800-3, For safety: UL508C, EN61800-5
Certificates and manufacturer's declarations of conformity		For safety: CE, UL, cUL, KC For EMC: CE, KC (see unit nameplate for more detailed approvals)

Table 10.1: Vacon 20 technical data

10.2 Power ratings

10.2.1 Vacon 20 – Mains voltage 208-240 V

Mains voltage 208-240 V, 50/60 Hz, 1~ series								
Freq. converter type	Rated loadability		Motor shaft power		Nominal input current [A]	Mechanical size	Weight (kg)	
	100% contin. current I_N [A]	150% over-load current [A]	P [HP]	P [KW]				
0001	1.7	2.6	0.33	0.25	4.2	M11	0.55	
0002	2.4	3.6	0.5	0.37	5.7	M11	0.55	
0003	2.8	4.2	0.75	0.55	6.6	M11	0.55	
0004	3.7	5.6	1	0.75	8.3	M12	0.7	
0005	4.8	7.2	1.5	1.1	11.2	M12	0.7	
0007	7	10.5	2	1.5	14.1	M12	0.7	
0009*	9.6	14.4	3	2.2	22.1	M13	0.99	

Table 10.2: Vacon 20 power ratings, 208-240 V

* The maximum ambient operating temperature of this drive is 40 °C!

Mains voltage 208 - 240 V, 50/60 Hz, 3~ series								
Freq. converter type	Rated loadability		Motor shaft power		Nominal input current [A]	Mechanical size	Weight (kg)	
	100% contin. current I_N [A]	150% over-load current [A]	P [HP]	P [KW]				
0001	1.7	2.6	0.33	0.25	2.7	M11	0.55	
0002	2.4	3.6	0.5	0.37	3.5	M11	0.55	
0003	2.8	4.2	0.75	0.55	3.8	M11	0.55	
0004	3.7	5.6	1	0.75	4.3	M12	0.7	
0005	4.8	7.2	1.5	1.1	6.8	M12	0.7	
0007*	7	10.5	2	1.5	8.4	M12	0.7	
0011*	11	16.5	3	2.2	13.4	M13	0.99	
0012	12.5	18.8	4	3	14.2	M14	9	
0017	17.5	26.3	5	4	20.6	M14	9	
0025	25	37.5	7.5	5.5	30.3	M14	9	
0031	31	46.5	10	7.5	36.6	M15	11	
0038	38	57	15	11	44.6	M15	11	

Table 10.3: Vacon 20 power ratings, 208-240 V, 3~

* The maximum ambient operating temperature of these drives is +40 °C.

10.2.2 Vacon 20 – Mains voltage 115 V

Mains voltage 115 V, 50/60 Hz, 1~ series							
Freq. converter type	Rated loadability		Motor shaft power		Nominal input current [A]	Mechanical size	Weight [Kg]
	100% contin. current I _N [A]	150% over-load current [A]	P [HP]	P [KW]			
0001	1.7	2.6	0.33	0.25	9.2	MI2	0.7
0002	2.4	3.6	0.5	0.37	11.6	MI2	0.7
0003	2.8	4.2	0.75	0.55	12.4	MI2	0.7
0004	3.7	5.6	1	0.75	15	MI2	0.7
0005	4.8	7.2	1.5	1.1	16.5	MI3	0.99

Table 10.4: Vacon 20 power ratings, 115 V, 1~

10.2.3 Vacon 20 – Mains voltage 380-480 V

Mains voltage 380-480 V, 50/60 Hz, 3~ series							
Freq. converter type	Rated loadability		Motor shaft power		Nominal input current [A]	Mechanical size	Weight (kg)
	100% contin. current I _N [A]	150% over-load current [A]	P [HP]	P [KW]			
0001	1.3	2	0.5	0.37	2.2	MI1	0.55
0002	1.9	2.9	0.75	0.55	2.8	MI1	0.55
0003	2.4	3.6	1	0.75	3.2	MI1	0.55
0004	3.3	5	1.5	1.1	4	MI2	0.7
0005	4.3	6.5	2	1.5	5.6	MI2	0.7
0006	5.6	8.4	3	2.2	7.3	MI2	0.7
0008	7.6	11.4	4	3	9.6	MI3	0.99
0009	9	13.5	5	4	11.5	MI3	0.99
0012	12	18	7.5	5.5	14.9	MI3	0.99
0016	16	24	10	7.5	17.1	MI4	9
0023	23	34.5	15	11	25.5	MI4	9
0031	31	46.5	20	15	33	MI5	11
0038	38	57	25	18.5	41.7	MI5	11

Table 10.5: Vacon 20 power ratings, 380-480 V

10.2.4 Vacon 20 – Mains voltage 600 V

Mains voltage 600 V, 50/60 Hz, 3~ series							
Frequency converter type	Rated loadability		Motor shaft power		Nominal input current [A]	Mechanical size	Weight (kg)
	100% contin. current I_N [A]	150% over-load current [A]	P [HP]	P [KW]			
0002	1,7	2,6	1	0,75	2	MI3	0,99
0003	2,7	4,2	2	1,5	3,6	MI3	0,99
0004	3,9	5,9	3	2,2	5	MI3	0,99
0006	6,1	9,2	5	4	7,6	MI3	0,99
0009	9	13,5	7,5	5,5	10,4	MI3	0,99

Table 10.6: Vacon 20 power ratings, 600 V

Note 1: The input currents are calculated values with 100 kVA line transformer supply.

Note 2: The mechanical dimensions of the units are given in Chapter 3.1.1.

Note 3: For PM motor, please select the drive power rating according to motor shaft power, not rated current.

10.3 Brake resistors

Vacon 20 type	Minimum braking resistance	Resistor type code (from Vacon NX family)		
		Light duty	Heavy duty	Resistance
MI2 204-240V, 3~	50 Ohm	-	-	-
MI2 380-480V, 3~	118 Ohm	-	-	-
MI3 204-240V, 3~	31 Ohm	-	-	-
MI3 380-480V, 3~	55 Ohm	BRR-0022-LD-5	BRR-0022-HD-5	63 Ohm
MI3 600V, 3~	100 Ohm	BRR-0013-LD-6	BRR-0013-HD-6	100 Ohm
MI4 204-240V, 3~	14 Ohm	BRR-0025-LD-2	BRR-0025-HD-2	30 Ohm
MI4 380-480V, 3~	28 Ohm	BRR-0031-LD-5	BRR-0031-HD-5	42 Ohm
MI5 204-240V, 3~	9 Ohm	BRR-0031-LD-2	BRR-0031-HD-2	20 Ohm
MI5 380-480V, 3~	17 Ohm	BRR-0045-LD-5	BRR-0045-HD-5	21 Ohm

Note! For MI2 and MI3, only 3-phase units are equipped with brake chopper.

For further information on brake resistors, please download Vacon NX Brake Resistor Manual (UD00971C) on [http://www.vacon.com/Support & Downloads](http://www.vacon.com/Support%20&%20Downloads)

VACON[®]

DRIVEN BY DRIVES

Find your nearest Vacon office
on the Internet at:

www.vacon.com

Manual authoring:
documentation@vacon.com

Vacon Plc.
Runsorintie 7
65380 Vaasa
Finland

Subject to change without prior notice
© 2013 Vacon Plc.

Document ID:



Rev. 01